



**ACOUSTIC  
INSPIRATION**

# IMPRESSUM

## CONCEPT

Amadeus Schneider | [schneiderbrett.com](http://schneiderbrett.com)  
Daniel Rohrer | [CIRKEL.ch](http://CIRKEL.ch)

## PHOTOGRAPHY

Michal Florence Schorro  
Nicolas Duc  
Sandro Mazzola (Cover Shot)  
Severin Ettl  
Terence Du Fresne  
Yosuke Kojima

## LAYOUT & GRAPHICS

Amadeus Schneider | [schneiderbrett.com](http://schneiderbrett.com)

## TEXT

Daniel Rohrer | [CIRKEL.ch](http://CIRKEL.ch)

## PRINT

Fromm Druck GmbH | [druckhaus-fromm.de](http://druckhaus-fromm.de)

## COMPANY

ECHOJAZZ AG  
Ringstrasse 25  
CH-6010 Kriens  
Schweiz  
[www.echojazz.com](http://www.echojazz.com)  
[info@echojazz.com](mailto:info@echojazz.com)  
+41 41 340 18 80  
Commercial register no.: CHE-382.449.661  
Commercial Register Office: Luzern

## VERSION

EN-20251125

## DIGITAL VERSION

[www.echojazz.com/download/brochure](http://www.echojazz.com/download/brochure)



# TABLE OF CONTENTS

<b>COMPANY PROFILE</b>	
ACOUSTIC INSPIRATION	6
SUSTAINABILITY BY DESIGN	8
ACOUSTICS AND ENVIRONMENT	10
HIGH PERFORMANCE	12
<b>ACOUSTIC MATERIAL</b>	
<b>ECHOBOARD®</b>	16
DATA SHEET ECHOBOARD® 12MM	20
COLOURS ECHOBOARD® 12MM	21
DATA SHEET ECHOBOARD® 24MM	24
COLOURS ECHOBOARD® 24MM	25
<b>ECHOACOUSTIC®</b>	26
DATA SHEET ECHOACOUSTIC® 25MM	30
COLOURS ECHOACOUSTIC® 25MM	31
<b>ECHOFLAKES®</b>	32
<b>ACOUSTIC PRODUCTS</b>	
<b>ACOUSTIC-CEILINGS</b>	37
ECHOORBIT® / ECHOLED® ORBIT	38
ECHOSAIL®	42
ECHOBaffle®	46
ECHOGRID®	50
<b>ACOUSTIC-LIGHTING</b>	57
ECHOLED® SITAS	58
ECHOLED® NOVEM	62
ECHOLED® EQ4	66
ECHOAMBIENT® COCOON	70
ECHOAMBIENT® CONE	74
ECHOLED® CONE	78
ECHOLED® UMBRA	82
ECHOLED® LINEAR	86
ECHOLED® BEAM	90
ECHOLED® BAFFLE	94
ECHOLED® LAMELLA	98
<b>ACOUSTIC-WALLS</b>	103
ECHOBaffle® WALL	104
ECHOFIELD® ORNAMENT	108
ECHOFIELD®	112
ECHOBRICK®	116
ECHOMONOC®	122
ECHOACOUSTIC® ACCENT	126
<b>ACOUSTIC-PARTITIONS</b>	131
ECHOCURTAIN®	132
ECHOTORRENT®	136
ECHOCOVE® ECO	142
ECHOCOVE® PALING	148
ECHOCOVE® STAND	152
ECHOCOVE® MOVE	156
ECHOCOVE® DESK	160
ECHOCOVE® BOW	166
<b>ACOUSTIC-FURNITURE</b>	171
ECHOCRATE®	172
ECHONOTE®	176
ECHOTOWER® SQUARE	180
ECHOTOWER® ROUND	184
MCART	188
ECHOCARRY	192
ECHOBOX®	196
ECHOSTOOL®	200
<b>ADDITIONAL ITEMS</b>	205
ECHOACOUSTIC® 25MM PROFILE	207
ECHOBaffle® CUSTOM DESIGN OPTIONS	209
ECHOLED® NOVEM SPOTS 3X3	211
ECHOLED® SITAS LIGHT-MODULE	211
ECHOLED® EQ4 PIN BY BARTENBACH	213
ECHOLED® LINEAR LED	213
ECHOCOVE® JOINER	215
ECHOCOVE® DESK ADAPTER	217
MCART ELECTRICAL SOCKET	219
ECHOCRATE® SUSPENSION PROFILE	221
ECHONOTE® 12MM COVER	223
ECHOCOVE® 24MM STAND CENTERBASE	225
<b>CREATE</b>	
<b>COLOURS</b>	229
ECHOGRID® CARVINGS	233
ECHOGRID® PERFORATIONS	237
PERFORATIONS	241
SILHOUETTE	245

Customised high-performance sound absorbers for a noticeable improvement in well-being and room quality. ECHO**JAZZ** EchoBoards® are made from recycled PET bottles. 100% Swiss design, 100% zero waste.

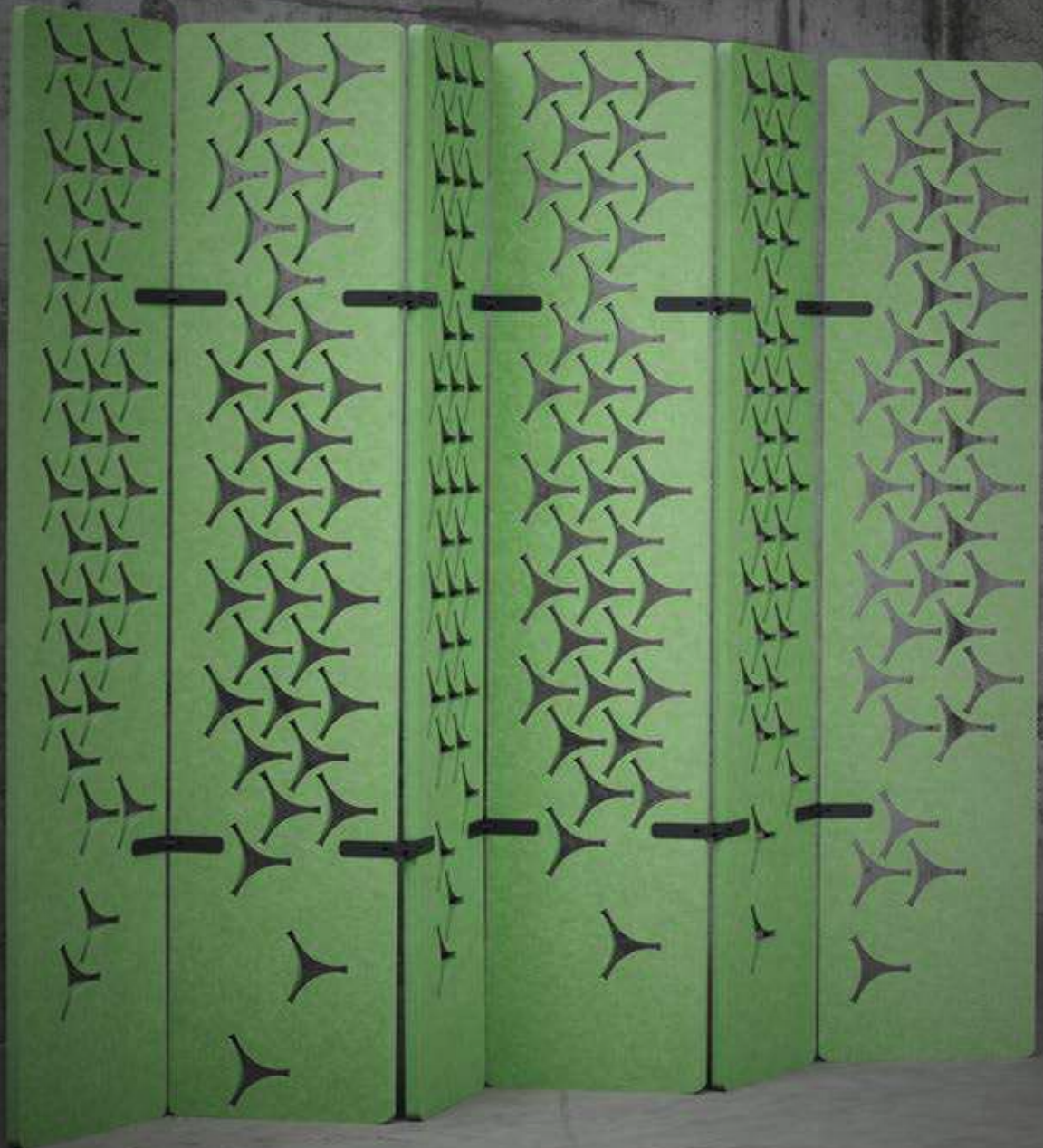



COMPANY PROFILE

MATERIAL

CEILING

LIGHTING

WALLS

PARTITIONS

FURNITURE

ADDITIONAL ITEMS

CREATE



# COMPANY PROFILE

## ACOUSTIC INSPIRATION

Ecological, robust and flexible high-performance sound absorbers made from recycled PET bottles, tailor-made for individual solutions to increase comfort and room quality in architecture, gastronomy, creative industries, open office spaces, school buildings, swimming pools, hotelery and your home. 100% Swiss design, 100% zero waste.

Made from 74 PET bottles per square metre, we process our **ECHOJAZZ** EchoBoards® into functional design elements. The soft, felt-like feel matches a wide range of natural materials such as stone, concrete, wood, metal and glass. **ECHOJAZZ** products are fire protection certified and available in up to 34 colours. Staged as a real eye-catcher or cleverly concealed - **ECHOJAZZ** improves the feeling of space in a noticeably pleasant way and with a lasting effect.



ECHOCURTAIN®



ECHOCOVE® DESK



ECHOTOWER®



## SUSTAINABILITY BY DESIGN

To noticeably improve well-being and room quality, we create high-performance sound absorbers for architecture, gastronomy, creative industries, open office spaces and your home. Our ready-made products are designed for you in Kriens and have the highest standards of design and simplicity.

**More ecological, more robust and more flexible in use than any other comparable product:** all our products are based on the use of durable high-tech felt made from 100% PET. It was our upmost goal to ensure that the ECHOJAZZ products contain the highest possible proportion of recycled PET material and that the result is deceptively close to the beauty and properties of traditional wool.

**Our product is for your project:** We take care of individual and tailor-made solutions that address a wide range of projects and offer a large range of smart standard products.

**And after the project is before the project:** Through our stewardship programme, we can recycle 100% of used ECHOJAZZ products.

COMPANY PROFILE

MATERIAL

CEILING

LIGHTING

WALLS

PARTITIONS

FURNITURE

ADDITIONAL ITEMS

CREATE

## ACOUSTICS AND ENVIRONMENT

At ECHOJAZZ, we combine sustainability with the simplicity of design of highest and most vanguard standards. In order not to burden our nature, only the cycle comes into question for us: recycled raw materials, recyclable products, zero waste.

From disposable plastic to high-quality end products for the design industry: for our products we use 100% PET with a minimum of 50% recycled PET. Compared to the production of virgin PET, the use of recycled PET saves up to 84% of the energy. Individual products are complemented with recycled and recyclable steel

**Closed loop:** ECHOJAZZ is the only manufacturer to offer a take-back programme for all products. This means that all products can be returned for recycling at the end of their life cycle.

**100% Zero Waste:** We generate raw material for new products from used products and the residual material created during production.

**On to the emission-free future:** ECHOJAZZ products are already processed locally in Kriens, and we aim to have as many raw materials as possible manufactured as close to our site as possible.





ECHOTOWER®



FILLING MATERIAL

WASTE STEWARDSHIP PROGRAMME

ZERO WASTE



ECHOFLAKES®

SHREDDING

OLD ECHOJAZZ PRODUCTS PRODUCTION OFFCUTS

CLING



BOARD®

## HIGH PERFORMANCE

The world is changing at breakneck speed: space and tranquillity are becoming rare commodities. Whether in a creative open office, in a simple waiting room or in trendy restaurant concepts - people should feel comfortable in all rooms. We offer solutions that improve heavily frequented and acoustically stressed rooms: noticeably, audibly, sustainably.

**Design without compromise:** The time of carpet wallpaper and thick curtains in dim conference rooms is over. We will contain acoustic disturbance elements in every room without restricting modern design visions and architecture.

**Sustainability without compromise:** The construction industry is one of the biggest waste generators on our planet. This must change. We start with a product that is 100% recyclable. We achieve the UN Sustainable Development Goals (SDGs) for responsible consumption and production.

**Unlimited inspiration:** It is in the hands of the creative industries to reinvent flawed materials, products and business models, to model sustainability and inspire people. Let's get started!



### SOUND-ABSORBING

The open and compressed felt structure is 40% thinner than comparable high-performance absorbers.



### ROBUST

Very dimensionally stable, tear-resistant and cleanable without residues.



### REGULATING

Pleasant indoor climate thanks to balancing temperature and humidity.



### EASY TO PROCESS

Individually cut on the CNC cutting plotter, easily customisable on site.



### FIRE SAFETY

European fire protection classification: B-s1/s2, d0, hardly any smoke development and no burning dripping.



### MOLD-FREE

Because the fibre does not absorb water, the EchoBoard® dries very well.



### EMISSION-FREE

Does not emit hazardous fibres or paint particles.



### LIGHTFASTNESS

The fibres are dyed in the liquid state and do not fade.



The robust and easy-care basic elements EchoBoard® and EchoCoustic® can be used for a large number of individual design ideas and allow creative wishes regarding shapes, colours, perforation and areas of application.



COMPANY PROFILE

MATERIAL

CEILING

LIGHTING

WALLS

PARTITIONS

FURNITURE

ADDITIONAL ITEMS

CREATE

# ACOUSTIC MATERIAL

# ECHObOARD®

EchoBoard® is the basic material for optimal room acoustics. All ECHO**JAZZ** acoustic ceilings, acoustic luminaires, acoustic walls and acoustic room dividers are produced from this absorber. It can be processed in many ways to meet ever new creations and customer requirements. The ECHO**JAZZ** development team is happy to help develop customised solutions according to design proposals or DWG cutting plans. There is a choice of the classic 24mm or thinner 12mm. ECHO**JAZZ** offers its own mounting kits for easy installation.



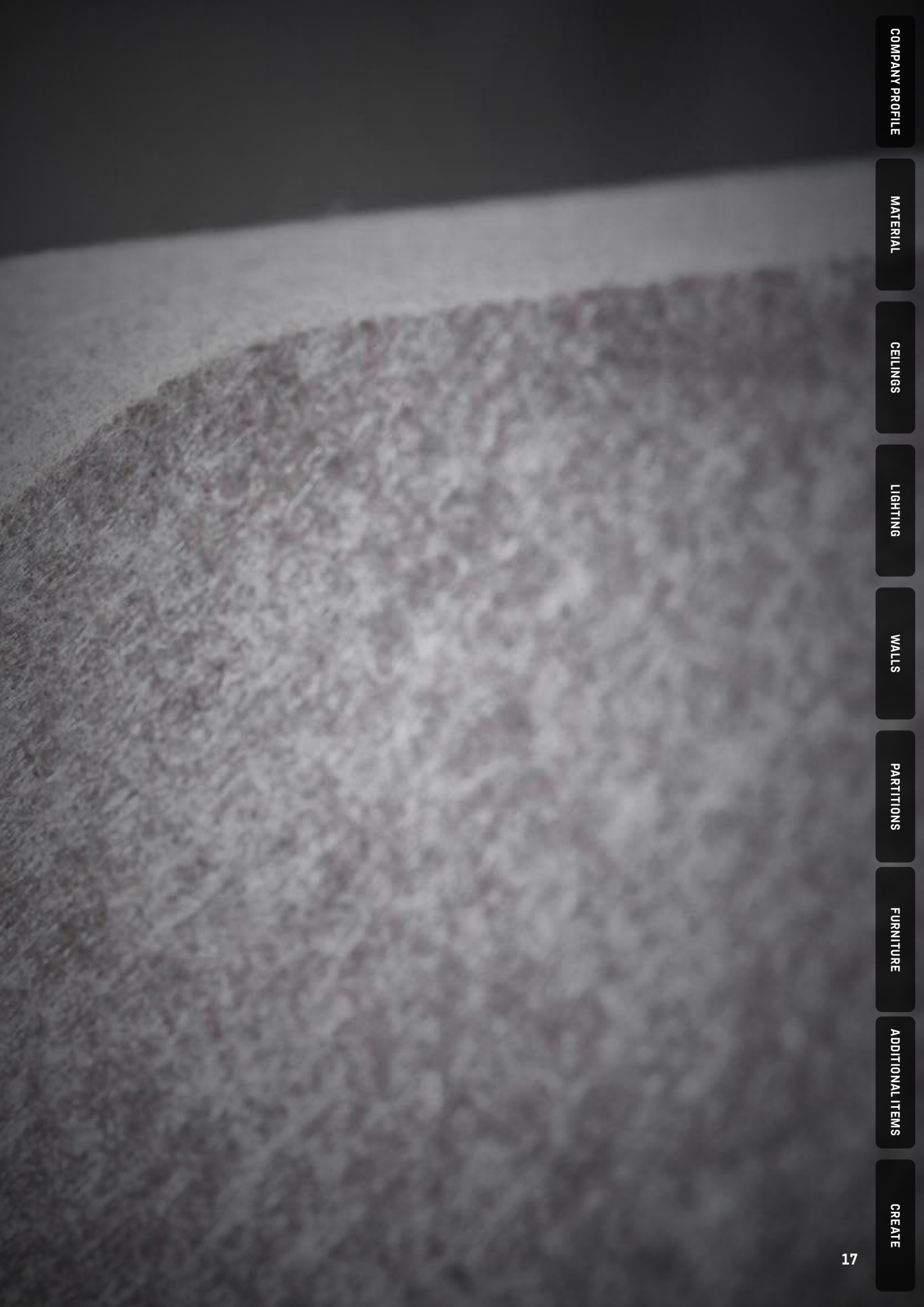

COMPANY PROFILE

MATERIAL

CEILING

LIGHTING

WALLS

PARTITIONS

FURNITURE

ADDITIONAL ITEMS

CREATE

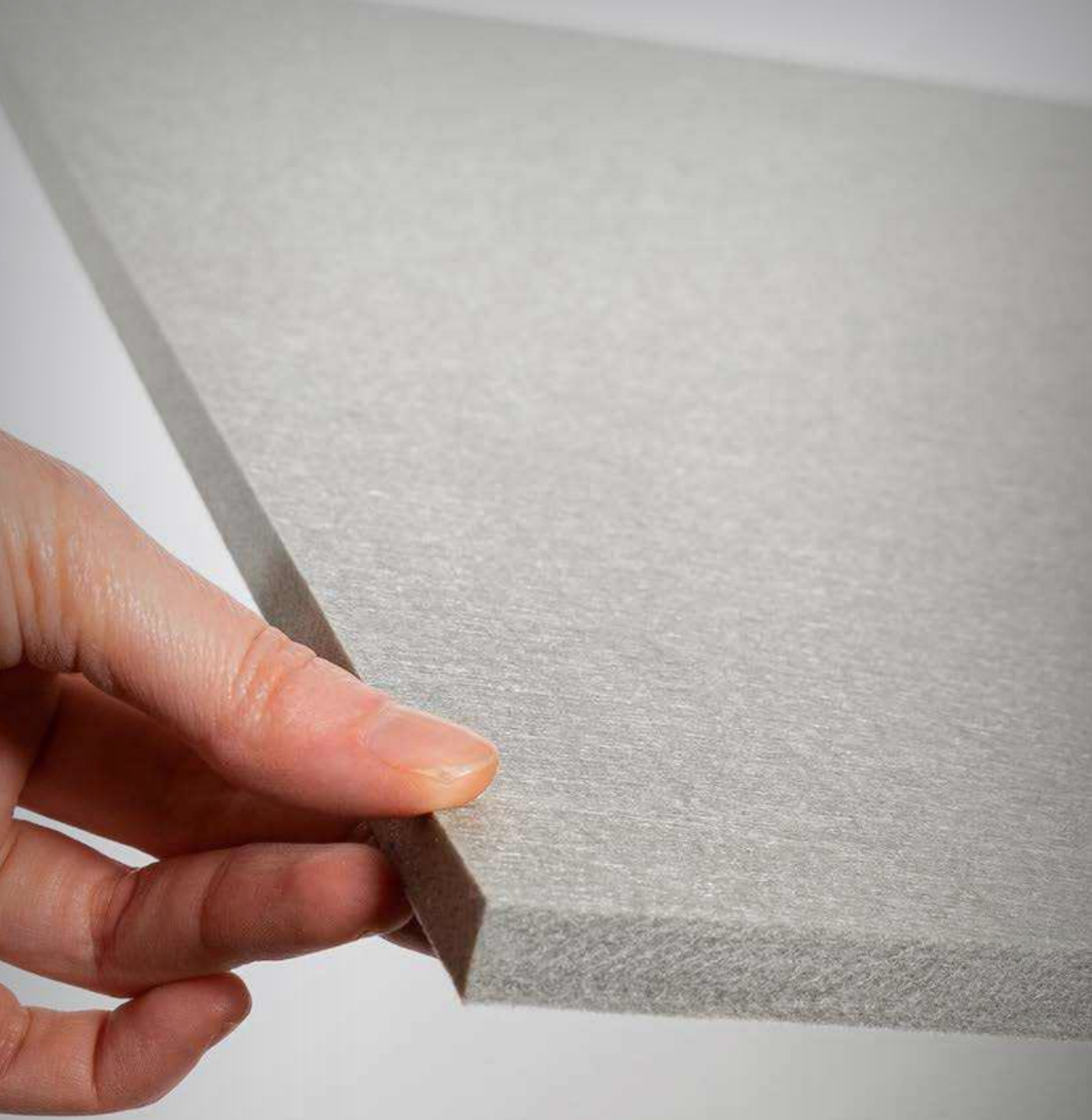

# ECHOBOARD® 12MM

EchoBoard® 12mm is a high-quality sound absorber with an  $\alpha_w$  of up to 0.90 and a NRC of up to 0.85, which can be used for ceilings, walls, on tables or freely in space.

Absorption coefficient: [aw 0.90](#), class A

NAME	ARTICLE	W x H x D (in mm)	UNIT	PET-BOTTLES
EchoBoard® 12mm	1001	1200x2800x12	1 Pce	168

ECHOBOARD® 12MM

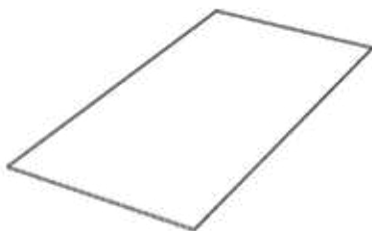

COMPANY PROFILE

MATERIAL

CEILING

LIGHTING

WALLS

PARTITIONS

FURNITURE

ADDITIONAL ITEMS

CREATE

# DATA SHEET ECHOBOARD® 12MM

EchoBoard® 12mm is a high quality sound absorber with an aw of up to 0.90 and a NRC of up to 0.85, which can be used for acoustic ceilings, walls, office desks or room dividers.

<b>NAME</b>	EchoBoard® 12mm																												
<b>DIMENSIONS</b>	1200mm (± 1mm) x 2800mm (± 1mm)																												
<b>COMPOSITION</b>	100% PET (> 50% recycled PET)																												
<b>PET-BOTTLES* PER PANEL</b>	168 PET-Bottles *The number of PET bottles refers to 500ml PET bottles with a bottle weight of 24g.																												
<b>WEIGHT</b>	2400g/m <sup>2</sup> (± 10%)																												
<b>MATERIAL THICKNESS</b>	12mm																												
<b>LIGHT FASTNESS ISO 105-B02-1994</b>	> 7																												
<b>FIRE PROTECTION EN 13501</b>	B-s1, d0																												
<b>VOC EMISSIONS ASTM D5116</b>	< 0.5mg/m <sup>2</sup> /h																												
<b>FORMALDEHYDE EMISSIONS ASTM D5116</b>	< 0.1mg/m <sup>2</sup> /h																												
<b>ENVIRONMENTAL CERTIFICATES</b>	eco1 Minergie-Eco Cradle to Cradle Certified® Bronze M1 emission-free materials																												
<b>ABSORPTION COEFFICIENT DIN EN ISO 11654 ASTM C423</b>	aw 0.30 (direct mounting) aw 0.60 (50mm wall/ceiling distance) aw 0.90 (200mm wall/ceiling distance)  NRC = 0.45 (direct mounting) NRC = 0.70 (50mm wall/ceiling distance) NRC = 0.85 (200mm wall/ceiling distance)																												
<b>COLOURS</b>	> 10																												
<b>ABSORPTION GRAPH</b>	<p>The graph plots the Sound Absorption Coefficient (Y-axis, 0.00 to 1.20) against Frequency in Hertz (X-axis, 125 to 4000). Three data series are shown: direct mount (green line), 50mm distance (yellow line), and 200mm distance (blue line). All series show an overall upward trend with frequency, with the 200mm distance configuration consistently providing the highest absorption across the measured range.</p> <table border="1"> <caption>Approximate data points from the Absorption Graph</caption> <thead> <tr> <th>Frequency (Hz)</th> <th>Direct Mount (aw)</th> <th>50mm Distance (aw)</th> <th>200mm Distance (aw)</th> </tr> </thead> <tbody> <tr> <td>125</td> <td>0.02</td> <td>0.10</td> <td>0.52</td> </tr> <tr> <td>250</td> <td>0.05</td> <td>0.25</td> <td>0.80</td> </tr> <tr> <td>500</td> <td>0.20</td> <td>0.60</td> <td>0.95</td> </tr> <tr> <td>1000</td> <td>0.50</td> <td>0.90</td> <td>0.80</td> </tr> <tr> <td>2000</td> <td>0.80</td> <td>0.95</td> <td>0.90</td> </tr> <tr> <td>4000</td> <td>0.85</td> <td>0.90</td> <td>0.95</td> </tr> </tbody> </table>	Frequency (Hz)	Direct Mount (aw)	50mm Distance (aw)	200mm Distance (aw)	125	0.02	0.10	0.52	250	0.05	0.25	0.80	500	0.20	0.60	0.95	1000	0.50	0.90	0.80	2000	0.80	0.95	0.90	4000	0.85	0.90	0.95
Frequency (Hz)	Direct Mount (aw)	50mm Distance (aw)	200mm Distance (aw)																										
125	0.02	0.10	0.52																										
250	0.05	0.25	0.80																										
500	0.20	0.60	0.95																										
1000	0.50	0.90	0.80																										
2000	0.80	0.95	0.90																										
4000	0.85	0.90	0.95																										

# COLOURS ECHOBORD® 12MM

Due to the nature of the material, surface and colour deviations are possible.

## ECHOBORD® 12MM

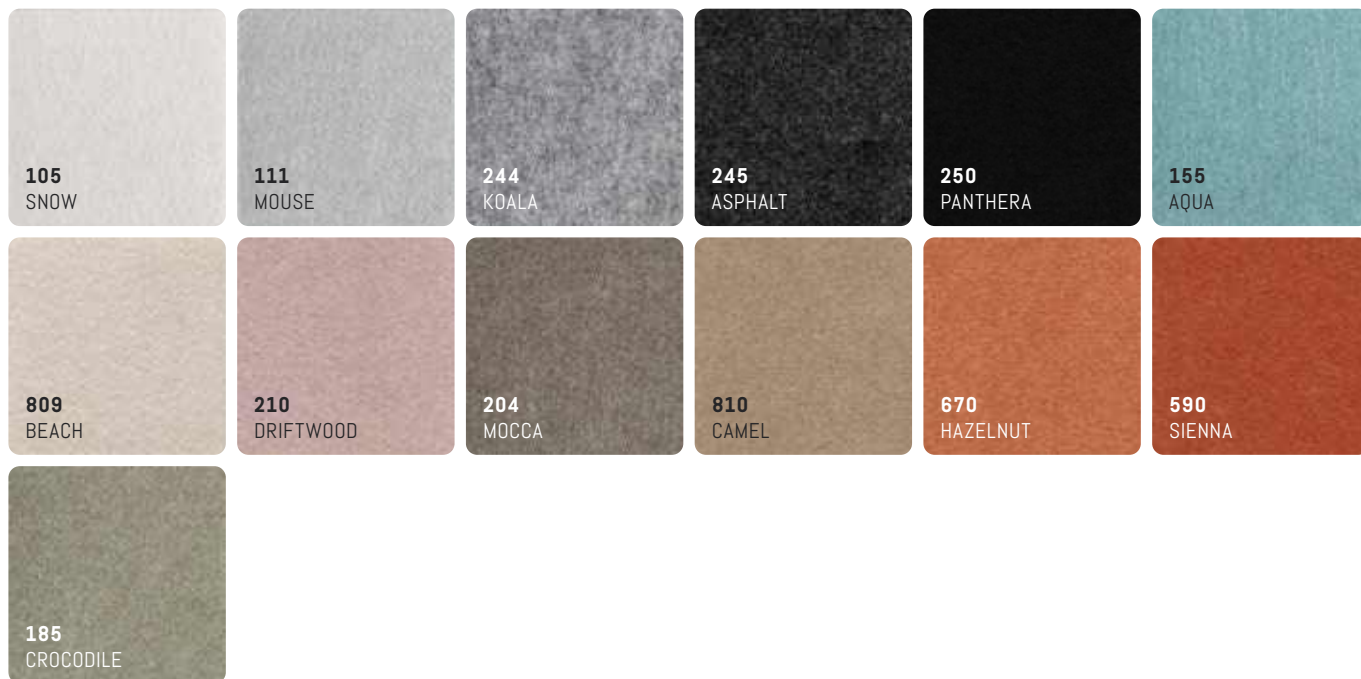

COMPANY PROFILE

MATERIAL

CEILING

LIGHTING

WALLS

PARTITIONS

FURNITURE

ADDITIONAL ITEMS

CREATE



# ECHOBOARD® 24MM

EchoBoard® 24mm is a high-quality sound absorber with an aw of up to 1.00 and a NRC of up to 0.95, which can be used for ceilings, walls, on tables or freely in space.

Absorption coefficient: [aw 1.00](#), class A

NAME	ARTICLE	W x H x D (in mm)	UNIT	PET-BOTTLES
EchoBoard® 24mm	1003	1800x2400x24	1 pce	303

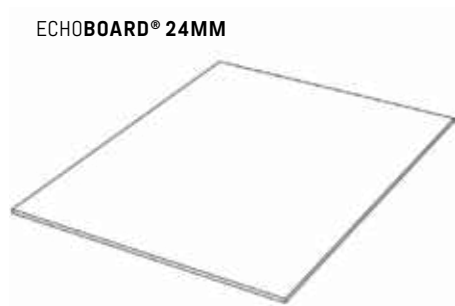

- COMPANY PROFILE
- MATERIAL
- CEILING
- LIGHTING
- WALLS
- PARTITIONS
- FURNITURE
- ADDITIONAL ITEMS
- CREATE

# DATA SHEET ECHOBOARD® 24MM

EchoBoard® 24mm is a high quality sound absorber with an aw of up to 1.00 and a NRC of up to 0.95, which can be used for acoustic ceilings, walls, office desks or room dividers.

<b>DESCRIPTION</b>	EchoBoard® 24mm																												
<b>DIMENSIONS</b>	1800mm (± 1mm) x 2400mm (± 1mm)																												
<b>COMPOSITION</b>	100% PET (> 50% recycled PET)																												
<b>PET BOTTLES* PER PANEEL</b>	303 PET Bottles *The number of PET bottles refers to 500ml PET bottles with a bottle weight of 24g.																												
<b>WEIGHT</b>	3600g/m <sup>2</sup> (± 10%)																												
<b>MATERIAL THICKNESS</b>	24mm																												
<b>LIGHTFASTNESS ISO 105-B02-1994</b>	> 7																												
<b>FIRE TEST EN 13501</b>	B-s1, d0																												
<b>VOC EMISSIONS ASTM D5116</b>	< 0.5mg/m <sup>2</sup> /h																												
<b>FORMALDEHYDE EMISSIONS ASTM D5116</b>	< 0.1mg/m <sup>2</sup> /h																												
<b>ENVIRONMENTAL CERTIFICATIONS</b>	eco1 Minergie-Eco Cradle to Cradle Certified® Bronze M1 emission-free materials																												
<b>SOUND ABSORPTION DIN EN ISO 11654 ASTM C423</b>	aw 0.50 (direct mount) aw 0.65 (50mm wall/ceiling distance) aw 1.00 (200mm wall/ceiling distance)  NRC = 0.70 (direct mount) NRC = 0.80 (50mm wall/ceiling distance) NRC = 0.95 (200mm wall/ceiling distance)																												
<b>COLOURS</b>	> 20																												
<b>SOUND ABSORPTION GRAPH</b>	<p>The graph displays the sound absorption coefficient across a frequency range of 125 Hz to 4000 Hz. Three data series are shown: direct mount (green), 50mm distance (yellow), and 200mm distance (blue). The 200mm distance series consistently shows the highest absorption, peaking at approximately 1.05 at 2000 Hz. The 50mm distance series peaks at about 1.00 at 1000 Hz, and the direct mount series peaks at about 0.95 at 2000 Hz.</p> <table border="1"> <caption>Approximate data points from the Sound Absorption Graph</caption> <thead> <tr> <th>Frequency (Hz)</th> <th>Direct Mount (Green)</th> <th>50mm Distance (Yellow)</th> <th>200mm Distance (Blue)</th> </tr> </thead> <tbody> <tr> <td>125</td> <td>0.02</td> <td>0.15</td> <td>0.52</td> </tr> <tr> <td>250</td> <td>0.18</td> <td>0.35</td> <td>0.85</td> </tr> <tr> <td>500</td> <td>0.65</td> <td>0.85</td> <td>0.95</td> </tr> <tr> <td>1000</td> <td>0.85</td> <td>1.00</td> <td>0.85</td> </tr> <tr> <td>2000</td> <td>0.95</td> <td>0.95</td> <td>0.95</td> </tr> <tr> <td>4000</td> <td>0.95</td> <td>0.95</td> <td>0.95</td> </tr> </tbody> </table>	Frequency (Hz)	Direct Mount (Green)	50mm Distance (Yellow)	200mm Distance (Blue)	125	0.02	0.15	0.52	250	0.18	0.35	0.85	500	0.65	0.85	0.95	1000	0.85	1.00	0.85	2000	0.95	0.95	0.95	4000	0.95	0.95	0.95
Frequency (Hz)	Direct Mount (Green)	50mm Distance (Yellow)	200mm Distance (Blue)																										
125	0.02	0.15	0.52																										
250	0.18	0.35	0.85																										
500	0.65	0.85	0.95																										
1000	0.85	1.00	0.85																										
2000	0.95	0.95	0.95																										
4000	0.95	0.95	0.95																										

# COLOURS ECHOBOARD® 24MM

Due to the nature of the material, surface and colour deviations are possible.

## ECHOBOARD® 24MM



\*Discontinued. Colour available from stock while supplies last or on request with a minimum order quantity.



# ECHOCOUSTIC®

The special EchoCoustic® absorber is the ideal material for direct mounting on walls or ceilings without spacing or substructure. The 3-layer EchoCoustic® achieves an excellent absorption levels of  $\alpha_w$  0.80 and NRW 0.85 with a thickness of only 25mm. EchoCoustic® can be easily applied with spray adhesive, the white core material remains intentionally visible or concealed by a profile frame. EchoCoustic® is available in 34 colours, as an additional design element a two-colour effect can be created by spacing the panels.



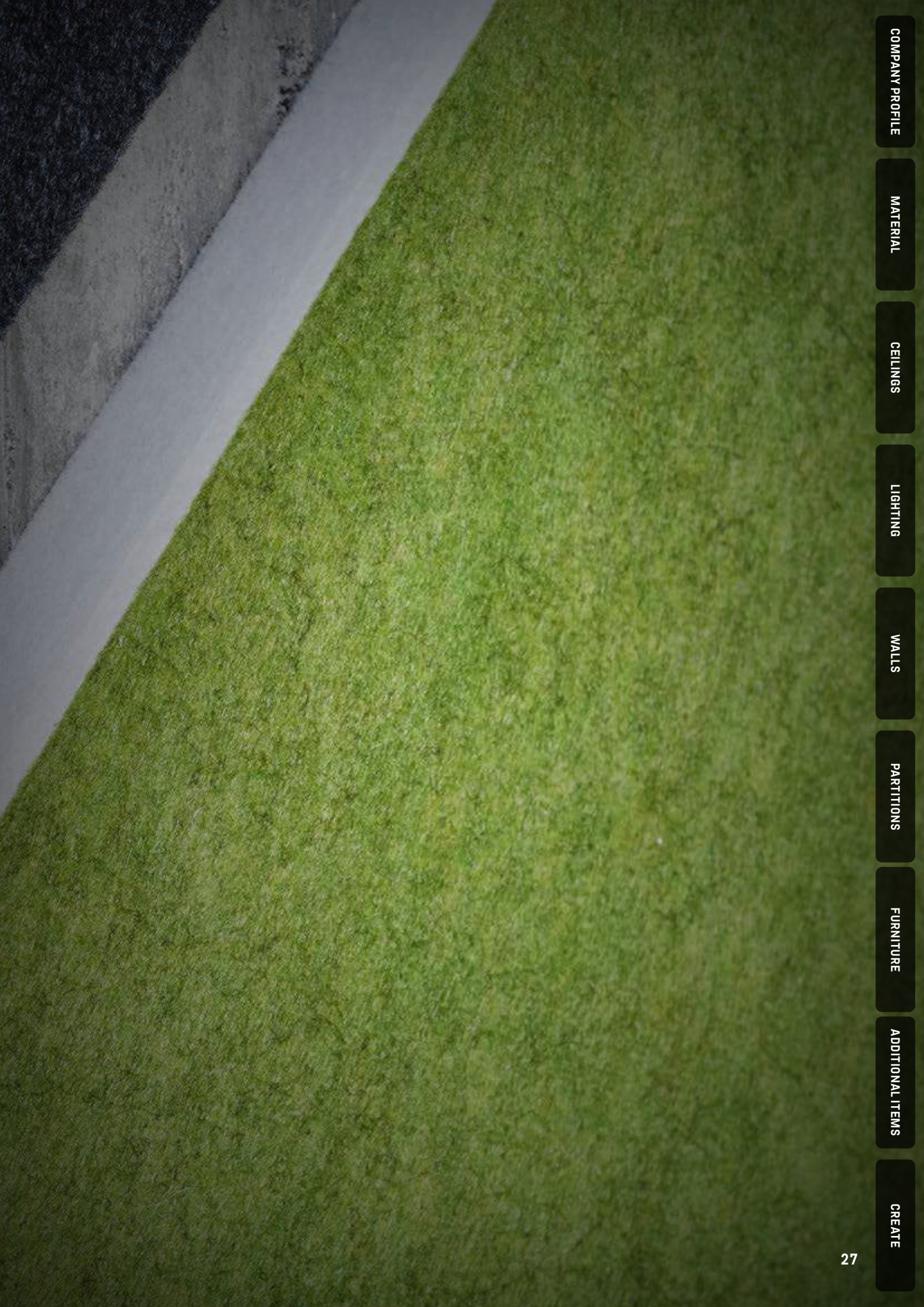

COMPANY PROFILE

MATERIAL

CEILING

LIGHTING

WALLS

PARTITIONS

FURNITURE

ADDITIONAL ITEMS

CREATE



# ECHOCOUSTIC® 25MM

EchoCoustic® 25mm is a high quality sound absorber with an aw of up to 0.90 and a NRC of up to 0.90, which can be mounted on walls and ceilings without spacing.

Absorption coefficient: aw 0.90, class A

Discover our EchoCoustic® 25mm PROFILE edge profiles! ([Page 207](#))

NAME	COLOUR	ARTICLE	W x H x D (in mm)	UNIT	PET-BOTTLES
EchoCoustic® 25mm	124	1004-124	1190x2700x25	1 pce	177
EchoCoustic® 25mm	130	1004-130	1190x2700x25	1 pce	177
EchoCoustic® 25mm	137	1004-137	1190x2700x25	1 pce	177
EchoCoustic® 25mm	141	1004-141	1190x2700x25	1 pce	177
EchoCoustic® 25mm	142	1004-142	1190x2700x25	1 pce	177
EchoCoustic® 25mm	143	1004-143	1190x2700x25	1 pce	177
EchoCoustic® 25mm	144	1004-144	1190x2700x25	1 pce	177
EchoCoustic® 25mm	145	1004-145	1190x2700x25	1 pce	177
EchoCoustic® 25mm	152	1004-152	1190x2700x25	1 pce	177
EchoCoustic® 25mm	154	1004-154	1190x2700x25	1 pce	177
EchoCoustic® 25mm	160	1004-160	1190x2700x25	1 pce	177
EchoCoustic® 25mm	164	1004-164	1190x2700x25	1 pce	177
EchoCoustic® 25mm	166	1004-166	1190x2700x25	1 pce	177
EchoCoustic® 25mm	168	1004-168	1190x2700x25	1 pce	177
EchoCoustic® 25mm	202	1004-202	1190x2700x25	1 pce	177
EchoCoustic® 25mm	227	1004-227	1190x2700x25	1 pce	177
EchoCoustic® 25mm	238	1004-238	1190x2700x25	1 pce	177
EchoCoustic® 25mm	239	1004-239	1190x2700x25	1 pce	177
EchoCoustic® 25mm	914	1004-914	1190x2700x25	1 pce	177
EchoCoustic® 25mm	915	1004-915	1190x2700x25	1 pce	177
EchoCoustic® 25mm	916	1004-916	1190x2700x25	1 pce	177
EchoCoustic® 25mm	917	1004-917	1190x2700x25	1 pce	177
EchoCoustic® 25mm	923	1004-923	1190x2700x25	1 pce	177
EchoCoustic® 25mm	925	1004-925	1190x2700x25	1 pce	177
EchoCoustic® 25mm	929	1004-929	1190x2700x25	1 pce	177
EchoCoustic® 25mm	941	1004-941	1190x2700x25	1 pce	177
EchoCoustic® 25mm	946	1004-946	1190x2700x25	1 pce	177
EchoCoustic® 25mm	948	1004-948	1190x2700x25	1 pce	177
EchoCoustic® 25mm	953	1004-953	1190x2700x25	1 pce	177
EchoCoustic® 25mm	966	1004-966	1190x2700x25	1 pce	177
EchoCoustic® 25mm	991	1004-991	1190x2700x25	1 pce	177

ECHOCOUSTIC® 25MM

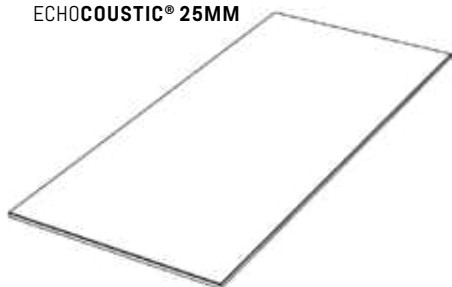

# DATA SHEET ECHOCOUSTIC® 25MM

EchoCoustic® is a high quality sound absorber with an aw of up to 0.90 and a NRC of up to 0.90, which can be mounted on walls and ceilings without spacing.

<b>NAME</b>	EchoCoustic® 25mm																					
<b>DIMENSIONS</b>	1190mm (± 1mm) x 2700mm (± 1mm)																					
<b>COMPOSITION</b>	100% PET (<50% recycled PET)																					
<b>PET-BOTTLES* PER PANEL</b>	177 PET-Bottles *The number of PET bottles refers to 500ml PET bottles with a bottle weight of 24g.																					
<b>WEIGHT</b>	2650g/m <sup>2</sup> (± 10%)																					
<b>MATERIAL THICKNESS</b>	25mm (± 2mm)																					
<b>LIGHT FASTNESS ISO 105-B02</b>	> 6																					
<b>FIRE PROTECTION EN 13501</b>	B-s1, d0																					
<b>VOC EMISSIONS CA 01350</b>	TVOC Emission Rate: 0.009 mg/m <sup>3</sup>																					
<b>FORMALDEHYDE EMISSIONS CA 01350</b>	Formaldehyde Emission Rate: <0.5 µg/m <sup>3</sup>																					
<b>ENVIRONMENTAL CERTIFICATIONS</b>	eco1 Minergie-Eco Greentag GreenRate Level A M1 emission-free materials																					
<b>ABSORPTION LEVEL ISO 11654 ASTM C423</b>	aw = 0.80 (direct mount) aw = 0.90 (400mm wall/ceiling distance)  NRC = 0.85 (direct mount) NRC = 0.90 (400mm wall/ceiling distance)																					
<b>COLOURS</b>	31																					
<b>ABSORPTION GRAPH</b>	<p>The graph plots the Sound Absorption Coefficient (Y-axis, 0.00 to 1.20) against Frequency in Hertz (X-axis, 125 to 4000). Two lines are shown: a green line for 'direct mount' and an orange line for '400mm' distance. The green line starts at ~0.10 at 125 Hz and rises to ~1.05 at 2000 Hz. The orange line starts at ~0.75 at 125 Hz, peaks at ~0.90 at 300 Hz, dips to ~0.75 at 500 Hz, and then rises to ~1.00 at 2000 Hz.</p> <table border="1"> <caption>Approximate data points from the Absorption Graph</caption> <thead> <tr> <th>Frequency (Hz)</th> <th>Direct Mount (aw)</th> <th>400mm (aw)</th> </tr> </thead> <tbody> <tr><td>125</td><td>0.10</td><td>0.75</td></tr> <tr><td>250</td><td>0.45</td><td>0.90</td></tr> <tr><td>500</td><td>0.85</td><td>0.75</td></tr> <tr><td>1000</td><td>1.05</td><td>0.90</td></tr> <tr><td>2000</td><td>1.05</td><td>1.00</td></tr> <tr><td>4000</td><td>1.05</td><td>0.95</td></tr> </tbody> </table>	Frequency (Hz)	Direct Mount (aw)	400mm (aw)	125	0.10	0.75	250	0.45	0.90	500	0.85	0.75	1000	1.05	0.90	2000	1.05	1.00	4000	1.05	0.95
Frequency (Hz)	Direct Mount (aw)	400mm (aw)																				
125	0.10	0.75																				
250	0.45	0.90																				
500	0.85	0.75																				
1000	1.05	0.90																				
2000	1.05	1.00																				
4000	1.05	0.95																				

# COLOURS ECHOCOUSTIC® 25MM

Due to the nature of the material, surface and colour deviations are possible.

## ECHOCOUSTIC® 25MM CATEGORY I



## ECHOCOUSTIC® 25MM CATEGORY II



- COMPANY PROFILE
- MATERIAL
- CEILING
- LIGHTING
- WALLS
- PARTITIONS
- FURNITURE
- ADDITIONAL ITEMS
- CREATE

## ECHOFLAKES®

With the Zero Waste goal, ECHO**JAZZ** products are taken back and shredded together with offcuts into EchoFlakes®. Filled with these flakes, the EchoTower® increases the acoustic well-being and closes the material cycle of the ECHO**JAZZ** products.



COMPANY PROFILE

MATERIAL

CEILING

LIGHTING

WALLS

PARTITIONS

FURNITURE

ADDITIONAL ITEMS

CREATE

Customised high-performance sound absorbers for a noticeable improvement in well-being and room quality. ECHO**JAZZ** products are made from recycled PET bottles. 100% Swiss design, 100% zero waste.





COMPANY PROFILE

MATERIAL

CEILING

LIGHTING

WALLS

PARTITIONS

FURNITURE

ADDITIONAL ITEMS

CREATE



# ACOUSTIC PRODUCTS

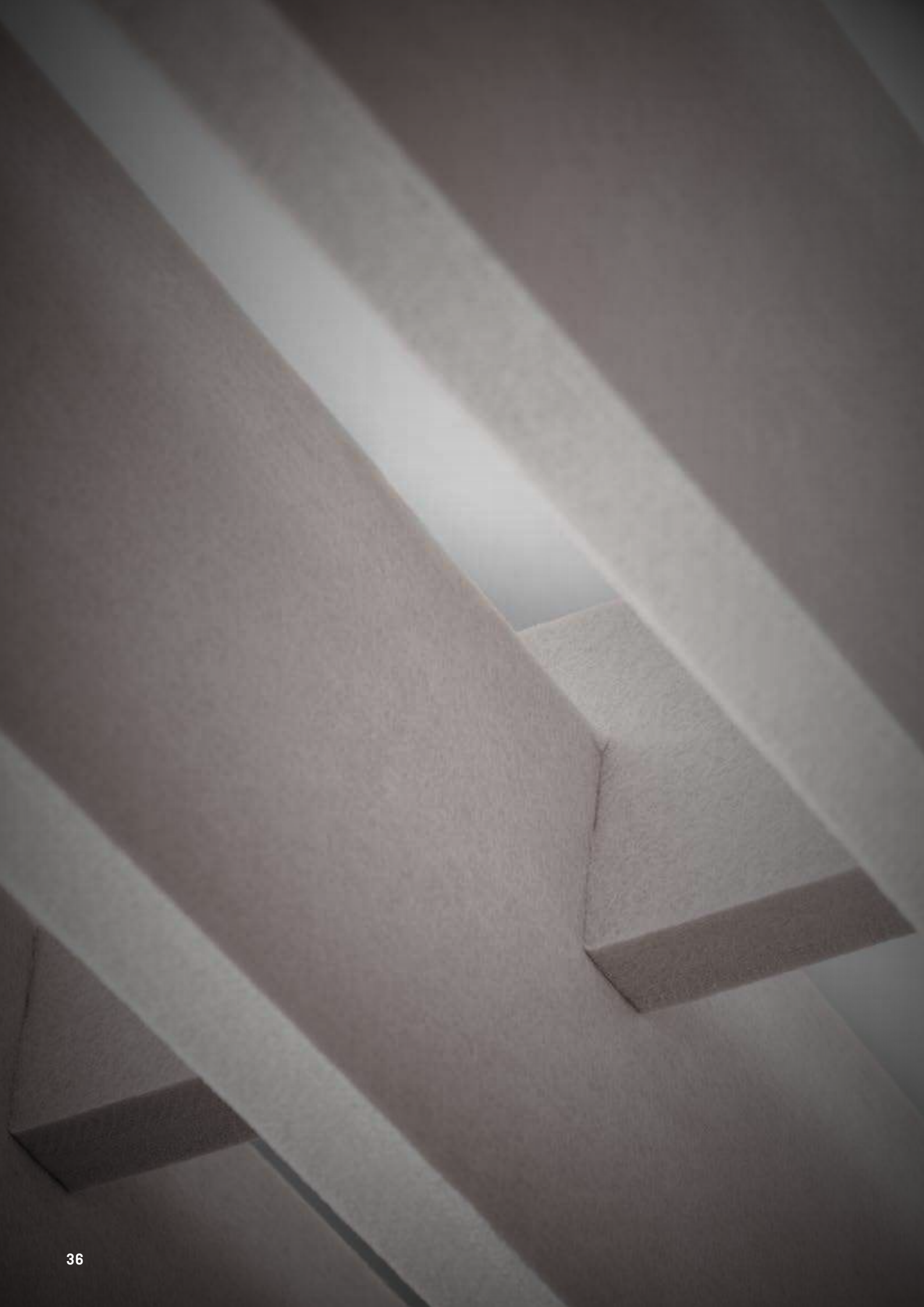



COMPANY PROFILE

MATERIAL

CEILING

LIGHTING

WALLS

PARTITIONS

FURNITURE

ADDITIONAL ITEMS

CREATE

## ACOUSTIC-CEILING

Ceilings of rooms often offer the most space for optimising room acoustics. ECHO**JAZZ** acoustic ceilings allow sound absorption for the highest demands, are adapted to the millimetre and can be optimally integrated into any room architecture.

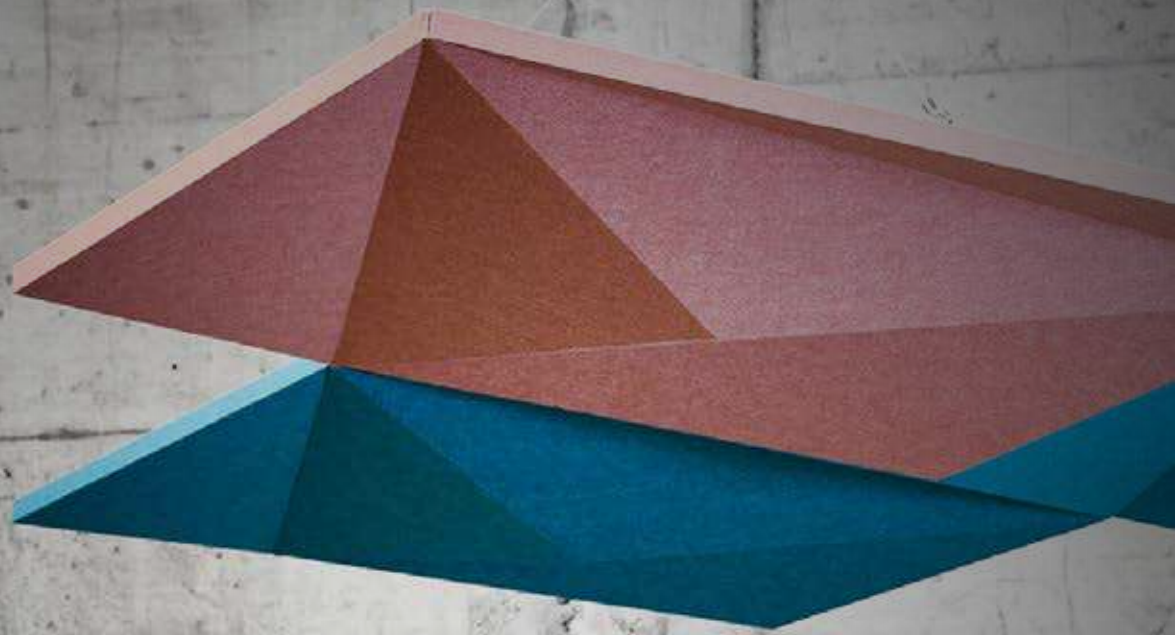

## ECHOORBIT® / ECHOLED® ORBIT

The EchoOrbit® ceiling sail is the perfect solution to acoustical calm noisy rooms. Three-dimensional diamond facets dampen the noise level and act as a diffuser for sound waves. Additional elements can be added seamlessly thanks to the hexagonal shape, allowing for stunning ceiling designs with spectacular arrangements and colour combinations. Installation is efficient thanks to only one height-adjustable suspension per element and supplied fasteners.

Say goodbye to unwanted noise and immerse yourself in a heavenly, futuristic silence with EchoOrbit®.



COMPANY PROFILE

MATERIAL

CEILING

LIGHTING

WALLS

PARTITIONS

FURNITURE

ADDITIONAL ITEMS

CREATE

# ECHOORBIT® 24MM / ECHOLED® 24MM ORBIT

Acoustic absorber for ceilings with or without light with textile surface made from 100% PET. EchoOrbit® and EchoLED® ORBIT is suspended with safety hooks.

Please specify suspension type when ordering.

Absorption coefficient:  $\alpha_w$  1.00, class A

NAME	ARTICLE	W x H x D (in mm)	UNIT	PET-BOTTLES
2x EchoOrbit® 24mm*	1585	1100x1270x109	Set of 2 pce	169
1x EchoOrbit® 24mm* + 1x EchoLED® ORBIT*	1589	1100x1270x109	Set of 2 pce	169

\*Please specify if each element (EchoOrbit® or EchoLED® ORBIT) should be suspended with 3 independent suspension points or by one bundled suspension point.

**ECHOORBIT® 24MM  
THREE SUSPENSION POINTS**

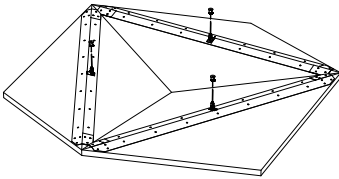

**ECHOORBIT® 24MM  
ONE SUSPENSION POINT**

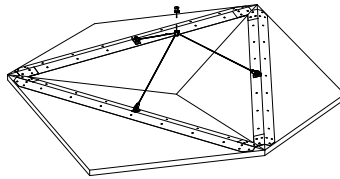

**ECHOLED® ORBIT 24MM  
THREE SUSPENSION POINTS**

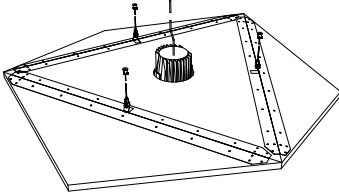

**ECHOLED® ORBIT 24MM  
ONE SUSPENSION POINT**

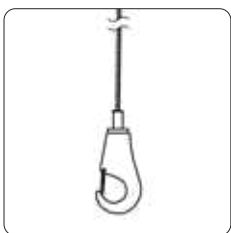
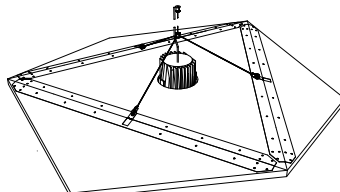

**SAFETY HOOK**



COMPANY PROFILE

MATERIAL

CEILING

LIGHTING

WALLS

PARTITIONS

FURNITURE

ADDITIONAL ITEMS

CREATE



## ECHOSAIL®

Acoustic sails are the key to defining room design and improving acoustics over large areas without affecting the layout of the room. The lightweight and maintenance-free elements can be cut to any shape and angle. The EchoSail® is screwed directly and suspended horizontally up to a length of 1000 mm; larger panels are suspended with frames and safety hooks.



COMPANY PROFILE

MATERIAL

CEILING

LIGHTING

WALLS

PARTITIONS

FURNITURE

ADDITIONAL ITEMS

CREATE

# ECHOSAIL® 12MM

Acoustic sails in various shapes and surface designs incl. suspension system up to 1500mm. The EchoSail® is suspended directly with screws up to a length of 1000mm. For all shapes over 1000mm long, the EchoSail® is suspended with a frame and safety hooks. The frame is white as standard and can be supplied in other colours to order.

Absorption coefficient:  $\alpha_w$  0.90, class A

Edge finish: 90°, corner radius 200mm

NAME	ARTICLE	W x H x D (in mm)	UNIT	PET-BOTTLES
EchoSail® 12mm BUTTERFLY	1063	1091x811x49	3 pce	109
EchoSail® 12mm HEXAGON	1064	1180x1078x62	2 pce	99
EchoSail® 12mm RECTANGLE	1065	2400x1200x62	1 pce	140
EchoSail® 12mm ROUND	1066	Ø1200x62	2 pce	109
EchoSail® 12mm SQUARE	1067	1200x1200x62	2 pce	139

**ECHOSAIL® 12MM  
BUTTERFLY**



**ECHOSAIL® 12MM  
HEXAGON**



**ECHOSAIL® 12MM  
RECTANGLE**



**ECHOSAIL® 12MM  
ROUND**



**ECHOSAIL® 12MM  
SQUARE**

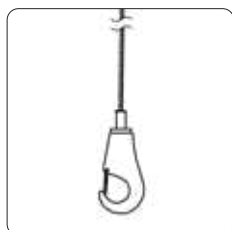

**SAFETY HOOK**

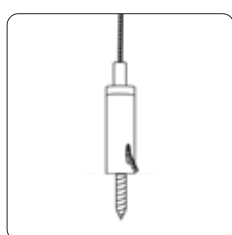

**DIRECTLY SCREWED**

**ECHOSAIL® 24MM  
SQUARE L**



**ECHOSAIL® 24MM  
STONE**

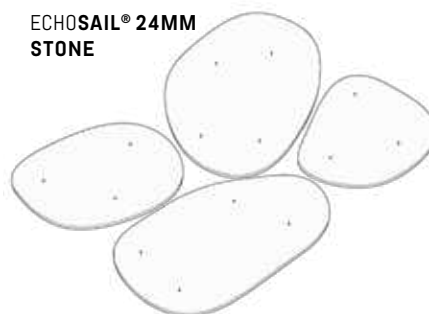

# ECHOSAIL® 24MM

Acoustic sails in various shapes and surface designs incl. suspension system up to 1500mm. The EchoSail® is suspended directly with screws up to a length of 1000mm. For all shapes over 1000mm long, the EchoSail® is suspended with a frame and safety hooks. The frame is white as standard and can be supplied in other colours to order.

Absorption coefficient:  $\alpha_w$  1.00, class A

Edge finish: 90°, corner radius 200mm

NAME	ARTICLE	W x H x D (in mm)	UNIT	PET-BOTTLES
EchoSail® 24mm BUTTERFLY M	1068	1091x811x74	4 pce	154
EchoSail® 24mm BUTTERFLY L	1069	1273x1708x74	2 pce	252
EchoSail® 24mm HEXAGON M	1070	1180x1078x74	2 pce	141
EchoSail® 24mm HEXAGON L	1071	1800x1645x74	1 pce	165
EchoSail® 24mm RECTANGLE M	1072	2400x1200x74	1 pce	199
EchoSail® 24mm RECTANGLE L	1073	2400x1800x74	1 pce	303
EchoSail® 24mm ROUND M	1074	Ø1200x61	2 pce	155
EchoSail® 24mm ROUND L	1075	Ø1800x74	1 pce	180
EchoSail® 24mm SQUARE M	1076	1200x1200x74	2 pce	197
EchoSail® 24mm SQUARE L	1077	1800x1800x74	1 pce	230
EchoSail® 24mm STONE	1078	954-1530x820-971x61	4 pce	245

**ECHOSAIL® 24MM  
BUTTERFLY M**



**ECHOSAIL® 24MM  
BUTTERFLY L**

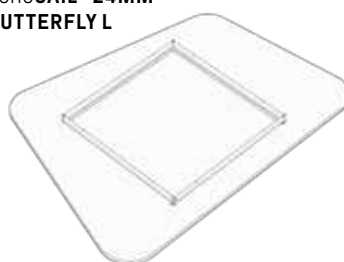

**ECHOSAIL® 24MM  
HEXAGON M**



**ECHOSAIL® 24MM  
HEXAGON L**

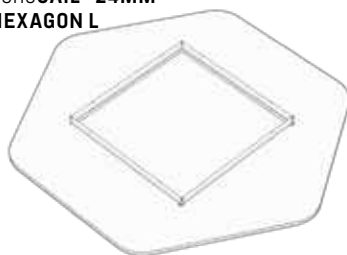

**ECHOSAIL® 24MM  
RECTANGLE M**



**ECHOSAIL® 24MM  
RECTANGLE L**



**ECHOSAIL® 24MM  
ROUND M**



**ECHOSAIL® 24MM  
ROUND L**

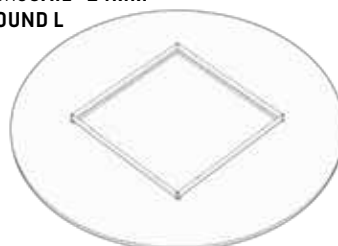

**ECHOSAIL® 24MM  
SQUARE M**





## ECHOBaffle®

EchoBaffles® suspended vertically from the ceiling combine efficient acoustic well-being and striking design in open ceilings. It is visibly different from conventional ceilings. The open ceiling concepts also ensure the integration of the building structures in terms of climate technology while optimising the room acoustics at the same time. The inlays are plugged together on site and hooked into the grid ceiling without tools. The very light grid inlays can be easily removed, allowing easy access for maintenance of the building services.

The high acoustic performance of EchoBaffles® effectively dampens sound and “audibly” upgrades rooms with high noise levels. As a customised solution with individual design, the acoustic ceiling becomes a special eye-catcher and lends the room a lot of dynamism.

EchoBaffle® allows ceilings ranging from understated simplicity to dramatic sculptural shapes. The creations of the ECHO**JAZZ** designers are only a starting point, we are happy to work out individual designs on customer request. Complete reusability after use guaranteed – zero waste!



COMPANY PROFILE

MATERIAL

CEILING

LIGHTING

WALLS

PARTITIONS

FURNITURE

ADDITIONAL ITEMS

CREATE

# ECHOBaffle® 12MM

Acoustic baffles consisting of baffle blades incl. substructure and suspension.

Absorption coefficient:  $\alpha_w$  0.45

When ordering custom designed EchoBaffle® ceilings additional specifications are needed. (Page 209)

You can always find the latest designs on our website: [www.echojazz.com/echobaffle](http://www.echojazz.com/echobaffle).

EchoBoard® 12mm colours are available depending on stock.

Individual EchoBaffle® solutions available on request!

NAME	ARTICLE	W x H x D (in mm)	UNIT	PET-BOTTLES
EchoBaffle® 12mm PLAIN M	1031	1390x1600x235	1 Pce	158
EchoBaffle® 12mm PLAIN L	1032	2780x1600x235	1 Pce	201
EchoBaffle® 12mm CORNER M	1029	1390x1600x240	1 Pce	120
EchoBaffle® 12mm CORNER L	1030	2780x1600x240	1 Pce	306
EchoBaffle® 12mm VOGUE M	1033	1390x1600x290	1 Pce	118
EchoBaffle® 12mm VOGUE L	1034	2780x1600x290	1 Pce	227
EchoBaffle® 12mm CUSTOM DESIGN	1079	According to design	1 Pce	

**ECHOBaffle® 12MM  
PLAIN M**

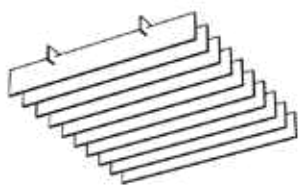

**ECHOBaffle® 12MM  
PLAIN L**

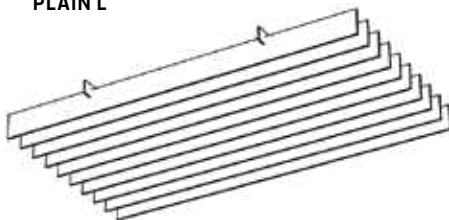

**ECHOBaffle® 12MM  
CORNER M**

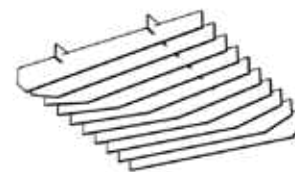

**ECHOBaffle® 12MM  
CORNER L**

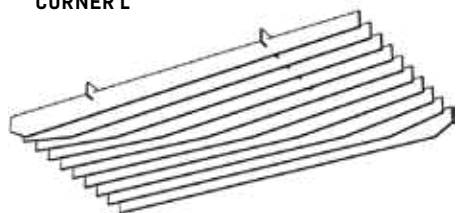

**ECHOBaffle® 12MM  
VOGUE M**

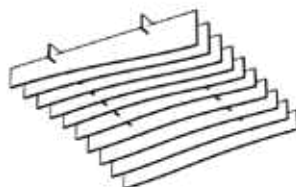

**ECHOBaffle® 12MM  
VOGUE L**

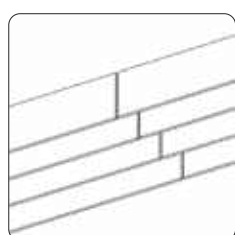
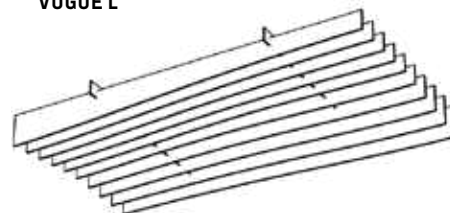

**CLOSED EDGE**

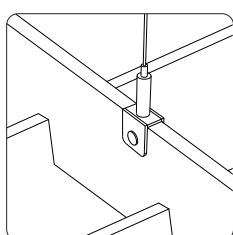

**DIRECT SUSPENSION**

# ECHOBAFFLE® 24MM

Acoustic baffles consisting of baffle blades incl. substructure and suspension.

Absorption coefficient:  $\alpha_w$  0.50

When ordering custom designed EchoBaffle® ceilings additional specifications are needed. (Page 209)

You can always find the latest designs on our website: [www.echojazz.com/echobaffle](http://www.echojazz.com/echobaffle).

Individual EchoBaffle® solutions available on request!

NAME	ARTICLE	W x H x D (in mm)	UNIT	PET-BOTTLES
EchoBaffle® 24mm PLAIN M	1037	1075x1600x235	1 Pce	147
EchoBaffle® 24mm PLAIN L	1038	2400x1600x235	1 Pce	307
EchoBaffle® 24mm CORNER M	1035	1075x1600x240	1 Pce	124
EchoBaffle® 24mm CORNER L	1036	2400x1600x240	1 Pce	240
EchoBaffle® 24mm VOGUE M	1039	1075x1600x290	1 Pce	124
EchoBaffle® 24mm VOGUE L	1040	2400x1600x290	1 Pce	250
EchoBaffle® 12mm CUSTOM DESIGN	1082	According to design	1 Pce	

**ECHOBAFFLE® 24MM  
PLAIN M**

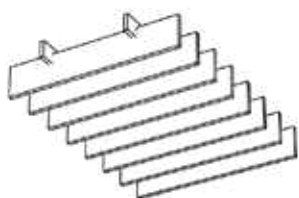

**ECHOBAFFLE® 24MM  
PLAIN L**

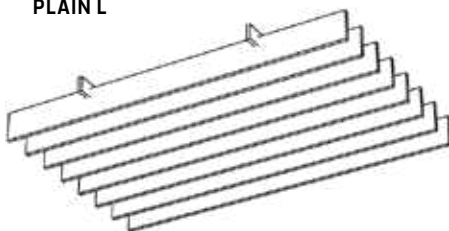

**ECHOBAFFLE® 24MM  
CORNER M**

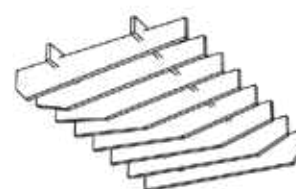

**ECHOBAFFLE® 24MM  
CORNER L**

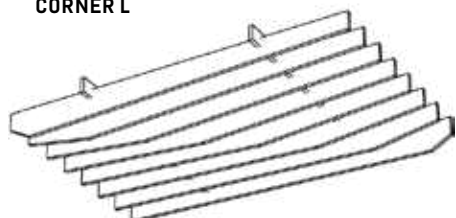

**ECHOBAFFLE® 24MM  
VOGUE M**

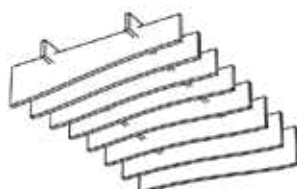

**ECHOBAFFLE® 24MM  
VOGUE L**

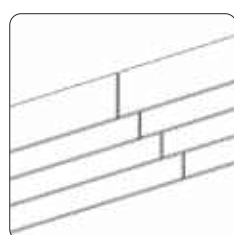
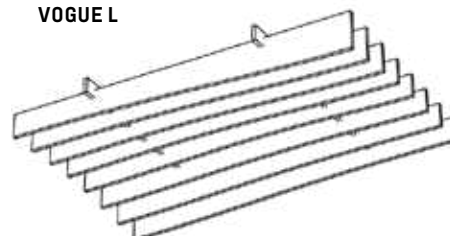

**CLOSED EDGE**

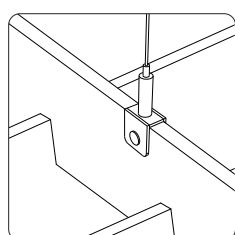

**DIRECT SUSPENSION**



## ECHOGRID®

EchoGrid® is a new inlay for grid ceilings. It's an innovative concept for grid ceilings that is visibly different from conventional ceilings. The high acoustic performance noticeably and audibly upgrades heavily frequented rooms. The inlays are plugged together on site and hooked into the grid ceiling without tools. The very light grid inlays can be easily removed, allowing easy access for maintenance of the building services. Complete reusability after use guaranteed - zero waste!

EchoGrid® allows ceilings ranging from understated simplicity to dramatic sculptural shapes. The creations of the **ECHOJAZZ** designers are only a starting point, we are happy to work out individual designs on customer request.

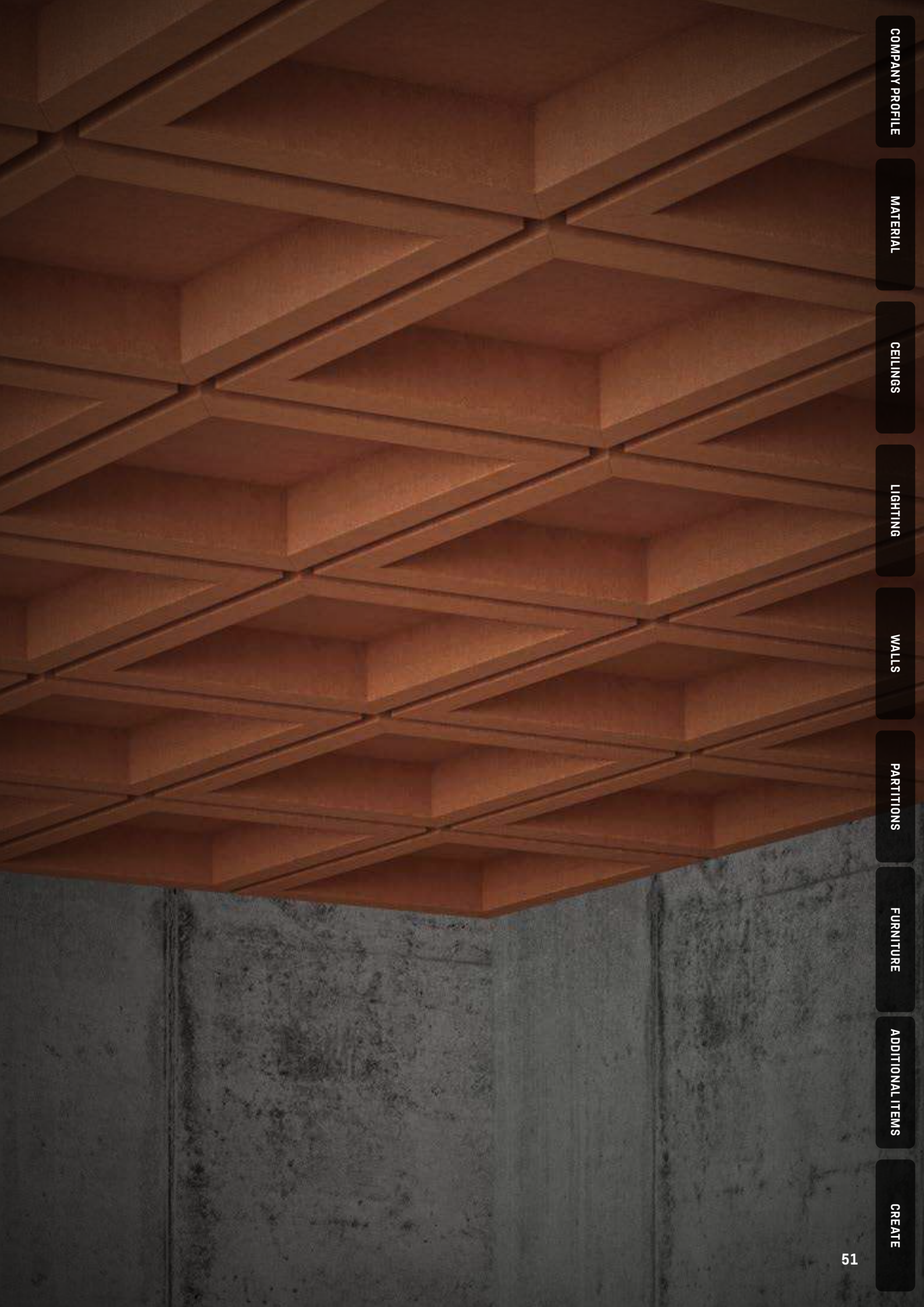

COMPANY PROFILE

MATERIAL

CEILING

LIGHTING

WALLS

PARTITIONS

FURNITURE

ADDITIONAL ITEMS

CREATE

# ECHOGRID® 12MM

High-performance acoustic inlay for ceiling grids with textile surface made of 100% PET.

Suitable for grid sizes 625x625mm & 1250x625mm with profile width 24mm

Minimum distance between ceiling and grid: 200mm

Individual EchoGrid® solutions on request!

\*This product is available with our carving designs. (Page 234)

\*\*This product is available with our perforations. (Page 238)

You can always find the latest designs on our website [www.echojazz.com/echogrid](http://www.echojazz.com/echogrid)



NAME	ARTICLE	W x H x D (in mm)	UNIT	PET-BOTTLES
EchoGrid® 12mm BLADES 1250 PREMIUM	1043	1250x600x130mm	2 Pce	115
EchoGrid® 12mm BLADES 1250 STANDARD	1044	1250x600x130mm	4 Pce	120
EchoGrid® 12mm BLADES 625 PREMIUM	1041	619x600x130mm	4 Pce	104
EchoGrid® 12mm BLADES 625 STANDARD	1042	619x600x130mm	8 Pce	116
EchoGrid® 12mm CROSSING 1250 PREMIUM	1047	1250x600x150mm	2 Pce	131
EchoGrid® 12mm CROSSING 1250 STANDARD	1048	1250x600x150mm	4 Pce	144
EchoGrid® 12mm CROSSING 625 PREMIUM	1045	619x600x120mm	4 Pce	108
EchoGrid® 12mm CROSSING 625 STANDARD	1046	619x600x120mm	8 Pce	121
EchoGrid® 12mm MATRIX 1250 PREMIUM	1051	1250x599x72mm	4 Pce	145
EchoGrid® 12mm MATRIX 1250 STANDARD	1052	1250x599x72mm	6 Pce	162
EchoGrid® 12mm MATRIX 625 PREMIUM	1049	619x599x72mm	8 Pce	144
EchoGrid® 12mm MATRIX 625 STANDARD	1050	619x599x72mm	11 Pce	147
EchoGrid® 12mm PLAIN 1250 PREMIUM	1055	1250x600x65mm	3 Pce	132
EchoGrid® 12mm PLAIN 1250 STANDARD	1056	1250x600x65mm	6 Pce	152
EchoGrid® 12mm PLAIN 625 PREMIUM	1053	619x600x65mm	6 Pce	129
EchoGrid® 12mm PLAIN 625 STANDARD	1054	619x600x65mm	12 Pce	149
EchoGrid® 12mm DUNE 625 PREMIUM	1759	619x600x127mm	4 Pce	104
EchoGrid® 12mm DUNE 625 STANDARD	1760	619x600x127mm	8 Pce	113
EchoGrid® 12mm DUNE 1250 PREMIUM	1761	1250x600x129mm	2 Pce	107
EchoGrid® 12mm DUNE 1250 STANDARD	1762	1250x600x128mm	4 Pce	116
EchoGrid® 12mm SLOPES 625 PREMIUM	1763	619x600x110mm	4 Pce	104
EchoGrid® 12mm SLOPES 625 STANDARD	1764	619x600x110mm	8 Pce	114
EchoGrid® 12mm SLOPES 1250 PREMIUM	1765	1250x600x143mm	2 Pce	129
EchoGrid® 12mm SLOPES 1250 STANDARD	1766	1250x600x143mm	4 Pce	138
EchoGrid® 12mm CASSETTE 625 PREMIUM	1767	619x595x93mm	4 Pce	185
EchoGrid® 12mm CASSETTE 625 STANDARD	1768	619x595x50mm	6 Pce	221
EchoGrid® 12mm SPINE 625	1769	619x599x39mm	8 Pce	154
EchoGrid® 12mm TILE 1250	1058	1244x610x12mm	4 Pce	152
EchoGrid® 12mm TILE 625	1057	619x610x12mm	8 Pce	151
*EchoGrid® 12mm CARVING 1250	1771	1244x610x12mm	4 Pce	152
*EchoGrid® 12mm CARVING 625	1770	619x610x12mm	8 Pce	151
**EchoGrid® 12mm PERFORATED 1250	1773	1244x610x12mm	4 Pce	114
**EchoGrid® 12mm PERFORATED 625	1772	619x610x12mm	8 Pce	113

ECHOGRID® 12MM  
BLADES 625 P

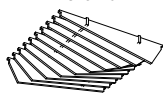

ECHOGRID® 12MM  
BLADES 1250 P

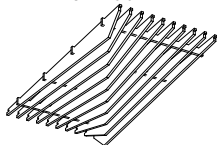

ECHOGRID® 12MM  
BLADES 625 S



ECHOGRID® 12MM  
BLADES 1250 S

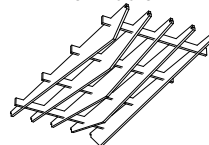

ECHOGRID® 12MM  
CROSSING 625 P

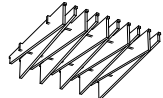

ECHOGRID® 12MM  
CROSSING 1250 P

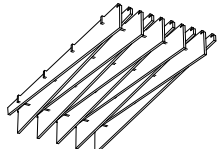

ECHOGRID® 12MM  
CROSSING 625 S

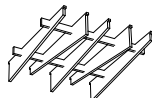

ECHOGRID® 12MM  
CROSSING 1250 S

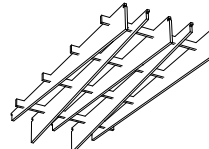

ECHOGRID® 12MM  
MATRIX 625 P

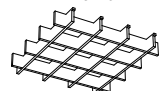

ECHOGRID® 12MM  
MATRIX 1250 P

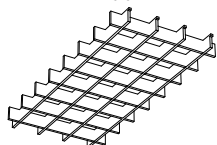

ECHOGRID® 12MM  
MATRIX 625 S

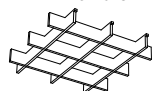

ECHOGRID® 12MM  
MATRIX 1250 S

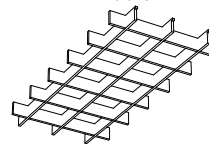

ECHOGRID® 12MM  
PLAIN 625 P

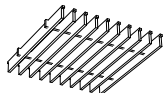

ECHOGRID® 12MM  
PLAIN 1250 P

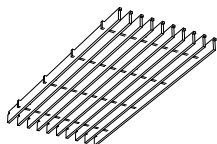

ECHOGRID® 12MM  
PLAIN 625 S

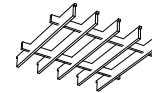

ECHOGRID® 12MM  
PLAIN 1250 S

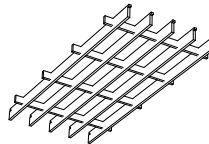

ECHOGRID® 12MM  
DUNE 625 P



ECHOGRID® 12MM  
DUNE 1250 P

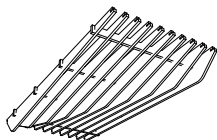

ECHOGRID® 12MM  
DUNE 625 S

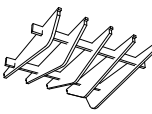

ECHOGRID® 12MM  
DUNE 1250 S

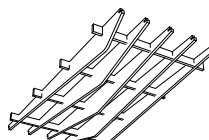

ECHOGRID® 12MM  
SLOPES 625 P



ECHOGRID® 12MM  
SLOPES 1250 P

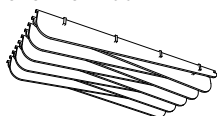

ECHOGRID® 12MM  
SLOPES 625 S

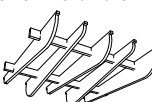

ECHOGRID® 12MM  
SLOPES 1250 S

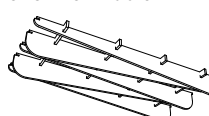

ECHOGRID® 12MM  
CASSETTE 625 P

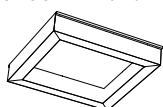

ECHOGRID® 12MM  
CASSETTE 625 S

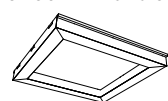

ECHOGRID® 12MM  
SPINE 625



ECHOGRID® 12MM  
TILE 625

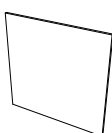

ECHOGRID® 12MM  
TILE 1250

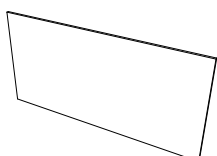

\*ECHOGRID® 12MM  
CARVING 625

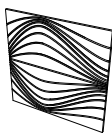

\*ECHOGRID® 12MM  
CARVING 1250

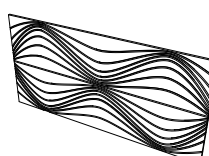

\*\*ECHOGRID® 12MM  
PERFORATED 625

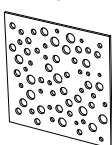

\*\*ECHOGRID® 12MM  
PERFORATED 1250

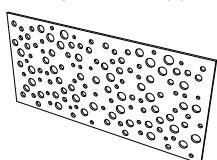

# ECHOGRID® 24MM

High-performance acoustic inlay for ceiling grids with textile surface made of 100% PET.

Suitable for grid sizes 625x625mm & 1250x625mm with profile width 24mm

Minimum distance between ceiling and grid: 200mm

Individual EchoGrid® solutions on request!

\*This product is available with our carving designs. (Page 234)

\*\*This product is available with our perforations. (Page 238)

You can always find the latest designs on our website [www.echojazz.com/echogrid](http://www.echojazz.com/echogrid)



NAME	ARTICLE	W x H x D (in mm)	UNIT	PET-BOTTLES
EchoGrid® 24mm TILE 1250	1060	1244x610x24mm	4 Pce	228
EchoGrid® 24mm TILE 625	1059	619x610x24mm	9 Pce	255
*EchoGrid® 24mm CARVING 1250	1776	1244x610x24mm	4 Pce	228
*EchoGrid® 24mm CARVING 625	1775	619x610x24mm	9 Pce	255
**EchoGrid® 24mm PERFORATED 1250	1778	1244x610x24mm	4 Pce	171
**EchoGrid® 24mm PERFORATED 625	1777	619x610x24mm	9 Pce	191

**ECHOGRID® 24MM  
TILE 625**

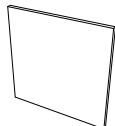

**ECHOGRID® 24MM  
TILE 1250**

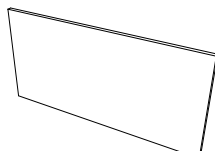

**\*ECHOGRID® 24MM  
CARVING 625**

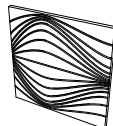

**\*ECHOGRID® 24MM  
CARVING 1250**

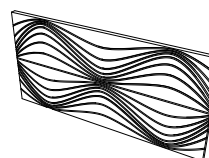

**\*\*ECHOGRID® 24MM  
PERFORATED 625**

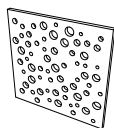

**\*\*ECHOGRID® 24MM  
PERFORATED 1250**

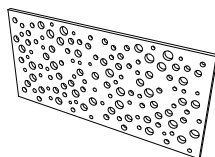



COMPANY PROFILE

MATERIAL

CEILING

LIGHTING

WALLS

PARTITIONS

FURNITURE

ADDITIONAL ITEMS

CREATE



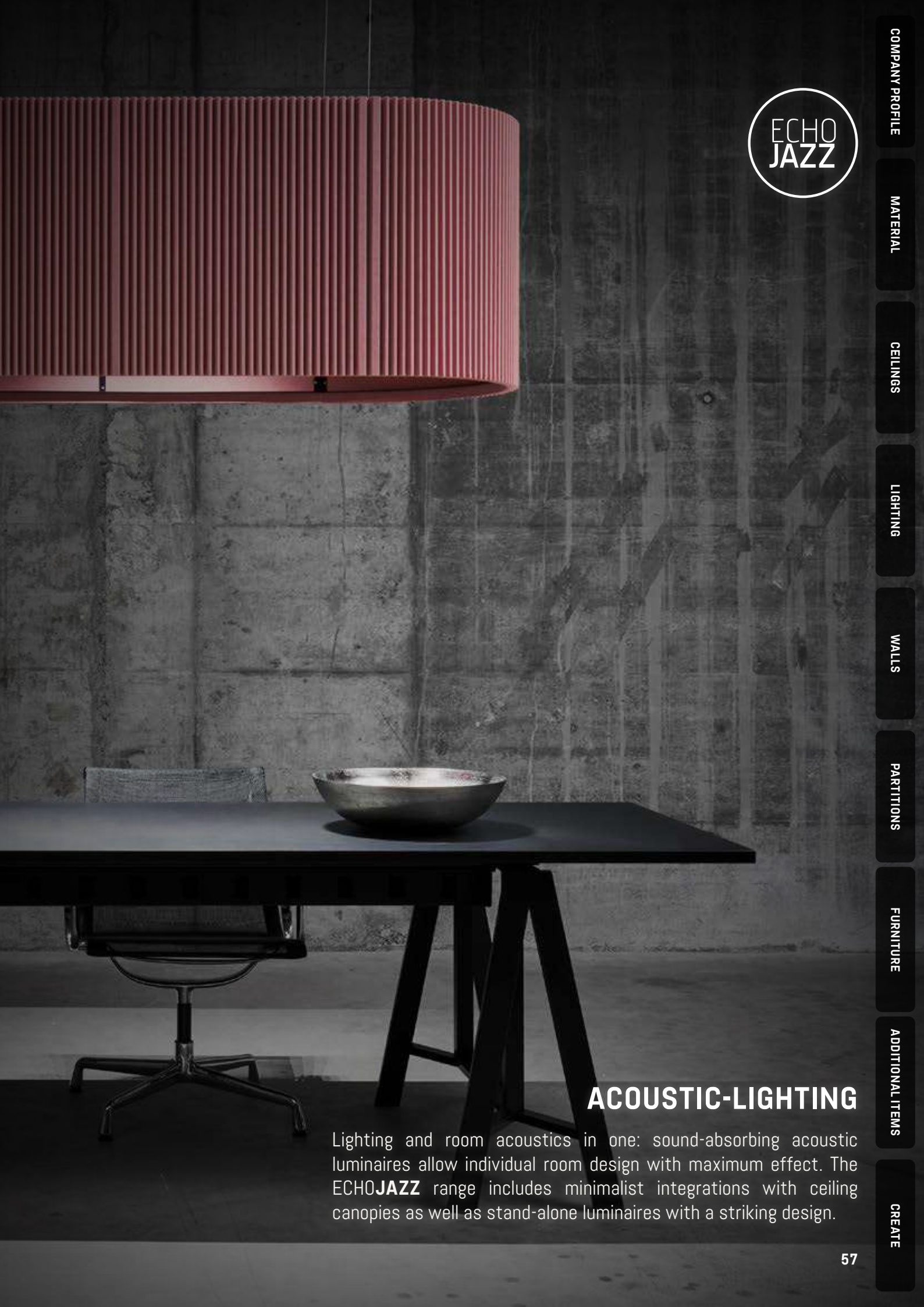

## ACOUSTIC-LIGHTING

Lighting and room acoustics in one: sound-absorbing acoustic luminaires allow individual room design with maximum effect. The **ECHOJAZZ** range includes minimalist integrations with ceiling canopies as well as stand-alone luminaires with a striking design.

The image shows a modern office environment. In the foreground, a white desk with a black acoustic sail is visible. The acoustic sail has a complex, geometric pattern of interconnected lines. A potted plant with large green leaves sits on the floor next to the desk. The background is a textured concrete wall with visible vertical lines and small circular indentations. The lighting is soft and focused on the desk area.

## ECHOLED® SITAS

For maximum comfort at the workplace, EchoLED® SITAS has a luminous field integrated into a high-performance acoustic absorber. The recessed light with microprismatic cover sits in the centre of the acoustic sail. It is produced tailor-made by ECHO**JAZZ** with a large range of shapes and sizes available in our 21 colours.

Thanks to the many options, the acoustic light can be optimally integrated into a design concept. The combination of light quality, functionality and acoustic well-being ensures optimum ergonomics for employees.



COMPANY PROFILE

MATERIAL

CEILING

LIGHTING

WALLS

PARTITIONS

FURNITURE

ADDITIONAL ITEMS

CREATE

# ECHOLED® 24MM SITAS

Acoustic sail with fully integrated direct lighting with DALI dimming mode incl. substructure and suspension. The EchoLED® SITAS luminaire is suspended using a frame and safety hooks. The frame is white as standard and can be supplied in other colours to order. Supplied without plug.

Absorption coefficient:  $\alpha_w$  1.00, class A

Edge processing: 90°, corner radii 200mm

Available on request in ON/OFF only, without DALI dimming mode.

Light source in 3000K available on request. The standard illuminant is supplied with a light colour of 4000K. (Tech. info: [Page 211](#))

NAME	ARTICLE	W x H x D (in mm)	UNIT	PET-BOTTLES
EchoLED® 24mm SITAS RECTANGLE M	1132	1800x1180x84	1 Pce	151
EchoLED® 24mm SITAS RECTANGLE M (*Set of 2)	1133	1800x1180x84	Set of 2*	303
EchoLED® 24mm SITAS RECTANGLE L	1116	2380x1800x84	1 Pce	303
EchoLED® 24mm SITAS ROUND M	1134	Ø1180x84	1 Pce	82
EchoLED® 24mm SITAS ROUND M (*Set of 2)	1135	Ø1180x84	Set of 2*	164
EchoLED® 24mm SITAS ROUND L	1136	Ø1800x84	1 Pce	190
EchoLED® 24mm SITAS SQUARE M	1137	1180x1180x84	1 Pce	104
EchoLED® 24mm SITAS SQUARE M (*Set of 2)	1138	1180x1180x84	Set of 2*	208
EchoLED® 24mm SITAS SQUARE L	1139	1800x1800x84	1 Pce	243

\*Only one colour possible per set

ECHOLED® 24MM SITAS  
RECTANGLE M

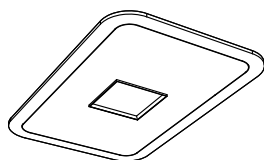

ECHOLED® 24MM SITAS  
ROUND M

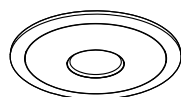

ECHOLED® 24MM SITAS  
SQUARE M

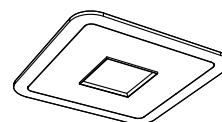

ECHOLED® 24MM SITAS  
RECTANGLE L

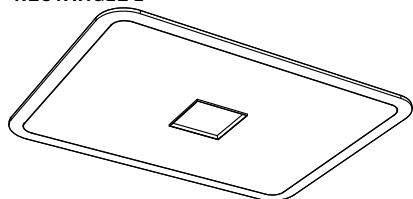

ECHOLED® 24MM SITAS  
ROUND L

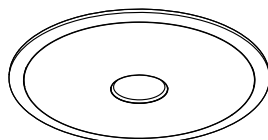

ECHOLED® 24MM SITAS  
SQUARE L

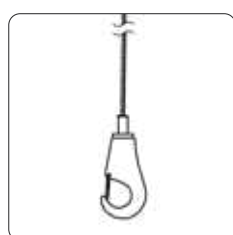
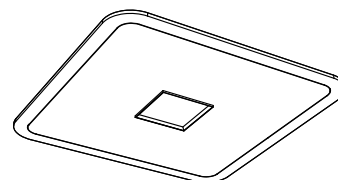

SAFETY HOOK



COMPANY PROFILE

MATERIAL

CEILING

LIGHTING

WALLS

PARTITIONS

FURNITURE

ADDITIONAL ITEMS

CREATE



## ECHOLED® NOVEM

The EchoLED® NOVEM integrates itself almost invisibly into the high performance acoustic sails. The module offers an extraordinary light quality with its 9 spots and indirect lighting towards the ceiling. DALI dimming mode is included as standard.

The acoustic light offers an unimposing, minimalist look and endless possibilities in the design of the room. Spot on!



COMPANY PROFILE

MATERIAL

CEILING

LIGHTING

WALLS

PARTITIONS

FURNITURE

ADDITIONAL ITEMS

CREATE

# ECHOLED® 24MM NOVEM

Acoustic sail with fully integrated direct and indirect lighting with DALI dimming mode incl. substructure and suspension. The EchoLED® NOVEM luminaire is suspended using a frame and safety hooks. The frame is white as standard and can be supplied in other colours to order. Supplied without plug.

Absorption coefficient:  $\alpha_w$  1.00, class A

Edge finish: 90°, corner radius 200mm

Available on request in ON/OFF only, without DALI dimming mode.

Light source in 3000K available on request. The standard illuminant is supplied with a light colour of 4000K. (Tech. info: [Page 211](#))

Available on request without indirect ceiling lighting.

NAME	ARTICLE	W x H x D (in mm)	UNIT	PET-BOTTLES
EchoLED® 24mm NOVEM RECTANGLE M	1123	1800x1180x72	1 Pce	151
EchoLED® 24mm NOVEM RECTANGLE M (*Set of 2)	1123	1800x1180x72	Set of 2*	303
EchoLED® 24mm NOVEM RECTANGLE L	1125	2380x1800x72	1 Pce	303
EchoLED® 24mm NOVEM RECTANGLE L2	1475	2380x1800x72	1 Pce	303
EchoLED® 24mm NOVEM ROUND M	1126	Ø1180x72	1 Pce	82
EchoLED® 24mm NOVEM ROUND M (*Set of 2)	1127	Ø1180x72	Set of 2*	164
EchoLED® 24mm NOVEM ROUND L	1128	Ø1800x72	1 Pce	190
EchoLED® 24mm NOVEM SQUARE M	1129	1180x1180x72	1 Pce	104
EchoLED® 24mm NOVEM SQUARE M (*Set of 2)	1130	1180x1180x72	Set of 2*	208
EchoLED® 24mm NOVEM SQUARE L	1131	1800x1800x72	1 Pce	243

\*Only one colour possible per set

ECHOLED® 24MM NOVEM  
RECTANGLE M

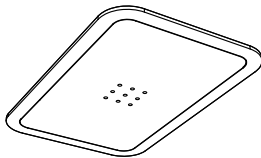

ECHOLED® 24MM NOVEM  
RECTANGLE L

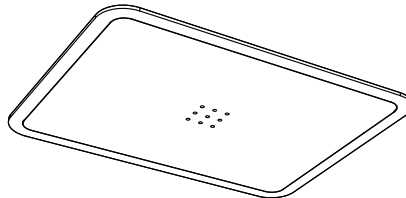

ECHOLED® 24MM NOVEM  
RECTANGLE L2

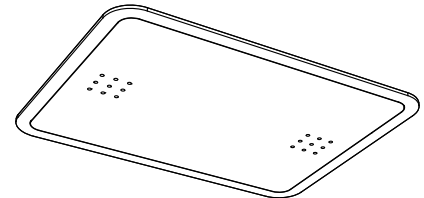

ECHOLED® 24MM NOVEM  
ROUND M

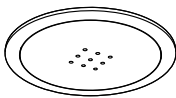

ECHOLED® 24MM NOVEM  
ROUND L

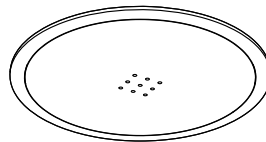

ECHOLED® 24MM NOVEM  
SQUARE M

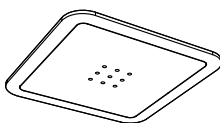

ECHOLED® 24MM NOVEM  
SQUARE L

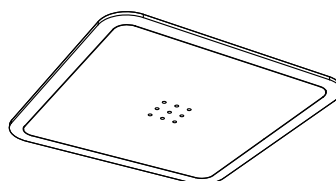

SAFETY HOOK

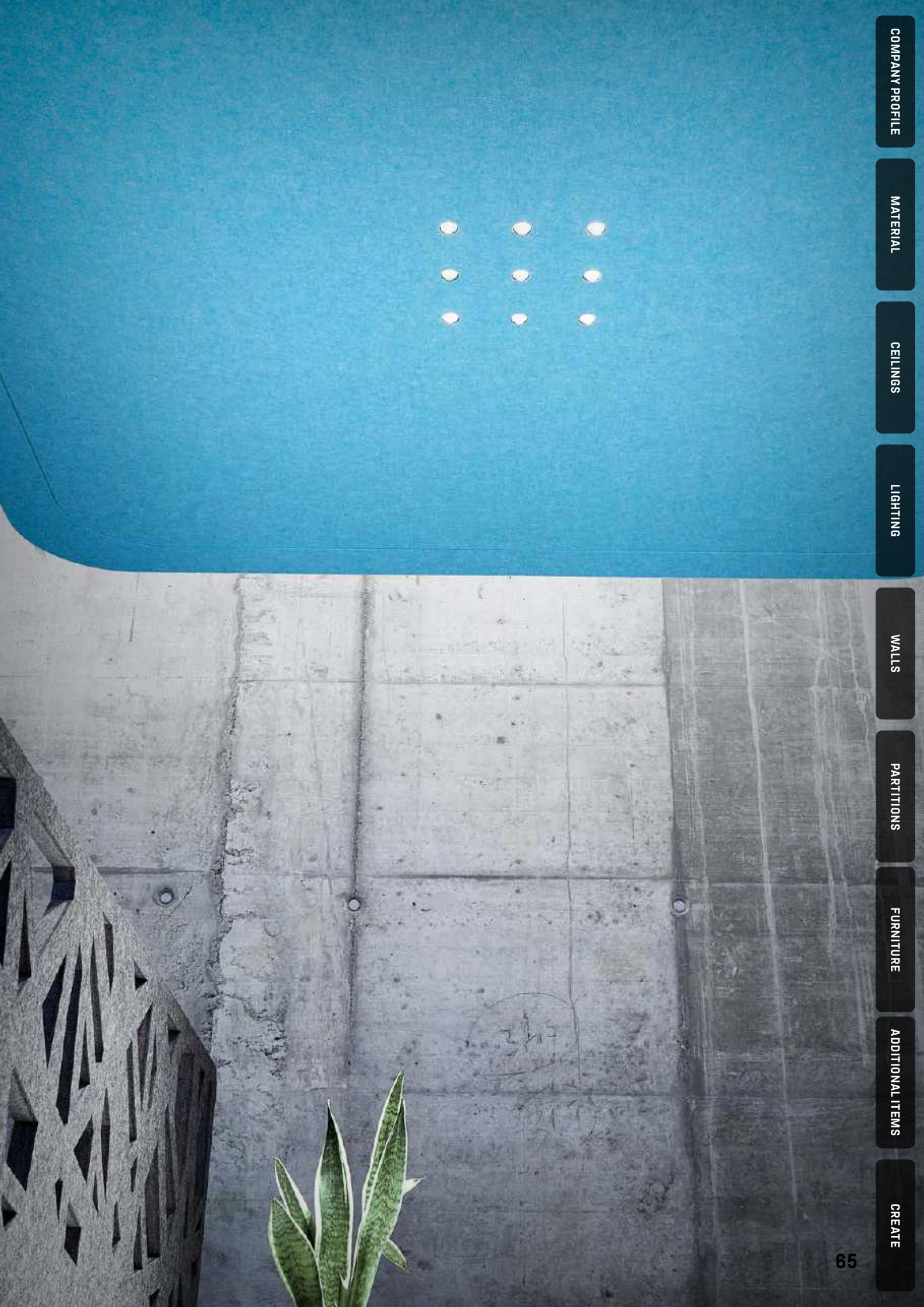

COMPANY PROFILE

MATERIAL

CEILING

LIGHTING

WALLS

PARTITIONS

FURNITURE

ADDITIONAL ITEMS

CREATE



## ECHOLED® EQ4

The elegant EchoLED® EQ4 task luminaire integrates almost invisibly into the high-performance acoustic ceiling, providing exceptional quality of light. The module offers all the possibilities of digital lighting control and is dimmable with DALI drivers as standard. The acoustic luminaire is supplied ready to plug in and can be easily connected or replaced.

EchoLED® EQ4 combines expertise from the fields of light and acoustics. ECHOJAZZ acoustics in interaction with Bartenbach lighting solutions.

**Bartenbach** 

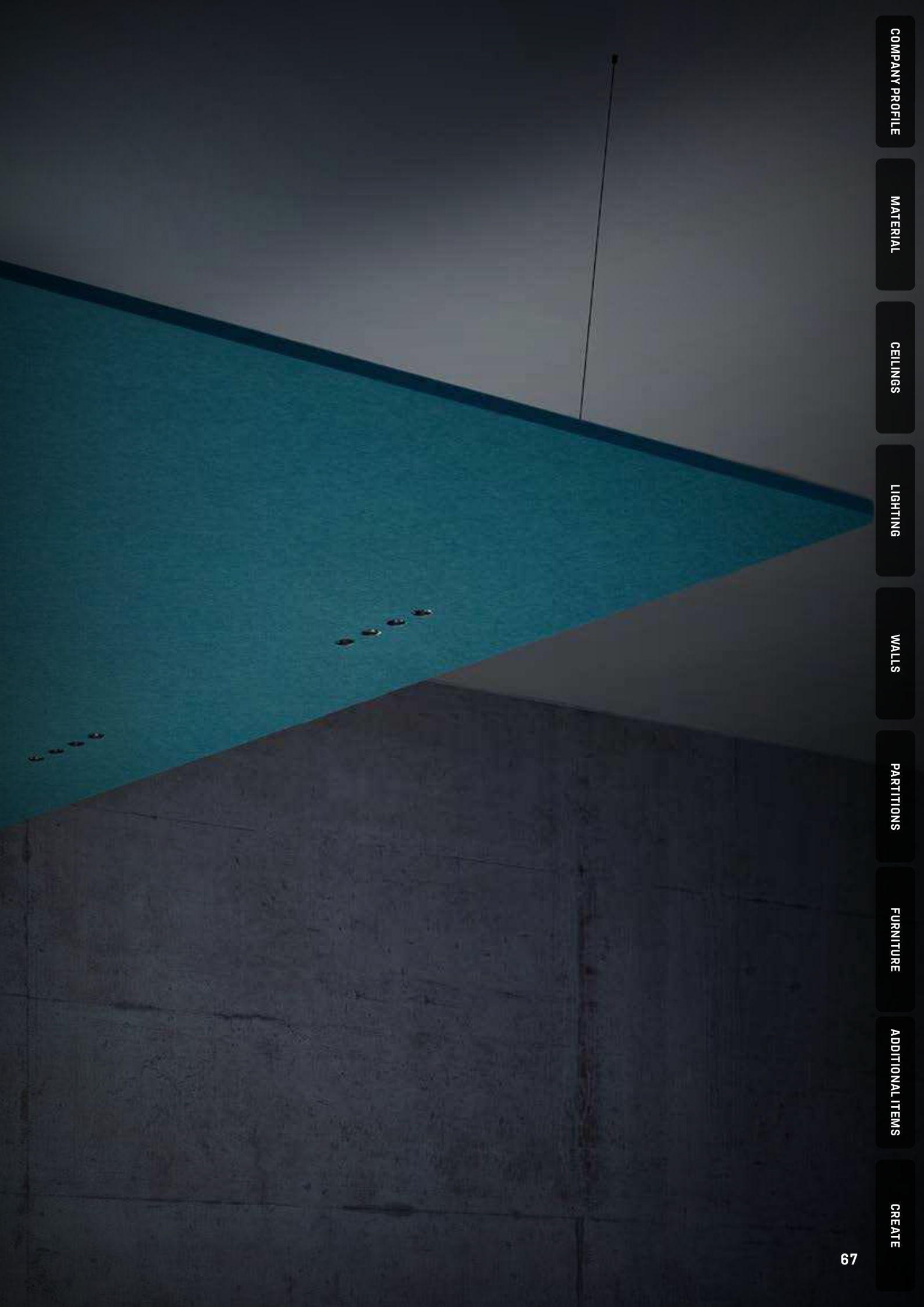

COMPANY PROFILE

MATERIAL

CEILING

LIGHTING

WALLS

PARTITIONS

FURNITURE

ADDITIONAL ITEMS

CREATE

# ECHOLED® 24MM EQ4

Acoustic sail with fully integrated lighting with DALI dimming mode incl. substructure and suspension. The EchoLED® EQ4 luminaire is suspended with frame and safety hook. The frame is white as standard and can be supplied in other colours to order. Supplied without plug.

Absorption coefficient: aw 1.00, class A

Edge finish: 90°, corner radius 40mm

Available with ON/OFF control on request.

Please specify the type of EchoLED® EQ4 PIN light module when ordering. (Page 213)

NAME	ARTICLE	W x H x D (in mm)	UNIT	PET-BOTTLES
EchoLED® 24mm EQ4 SINGLE M	1105	1180x1180x74	1 pce	99
EchoLED® 24mm EQ4 SINGLE L	1106	1800x1800x74	1 pce	230
EchoLED® 24mm EQ4 DOUBLE M	1107	1800x1800x74	1 pce	230
EchoLED® 24mm EQ4 DOUBLE L	1108	2380x1800x74	1 pce	303
EchoLED® 24mm EQ4 QUAD L	1109	2380x1800x74	1 pce	303

**ECHOLED® 24MM EQ4  
SINGLE M**



**ECHOLED® 24MM EQ4  
SINGLE L**



**ECHOLED® 24MM EQ4  
DOUBLE M**



**ECHOLED® 24MM EQ4  
DOUBLE L**

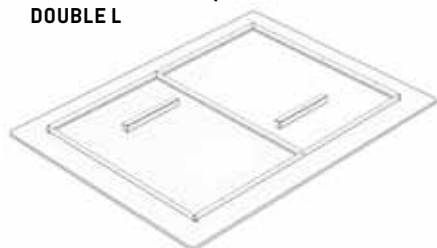

**ECHOLED® 24MM EQ4  
QUAD L**

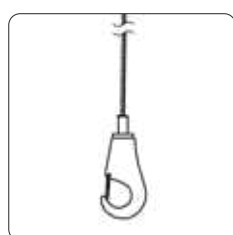
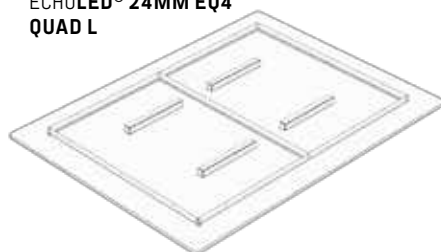

**SAFETY HOOK**

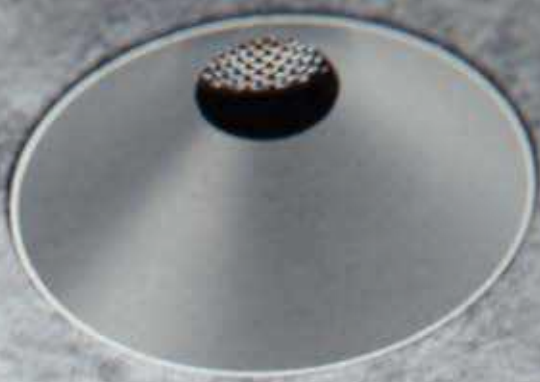

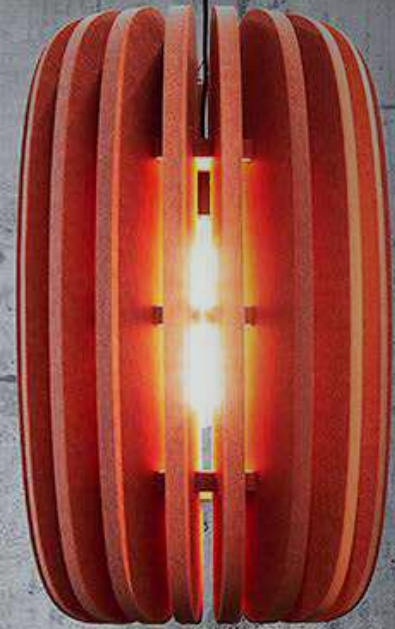

## ECHOAMBIENT® COCOON

The EchoAmbient® COCOON lifestyle ceiling lights give every room a unique ambience. Not only acoustically, but above all through beautiful light and shadow effects. The fan-like slats of the COCOON model give the luminaire a futuristic shape. Almost two square metres of the class A acoustic absorber ensure very efficient sound absorption.

The EchoAmbient® enables interior designers to improve acoustics at the same time as they are creating the lighting concept. The E27 socket offers full flexibility in the choice of light source. The lamp with its cocoon-shaped design is available in 21 expressive colours.



COMPANY PROFILE

MATERIAL

CEILING

LIGHTING

WALLS

PARTITIONS

FURNITURE

ADDITIONAL ITEMS

CREATE

# ECHOAMBIENT® 24MM COCOON

Acoustic pendant luminaire incl. substructure and suspension. Supplied without plug.

Absorption coefficient:  $\alpha_w$  1.00, class A

NAME	ARTICLE	ØxH (in mm)	UNIT	PET-BOTTLES
EchoAmbient® 24mm COCOON M	1084	470x750mm	1 pce	132

## ECHOAMBIENT® 24MM COCOON M

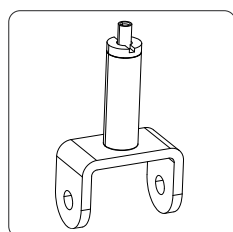
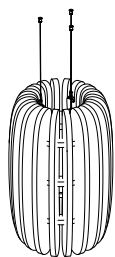

SUSPENSION SET

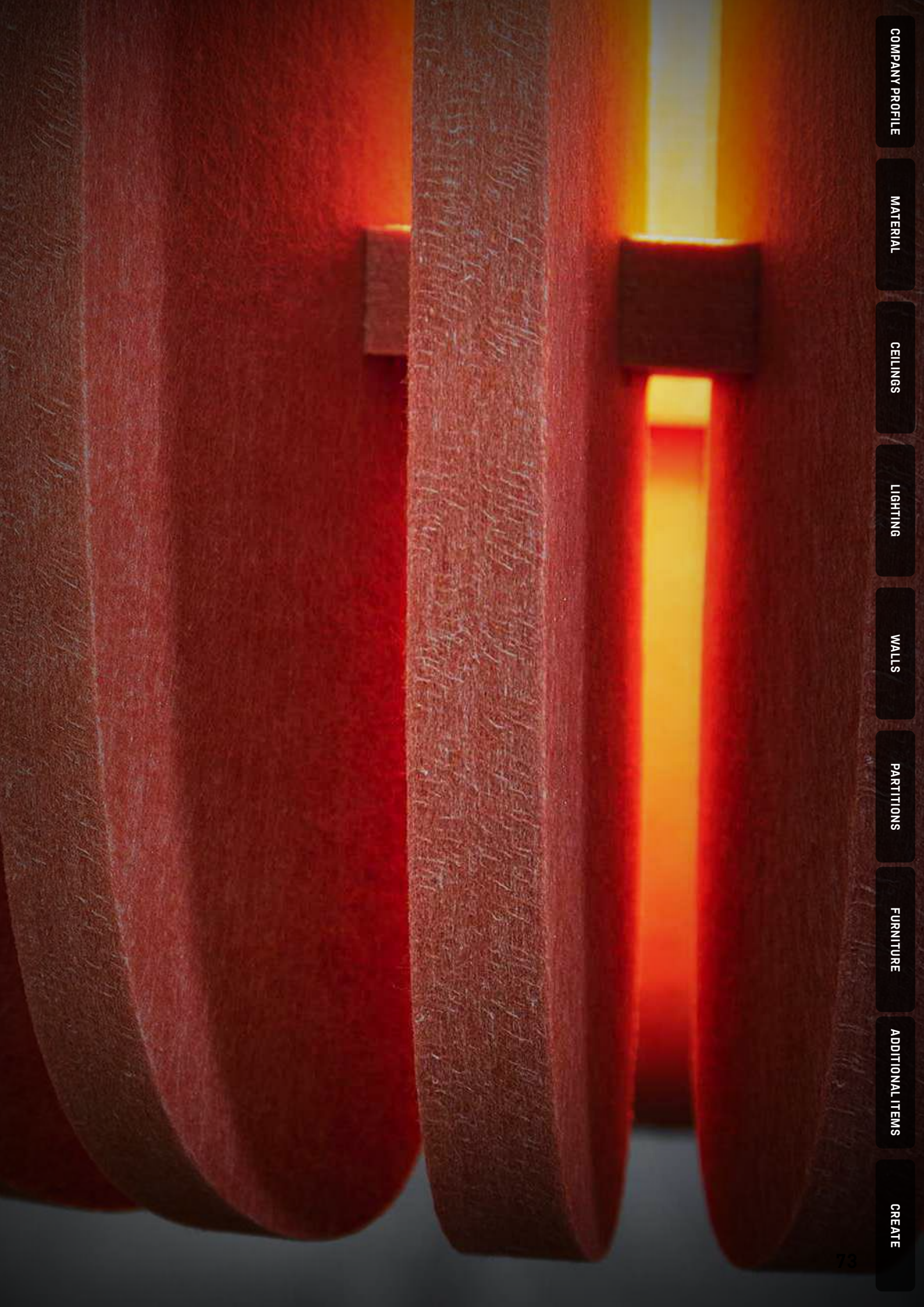

COMPANY PROFILE

MATERIAL

CEILING

LIGHTING

WALLS

PARTITIONS

FURNITURE

ADDITIONAL ITEMS

CREATE



## ECHOAMBIENT® CONE

The EchoAmbient® CONE lifestyle ceiling lights give every room a unique ambience. Not only acoustically, but above all through beautiful light and shadow effects. Behind the new design of the lampshades is the new development from ECHOJAZZ - the Stretch-Cut. This special cutting pattern not only creates the perforations, but also transforms our EchoBoard® into a stretchable acoustic material.

The E27 socket allows for maximum compatibility in bulb selection. The lamps shown here have a conical shape and are currently available in 3 sizes and 21 expressive colours. In combination with different frame elements, a variety of other shapes and sizes can also be designed. EchoAmbient® lamps allow planners and architects to give free rein to their creativity when it comes to acoustic lighting design. Challenge us!





COMPANY PROFILE

MATERIAL

CEILING

LIGHTING

WALLS

PARTITIONS

FURNITURE

ADDITIONAL ITEMS

CREATE

# ECHOAMBIENT® 24MM CONE

Acoustic pendant luminaire incl. substructure and suspension. Supplied without plug.

Absorption coefficient:  $\alpha_w$  1.00, class A

NAME	ARTICLE	ØxH (in mm)	UNIT	PET-BOTTLES
EchoAmbient® 24mm CONE XS	1085	422x310	1 pce	18
EchoAmbient® 24mm CONE S	1086	622x385	1 pce	39
EchoAmbient® 24mm CONE M	1087	822x534	1 pce	72

ECHOAMBIENT® 24MM  
CONE XS

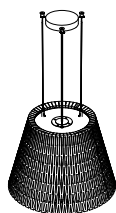

ECHOAMBIENT® 24MM  
CONE S

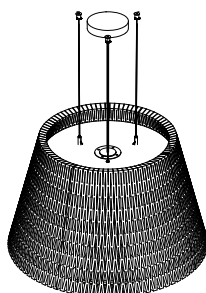

ECHOAMBIENT® 24MM  
CONE M

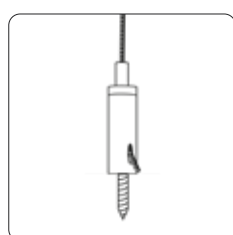
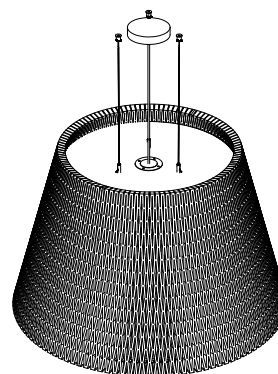

DIRECT SUSPENSION



COMPANY PROFILE

MATERIAL

CEILING

LIGHTING

WALLS

PARTITIONS

FURNITURE

ADDITIONAL ITEMS

CREATE



## ECHOLED® CONE

The EchoLED® CONE acoustic pendant light is ideal for open spaces with decorative requirements. The classic cone-shaped lampshade made of EchoBoard® effectively dampens sound. The quality spotlight with black reflector achieves a brightness of minimum 1680 Lumens, with a power consumption of an energy-efficient 20 watt.

EchoLED® CONE is available in five sizes, the lampshade made of PET acoustic material contains up to 360 recycled PET bottles. The ceiling lamp is particularly appealing thanks to the different material thicknesses, the 21 expressive colours and varying designs.



COMPANY PROFILE

MATERIAL

CEILING

LIGHTING

WALLS

PARTITIONS

FURNITURE

ADDITIONAL ITEMS

CREATE

# ECHOLED® 12MM CONE

Acoustic pendant luminaire incl. substructure and suspension. Supplied without plug.

Absorption coefficient:  $\alpha_w$  0.90, class A

NAME	ARTICLE	W x H x D (in mm)	UNIT	PET-BOTTLES
EchoLED 12mm CONE XS VERTIGO	1088	400x273x400	1 Pce	16
EchoLED 12mm CONE XS WAVY	1089	400x273x400	1 Pce	16
EchoLED 12mm CONE S VERTIGO	1090	600x403x600	1 Pce	37
EchoLED 12mm CONE S WAVY	1091	600x403x600	1 Pce	37
EchoLED 12mm CONE M VERTIGO	1092	800x533x800	1 Pce	66
EchoLED 12mm CONE M WAVY	1093	800x533x800	1 Pce	66
EchoLED 12mm CONE L VERTIGO	1094	1200x653x1200	1 Pce	136
EchoLED 12mm CONE L WAVY	1095	1200x653x1200	1 Pce	136
EchoLED 12mm CONE XL VERTIGO	1096	1600x853x1600	1 Pce	241
EchoLED 12mm CONE XL WAVY	1097	1600x853x1600	1 Pce	241

ECHOLED® 12MM CONE XS VERTIGO

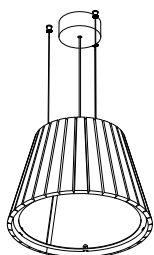

ECHOLED® 12MM CONE XS WAVY

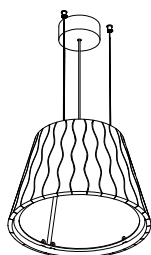

ECHOLED® 12MM CONE S VERTIGO

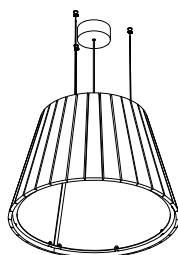

ECHOLED® 12MM CONE S WAVY

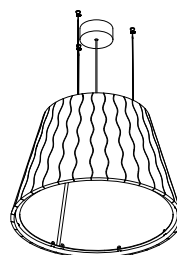

ECHOLED® 12MM CONE M VERTIGO

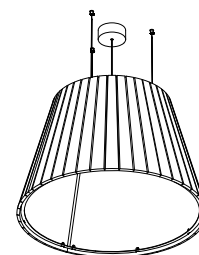

ECHOLED® 12MM CONE M WAVY

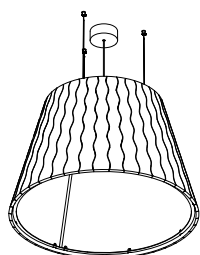

ECHOLED® 12MM CONE L VERTIGO

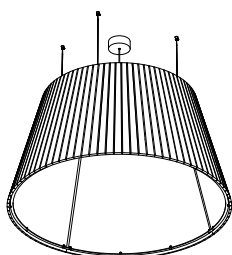

ECHOLED® 12MM CONE L WAVY

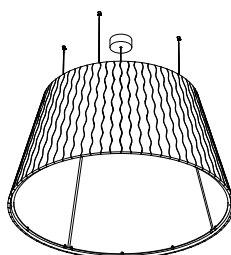

ECHOLED® 12MM CONE XL VERTIGO

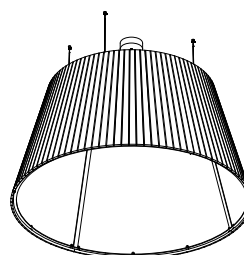

ECHOLED® 12MM CONE XL WAVY

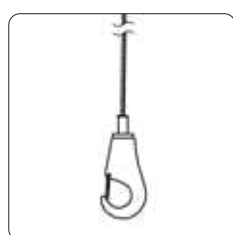
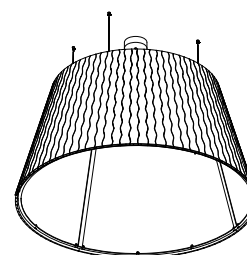

SAFETY HOOK

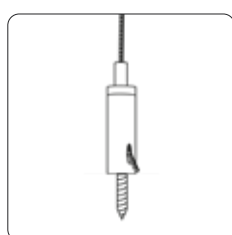

DIRECT SUSPENSION

# ECHOLED® 24MM CONE

Acoustic pendant luminaire incl. substructure and suspension. Supplied without plug.

Absorption coefficient: *aw* 1.00, class A

NAME	ARTICLE	W x H x D (in mm)	UNIT	PET-BOTTLES
EchoLED 24mm CONE XS WAVY	1100	424x276x424	1 Pce	24
EchoLED 24mm CONE S WAVY	1101	624x406x624	1 Pce	55
EchoLED 24mm CONE M WAVY	1102	824x536x824	1 Pce	99
EchoLED 24mm CONE L WAVY	1103	1224x656x1224	1 Pce	204
EchoLED 24mm CONE XL WAVY	1104	1624x856x1624	1 Pce	361

ECHOLED® 24MM CONE  
XS WAVY

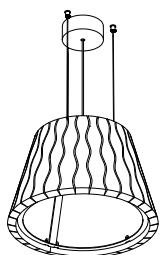

ECHOLED® 24MM CONE  
S WAVY

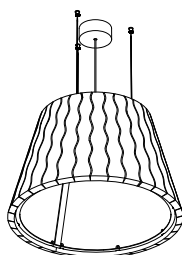

ECHOLED® 24MM CONE  
M WAVY

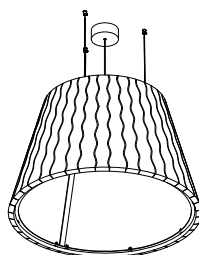

ECHOLED® 24MM CONE  
L WAVY

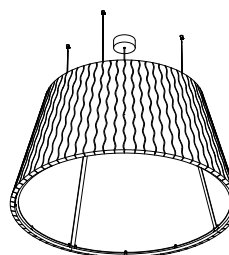

ECHOLED® 24MM CONE  
XL WAVY

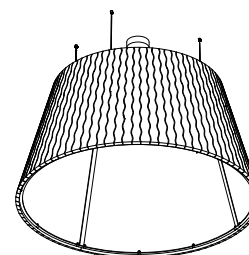

SAFETY HOOK

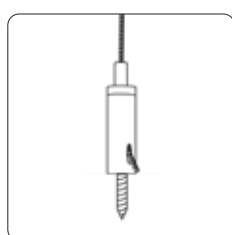

DIRECT SUSPENSION



## ECHOLED® UMBRA

The expressive acoustic luminaire is created for high rooms. It is available in two sizes and is ideal for strong acoustic absorption above workstations or conference tables. The EQ4 lighting module from Bartenbach offers all the possibilities of digital lighting control. The ideal distance from the table tops to the EchoLED® UMBRA should not be less than 170cm.

EchoLED® UMBRA combines expertise from the fields of light and acoustics. ECHOJAZZ acoustics in interaction with Bartenbach lighting solutions.

**Bartenbach** 



COMPANY PROFILE

MATERIAL

CEILING

LIGHTING

WALLS

PARTITIONS

FURNITURE

ADDITIONAL ITEMS

CREATE



# ECHOLED® 24MM UMBRA

Acoustic luminaire with DALI dimming mode incl. substructure and suspension. Supplied without plug.

Absorption coefficient:  $\alpha_w$  1.00, class A.

ON/OFF control available on request

On request, the UMBRA L is available in overlengths

When ordering, please specify the type of EchoLED® EQ4 PIN light module. ([Page 213](#))

NAME	ARTICLE	W x H x D (in mm)	UNIT	PET-BOTTLES
EchoLED® 24mm UMBRA M	1117	782x590x782	1 pce	117
EchoLED® 24mm UMBRA L	1118	2362x590x782	1 pce	300

ECHOLED® 24MM  
UMBRA M



ECHOLED® 24MM  
UMBRA L

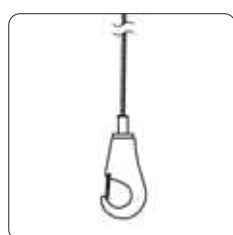
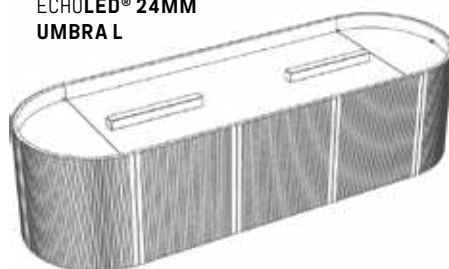

SAFETY HOOK

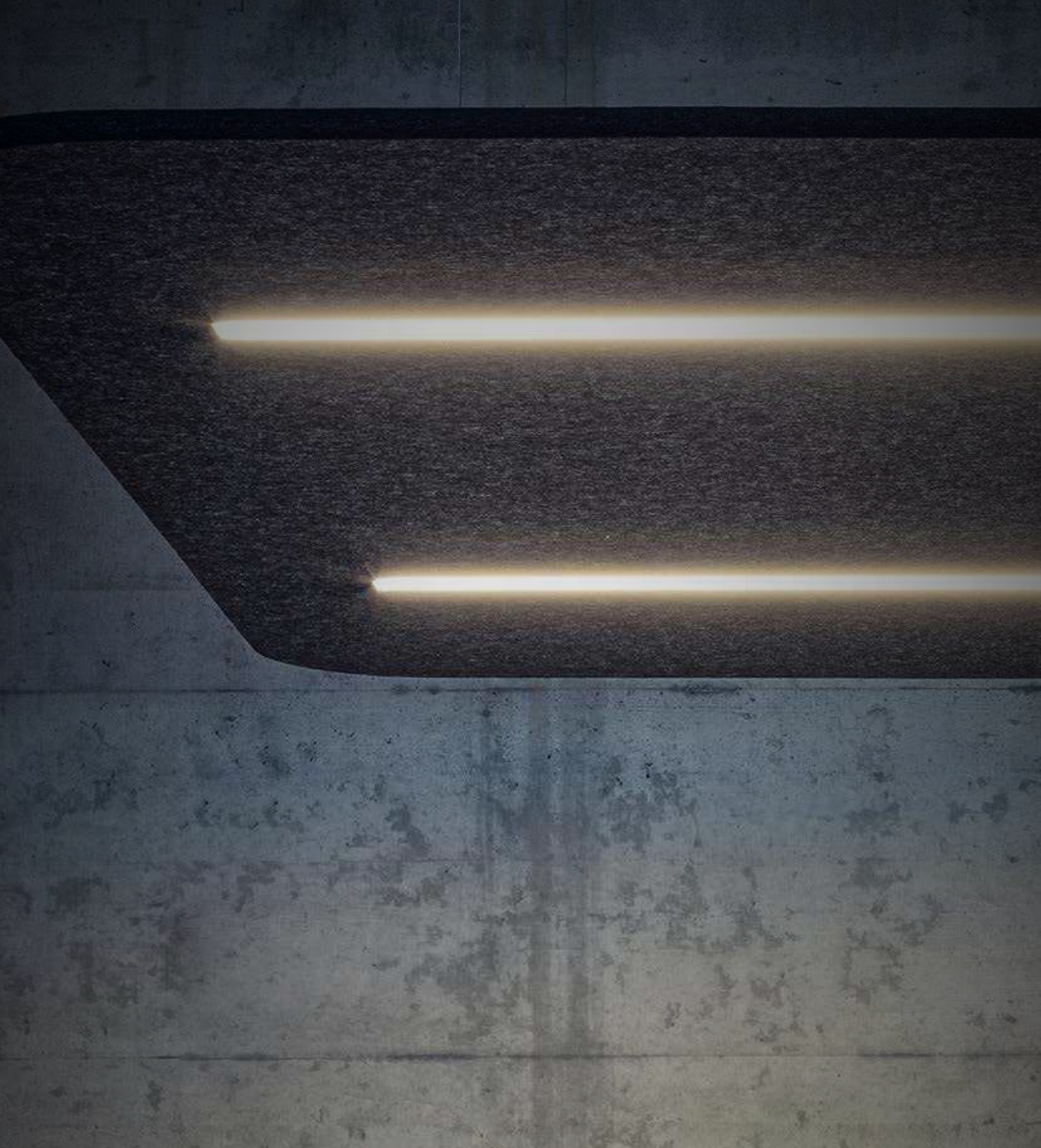

## ECHOLED® LINEAR

For comfort in the workplace, EchoLED® LINEAR was developed with a high-performance absorber and fully integrated linear luminaire. A combination of light quality, functionality and acoustic well-being for employees, paired with durability, maintenance safety and modularity. The fully assembled product only needs to be suspended and connected.



COMPANY PROFILE

MATERIAL

CEILING

LIGHTING

WALLS

PARTITIONS

FURNITURE

ADDITIONAL ITEMS

CREATE



# ECHOLED® 24MM LINEAR

Acoustic sail with fully integrated lighting with DALI dimming mode incl. substructure and suspension. Supplied without plug. The EchoLED® LINEAR luminaire is suspended with frame and safety hook. The frame is white as standard and can be supplied in other colours to order.

Absorption coefficient: aw 1.00, class A

Edge finish: 90°, corner radius 200mm

ON/OFF control available on request.

3000K auf Anfrage erhältlich. (Page 213)

NAME	ARTICLE	W x H x D (in mm)	UNIT	PET-BOTTLES
EchoLED® 24mm LINEAR M2 RECTANGLE L	1110	2380x74x1800	1 pce	303
EchoLED® 24mm LINEAR M1 RECTANGLE L	1111	2380x74x1800	1 pce	303
EchoLED® 24mm LINEAR M1 SQUARE	1112	1800x74x1800	1 pce	230
EchoLED® 24mm LINEAR L2 RECTANGLE L	1113	2380x74x1800	1 pce	303
EchoLED® 24mm LINEAR L1 RECTANGLE L	1114	2380x74x1800	1 pce	303
EchoLED® 24mm LINEAR L1 RECTANGLE M	1115	2380x74x1180	1 pce	199

**ECHOLED® 24MM LINEAR  
M2 RECTANGLE L**

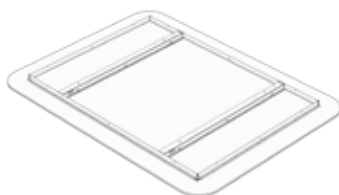

**ECHOLED® 24MM LINEAR  
M1 RECTANGLE L**



**ECHOLED® 24MM LINEAR  
M1 SQUARE**

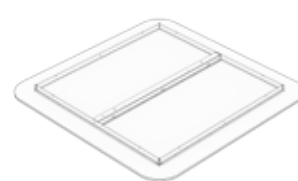

**ECHOLED® 24MM LINEAR  
L2 RECTANGLE L**

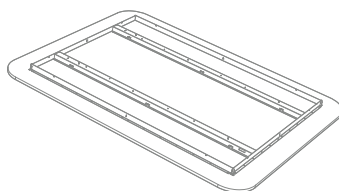

**ECHOLED® 24MM LINEAR  
L1 RECTANGLE L**



**ECHOLED® 24MM LINEAR  
L1 RECTANGLE M**

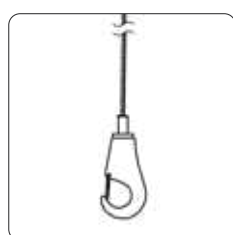

**SAFETY HOOK**



## ECHOLED® BEAM

The high-quality linear luminaire is framed in EchoBoard® for improved room acoustics. The quality luminaire developed with Bartenbach is characterised by energy efficiency, easy maintenance and excellent glare protection ( $UGR < 15$ ). The module is DALI dimmable and offers all the possibilities of digital lighting control.



COMPANY PROFILE

MATERIAL

CEILING

LIGHTING

WALLS

PARTITIONS

FURNITURE

ADDITIONAL ITEMS

CREATE



# ECHOLED® 24MM BEAM

Acoustic baffle with fully integrated lighting with DALI dimming mode incl. substructure and suspension. Supplied without plug.  
ON/OFF control available on request

NAME	ARTICLE	W x H x D (in mm)	UNIT	PET-BOTTLES
EchoLED® 24mm BEAM PLAIN L	1099	2090x290x109mm	1 Pce	87
EchoLED® 24mm BEAM PLAIN M	1098	1510x290x109mm	1 Pce	65
EchoLED® 24mm BEAM HORIZON L	1784	2090x290x109mm	1 Pce	87
EchoLED® 24mm BEAM HORIZON M	1786	1510x290x109mm	1 Pce	65
EchoLED® 24mm BEAM VERTIGO L	1785	2090x290x109mm	1 Pce	87
EchoLED® 24mm BEAM VERTIGO M	1787	1510x290x109mm	1 Pce	65

ECHOLED® 24MM  
BEAM PLAIN L

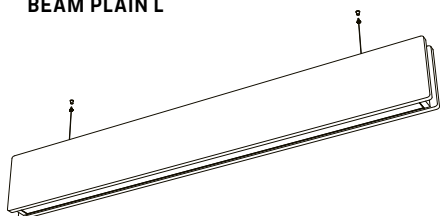

ECHOLED® 24MM  
BEAM PLAIN M

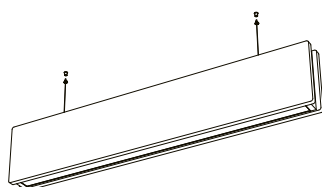

ECHOLED® 24MM  
BEAM HORIZON L

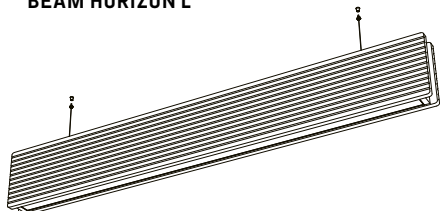

ECHOLED® 24MM  
BEAM HORIZON M

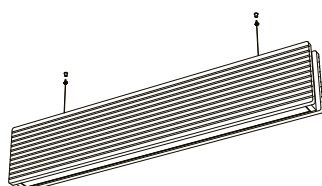

ECHOLED® 24MM  
BEAM VERTIGO L

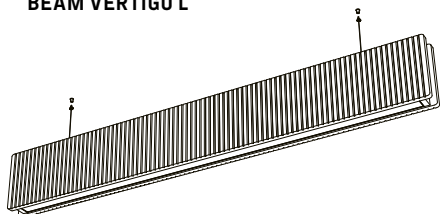

ECHOLED® 24MM  
BEAM VERTIGO M

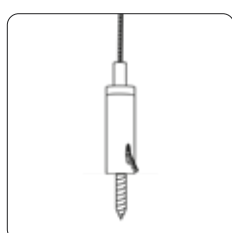
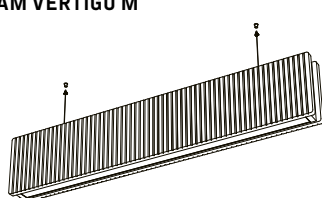

DIRECTLY SCREWED



## ECHOLED® BAFFLE

The high-quality linear luminaire is framed in EchoBoard® for improved room acoustics. The quality luminaire developed with Bartenbach is characterised by energy efficiency, easy maintenance and excellent glare protection ( $UGR < 15$ ). The module is DALI dimmable and offers all the possibilities of digital lighting control.



COMPANY PROFILE

MATERIAL

CEILING

LIGHTING

WALLS

PARTITIONS

FURNITURE

ADDITIONAL ITEMS

CREATE



# ECHOLED® 24MM BAFFLE

Acoustic baffle with integrated LED strips incl. suspension. Supplied without plug.

ON/OFF control available on request

Slatted ceilings without LED strips are available as EchoBaffle®. (Page 46)

Individual slats with LED strips are available as EchoLED® LAMELLA. (Page 98)

NAME	ARTICLE	W x H x D (in mm)	UNIT	PET-BOTTLES
EchoLED® 24mm BAFFLE PLAIN	1781	2400x2000x235mm	1 Pce	395
EchoLED® 24mm BAFFLE CORNER	1782	2400x2000x235mm	1 Pce	379
EchoLED® 24mm BAFFLE VOGUE	1783	2400x2000x235mm	1 Pce	383

**ECHOLED® 24MM  
BAFFLE PLAIN**

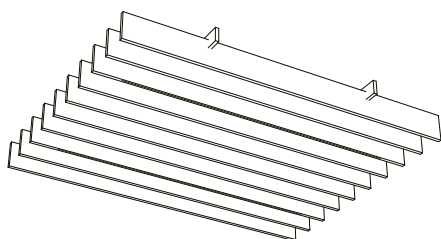

**ECHOLED® 24MM  
BAFFLE CORNER**

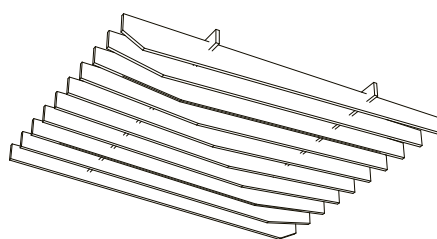

**ECHOLED® 24MM  
BAFFLE VOGUE**

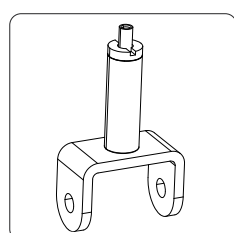
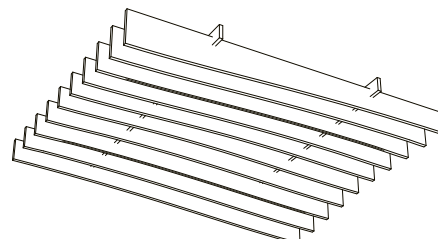

**SUSPENSION SET**

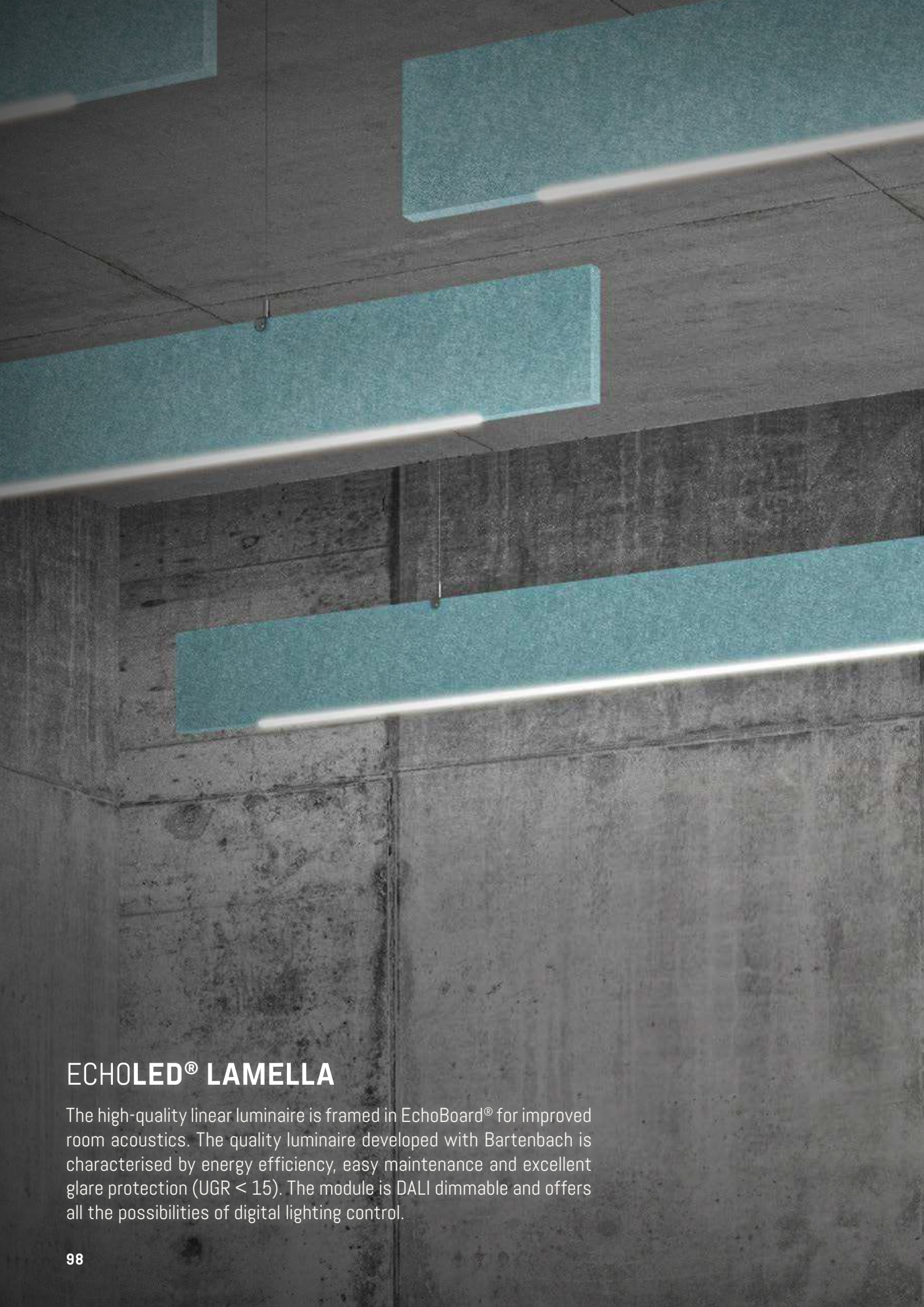

## ECHOLED® LAMELLA

The high-quality linear luminaire is framed in EchoBoard® for improved room acoustics. The quality luminaire developed with Bartenbach is characterised by energy efficiency, easy maintenance and excellent glare protection ( $UGR < 15$ ). The module is DALI dimmable and offers all the possibilities of digital lighting control.

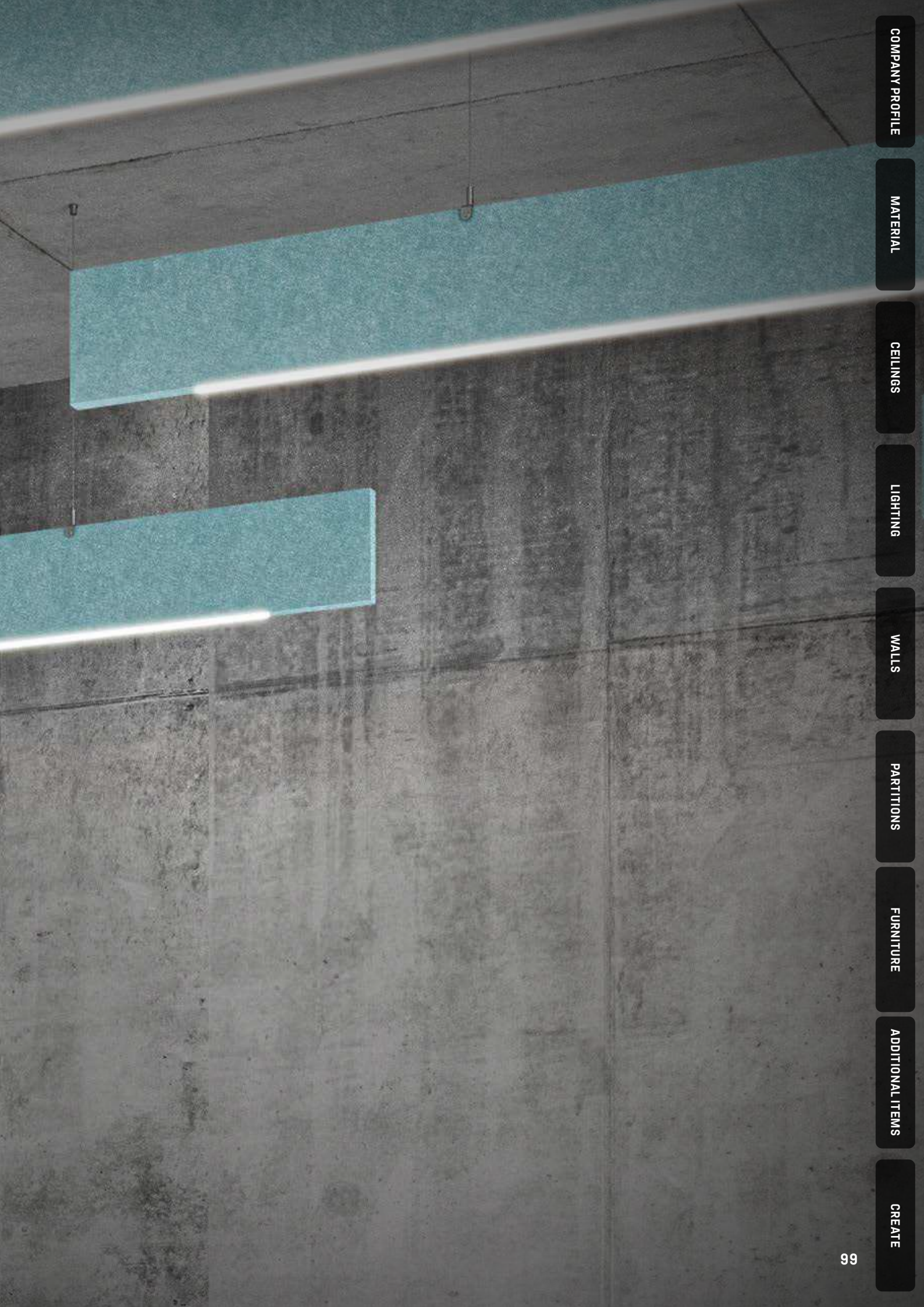

COMPANY PROFILE

MATERIAL

CEILING

LIGHTING

WALLS

PARTITIONS

FURNITURE

ADDITIONAL ITEMS

CREATE



# ECHOLED® 24MM LAMELLA

Acoustic lamella with integrated LED strip incl. suspension. Supplied without plug.

ON/OFF control available on request.

Also available integrated into slatted ceilings as EchoLED® BAFFLE. (Page 94)

NAME	ARTICLE	W x H x D (in mm)	UNIT	PET-BOTTLES
EchoLED® 24mm LAMELLA PLAIN (1 Pce)	1788	2400x195x24mm	1 Pce	94
EchoLED® 24mm LAMELLA PLAIN (2 Pce)	1789	2400x195x24mm	2 Pce	188
EchoLED® 24mm LAMELLA CORNER (1 Pce)	1790	2400x195x24mm	1 Pce	77
EchoLED® 24mm LAMELLA CORNER (2 Pce)	1791	2400x195x24mm	2 Pce	154
EchoLED® 24mm LAMELLA VOGUE (1 Pce)	1792	2400x195x24mm	1 Pce	82
EchoLED® 24mm LAMELLA VOGUE (2 Pce)	1793	2400x195x24mm	2 Pce	164

ECHOLED® 24MM  
LAMELLA PLAIN

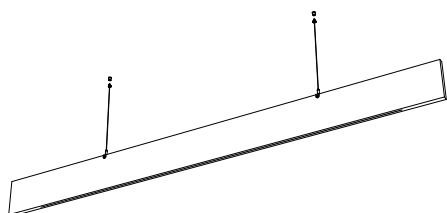

ECHOLED® 24MM  
LAMELLA CORNER

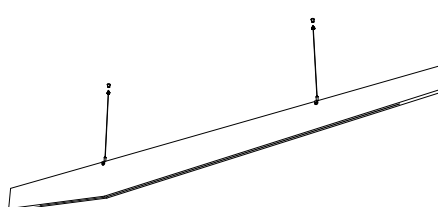

ECHOLED® 24MM  
LAMELLA VOGUE

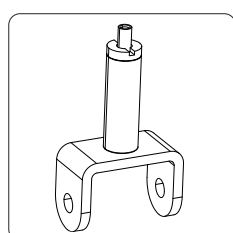
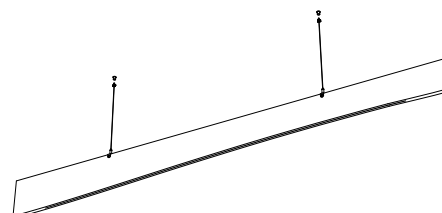

SUSPENSION SET





COMPANY PROFILE

MATERIAL

CEILING

LIGHTING

WALLS

PARTITIONS

FURNITURE

ADDITIONAL ITEMS

CREATE

## ACOUSTIC-WALLS

Sound absorbers for wall mounting are an effective alternative to acoustic ceilings, especially in small and narrow rooms: space-saving, individually designable and flexibly applicable, acoustic walls offer sophisticated solutions.



## ECHOBaffle® WALL

EchoBaffle® WALL is a new type of wall absorber with three-dimensional slats that come to life as you walk by. EchoBaffle® WALL opens up a new field for acoustic wall design. With changing viewing angles, three-dimensional shapes become visible and disappear again, particularly effective on long walls or corridors.

The EchoBaffles® impress with their simple installation using a tool-free plug-in system. The open structure leaves room for building technology such as sensors, switches or sockets. In addition, individual EchoBaffles® can be removed very easily if required. Discover the new wall solution, which we offer in four designs up to 2.80 metres high.



COMPANY PROFILE

MATERIAL

CEILING

LIGHTING

WALLS

PARTITIONS

FURNITURE

ADDITIONAL ITEMS

CREATE

# ECHOBaffle® 12MM WALL

Acoustic wall baffles consisting of baffle blades incl. substructure and suspension profiles.

Individual EchoBaffle® solutions available on request!

You can always find the latest designs on our website: [www.echojazz.com/echobaffle-wall](http://www.echojazz.com/echobaffle-wall)



NAME	ARTICLE	W x H x D (in mm)	UNIT	PET-BOTTLES
EchoBaffle® WALL 12mm DIAMOND	1250	1350x2800x110mm	1 Pce	262
EchoBaffle® WALL 12mm PLAIN	1251	1350x2800x113mm	1 Pce	321
EchoBaffle® WALL 12mm TILT	1252	1350x2800x92mm	1 Pce	321
EchoBaffle® WALL 12mm WAVE	1253	1350x2800x125mm	1 Pce	299

ECHOBaffle® WALL 12MM  
DIAMOND



ECHOBaffle® WALL  
12MM PLAIN

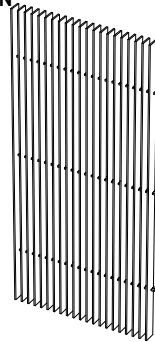

ECHOBaffle® WALL 12MM  
TILT

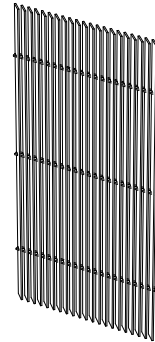

ECHOBaffle® WALL 12MM  
WAVE

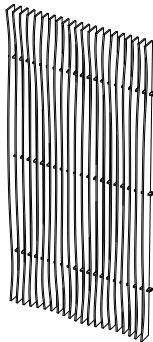

# ECHOBaffle® 24MM WALL

Acoustic wall baffles consisting of baffle blades incl. substructure and suspension profiles.

Individual EchoBaffle® solutions available on request!

You can always find the latest designs on our website: [www.echojazz.com/echobaffle-wall](http://www.echojazz.com/echobaffle-wall)



NAME	ARTICLE	W x H x D (in mm)	UNIT	PET-BOTTLES
EchoBaffle® WALL 24mm DIAMOND	1254	1350x2400x103mm	1 Pce	244
EchoBaffle® WALL 24mm PLAIN	1255	1350x2400x103mm	1 Pce	302
EchoBaffle® WALL 24mm TILT	1256	1350x2400x94mm	1 Pce	302
EchoBaffle® WALL 24mm WAVE	1257	1350x2400x131mm	1 Pce	282

**ECHOBaffle® WALL 24MM  
DIAMOND**

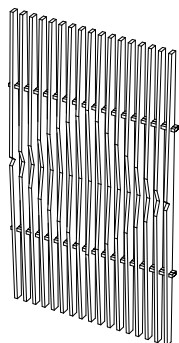

**ECHOBaffle® WALL 24MM  
PLAIN**

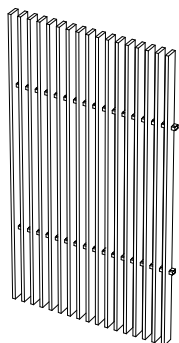

**ECHOBaffle® WALL 24MM  
TILT**

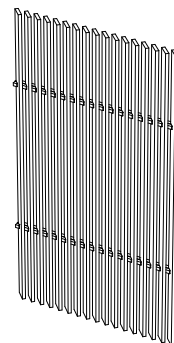

**ECHOBaffle® WALL 24MM  
WAVE**

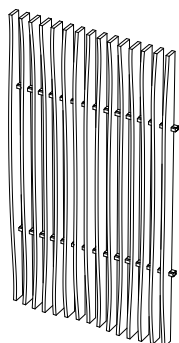



## ECHOFIELD® ORNAMENT

EchoField® ORNAMENT is the perfect solution for a striking and practical wall design. The wall panel can be customised with individual perforations for an impressive look. Alternatively, the ornament can also be designed as a three-dimensional pattern with raised or lowered areas.

With its magnetic substructure, it offers versatile application possibilities and is ideal for covering uneven and fragmented walls. Thanks to the wall spacing, improved sound absorption is achieved, which positively influences the room acoustics. The quick-release system ensures easy access to areas behind it, such as facility services.

The EchoFiel® ORNAMENT wall panel is made recycled PET, which not only makes it environmentally friendly, but also gives it excellent durability and longevity. Design your interiors with EchoField® wall panels exactly as you want them, even with your own design



COMPANY PROFILE

MATERIAL

CEILING

LIGHTING

WALLS

PARTITIONS

FURNITURE

ADDITIONAL ITEMS

CREATE

# ECHOFIELD® 12MM ORNAMENT

Acoustic panels in various shapes and surface designs incl. magnetic wall suspension.

Absorption coefficient:  $\alpha_w$  0.60

Edge processing: 90°, corner radii 40mm

This product is available with our perforations. [\(Page 241\)](#)

NAME	ARTICLE	W x H x D (in mm)	UNIT	PET-BOTTLES
EchoField® 12mm ORNAMENT PLAIN	1259	1200x2800x49	1 Pce	168
EchoField® 12mm ORNAMENT PERFORATED	1468	1200x2800x49	1 Pce	144
EchoField® 12mm ORNAMENT EMBOSSED	1467	1200x2800x55	1 Pce	168
EchoField® 12mm ORNAMENT DEBOSSSED	1466	1200x2800x49	1 Pce	168

ECHOFIELD® 12MM ORNAMENT  
PLAIN

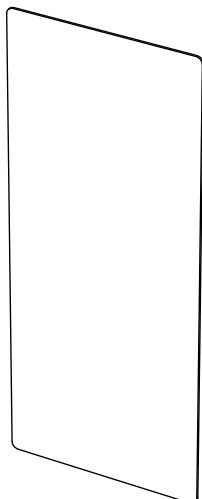

ECHOFIELD® 12MM ORNAMENT  
PERFORATED

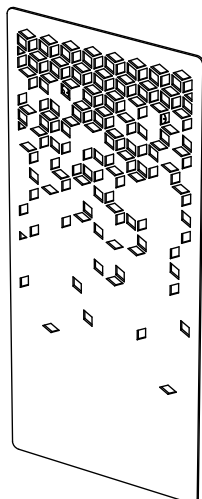

ECHOFIELD® 12MM ORNAMENT  
EMBOSSED

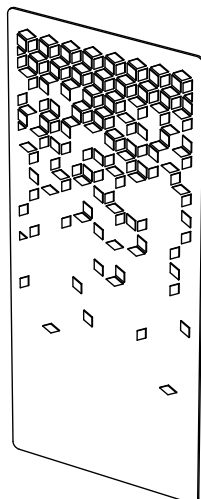

ECHOFIELD® 12MM ORNAMENT  
DEBOSSSED

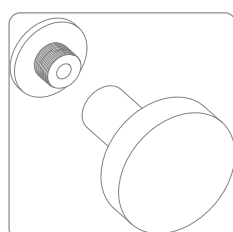
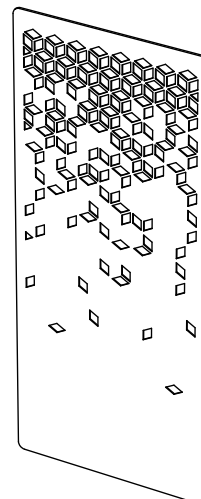

SUSPENSION WITH MAGNETS

# ECHOFIELD® 24MM ORNAMENT

Acoustic panels in various shapes and surface designs incl. magnetic wall suspension.

Absorption coefficient:  $\alpha_w$  0.65

Edge processing: 90°, corner radii 40mm

This product is available with our perforations. [\(Page 241\)](#)

NAME	ARTICLE	W x H x D (in mm)	UNIT	PET-BOTTLES
EchoField® 24mm ORNAMENT PLAIN	1265	1800x2400x61	1 Pce	303
EchoField® 24mm ORNAMENT PERFORATED	1471	1800x2400x61	1 Pce	268
EchoField® 24mm ORNAMENT EMBOSSED	1470	1800x2400x67	1 Pce	303
EchoField® 24mm ORNAMENT DEBOSSSED	1469	1800x2400x61	1 Pce	303

ECHOFIELD® 24MM ORNAMENT  
PLAIN

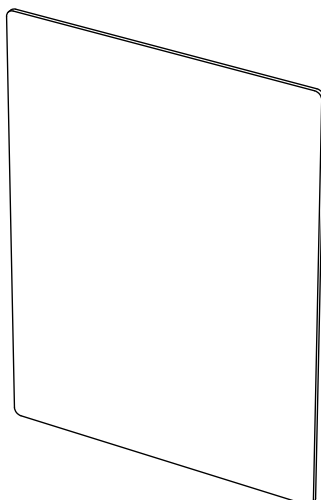

ECHOFIELD® 24MM ORNAMENT  
PERFORATED

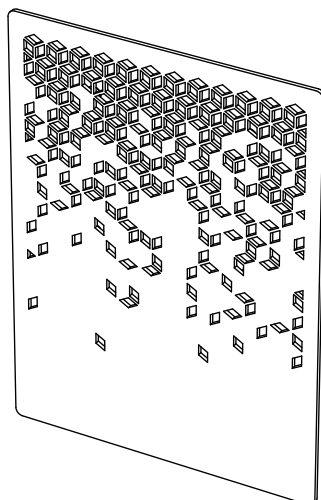

ECHOFIELD® 24MM ORNAMENT  
EMBOSSED

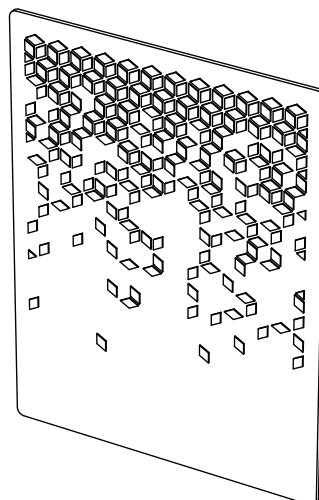

ECHOFIELD® 24MM ORNAMENT  
DEBOSSSED

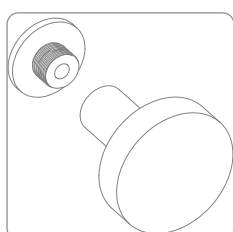
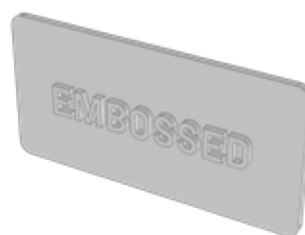
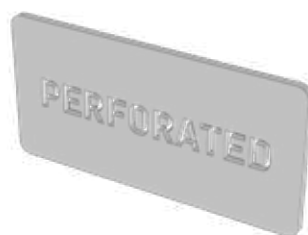
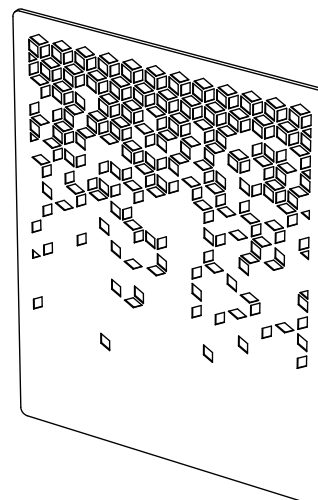

SUSPENSION WITH MAGNETS

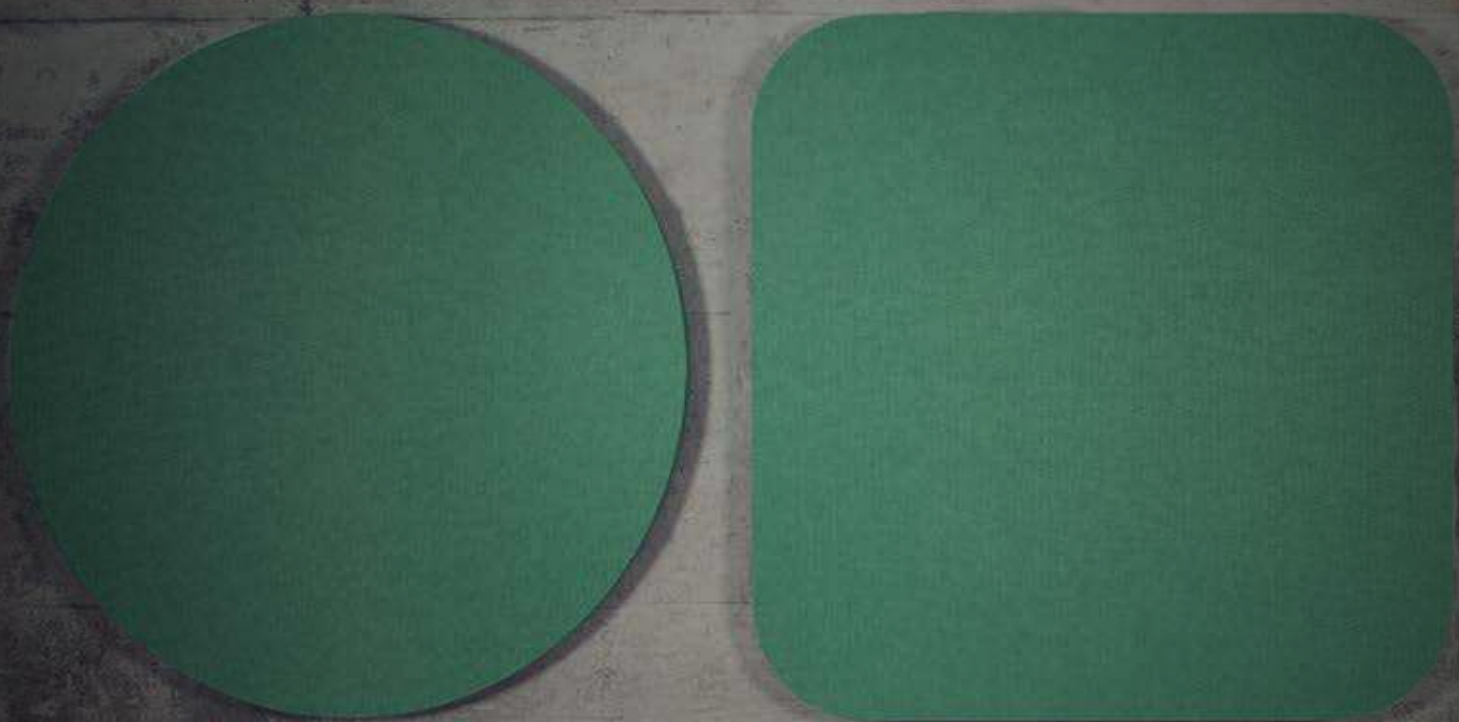

## ECHOFIELD®

The EchoField® panels are fixed with a cavity to the wall and provide optimal acoustic performance especially in small and narrow rooms. They are an alternative to EchoSail® ceiling sails, with which they share dimensions and shapes. They are mounted using a powder-coated metal frame that is simply plugged in and suspended using a wall profile.



COMPANY PROFILE

MATERIAL

CEILING

LIGHTING

WALLS

PARTITIONS

FURNITURE

ADDITIONAL ITEMS

CREATE

# ECHOFIELD® 12MM

Acoustic panels in various shapes and surface designs incl. wall suspension

Absorption coefficient:  $\alpha_w$  0.90, class A

Edge finish: 90°, corner radius 200mm

NAME	ARTICLE	W x H x D (in mm)	UNIT	PET-BOTTLES
EchoField® 12mm HEXAGON M	1258	1180x1078x62	2 pce	99
EchoField® 12mm RECTANGLE M	1260	2380x1180x62	1 pce	140
EchoField® 12mm ROUND M	1261	Ø1180x62	2 pce	109
EchoField® 12mm SQUARE M	1262	1180x1180x62	2 pce	139

ECHOFIELD® 12MM  
HEXAGON

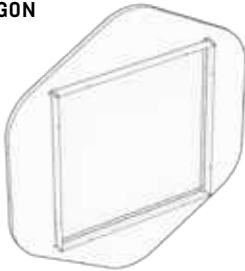

ECHOFIELD® 12MM  
RECTANGLE

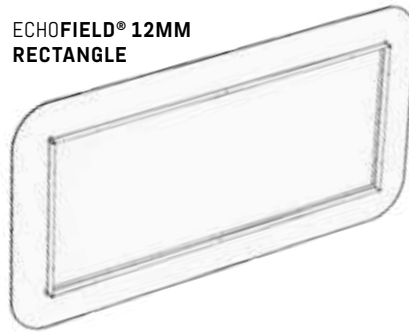

ECHOFIELD® 12MM  
ROUND



ECHOFIELD®  
12MM SQUARE

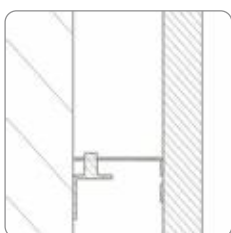

WANDHALTERUNG

# ECHOFIELD® 24MM

Acoustic panels in various shapes and surface designs incl. wall suspension

Absorption coefficient:  $\alpha_w$  1.00, class A

Edge finish: 90°, corner radius 200mm

NAME	ARTICLE	W x H x D (in mm)	UNIT	PET-BOTTLES
EchoField® 24mm HEXAGON M	1263	1180x1078x74	2 pce	141
EchoField® 24mm HEXAGON L	1264	1800x1645x74	1 pce	165
EchoField® 24mm RECTANGLE M	1266	2380x1180x74	1 pce	199
EchoField® 24mm RECTANGLE L	1267	2380x1800x74	1 pce	303
EchoField® 24mm ROUND M	1268	Ø1180x74	2 pce	155
EchoField® 24mm ROUND L	1269	Ø1800x74	1 pce	180
EchoField® 24mm SQUARE M	1270	1180x1180x74	2 pce	197
EchoField® 24mm SQUARE L	1271	1800x1800x74	1 pce	230

**ECHOFIELD® 24MM  
HEXAGON M**



**ECHOFIELD® 24MM  
HEXAGON L**

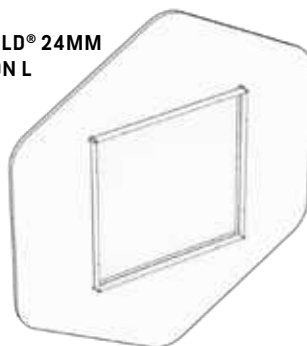

**ECHOFIELD® 24MM  
RECTANGLE M**

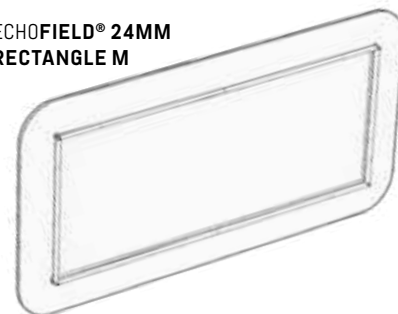

**ECHOFIELD® 24MM  
RECTANGLE L**

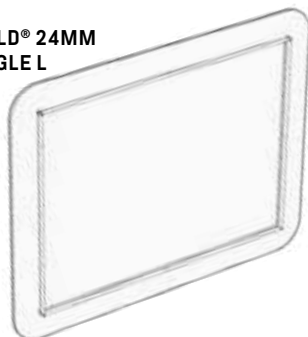

**ECHOFIELD® 24MM  
ROUND M**

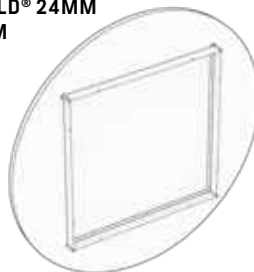

**ECHOFIELD® 24MM  
ROUND L**

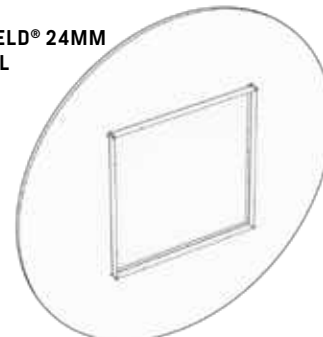

**ECHOFIELD® 24MM  
SQUARE M**



**ECHOFIELD® 24MM  
SQUARE L**

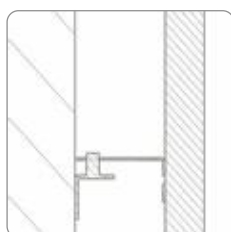
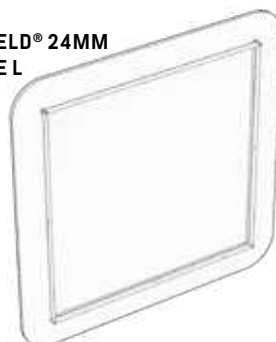

**WANDHALTERUNG**



## ECHOBRIK®

Acoustic wall absorbers offer a good alternative to ceiling elements, especially in small and medium-sized meeting rooms where ceiling absorbers are not effective due to flutter sound. Installation is done using EchoGlue® spray contact adhesive. The acoustic panels can be easily combined with each other and complemented in colour thanks to broken edges.



COMPANY PROFILE

MATERIAL

CEILING

LIGHTING

WALLS

PARTITIONS

FURNITURE

ADDITIONAL ITEMS

CREATE

# ECHOBRICK® 12MM

Acoustic wall tiles with bevelling. Installation by means of EchoGlue® spray adhesive (included).

Absorption coefficient:  $\alpha_w$  0.30/0.60 (0mm/50mm wall spacing)

Edge finish: 45° bevelling

Special dimensions and designs on request

The latest designs can always be found online at [www.echojazz.com/echobrick](http://www.echojazz.com/echobrick)

NAME	ARTICLE	W x H x D (in mm)	UNIT	PET-BOTTLES
EchoBrick® 12mm BOLLIWOOD	1011	2800x280x12	Set of 4	157
EchoBrick® 12mm BOOMERANG	1299	520x300x12	Set of 40	156
EchoBrick® 12mm CELL	1300	600x693x12	Set of 8	125
EchoBrick® 12mm DIAGONAL L	1302	600x600x12	Set of 8	144
EchoBrick® 12mm DIAGONAL M	1301	300x300x12	Set of 36	162
EchoBrick® 12mm DIAMOND L	1337	793x458x12	Set of 12	109
EchoBrick® 12mm DIAMOND M	1303	397x229x12	Set of 58	132
EchoBrick® 12mm GRADIENT	1537	255x294x12	Set of 48	135
EchoBrick® 12mm HEXAGON L	1415	693x600x12	Set of 8	125
EchoBrick® 12mm HEXAGON M	1383	294x255x12	Set of 48	191
EchoBrick® 12mm KALEIDO	1476	600x693x12	Set of 8	125
EchoBrick® 12mm PLANK M	1553	300x1400x12	Set of 8	168
EchoBrick® 12mm PLANK L	1565	300x2800x12	Set of 4	168
EchoBrick® 12mm PUZZLE	1570	677x677x12	Set of 10	135
EchoBrick® 12mm SHIELD	1574	590x288x12	Set of 20	128
EchoBrick® 12mm TANGRAM	1575	2800x1200x12	Set of 35	144
EchoBrick® 12mm WALL L	1584	600x300x12	Set of 18	162
EchoBrick® 12mm WALL M	1583	300x150x12	Set of 72	162

**ECHOBRICK® 12MM  
BOLLIWOOD**

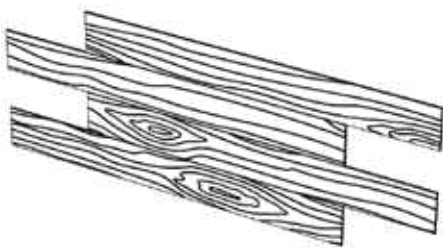

**ECHOBRICK® 12MM  
BOOMERANG**

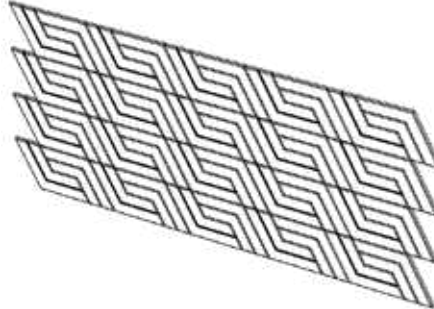

**ECHOBRICK® 12MM  
CELL**

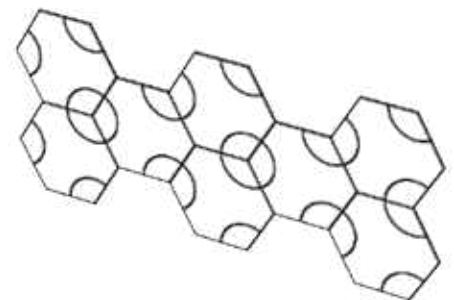

**ECHOBRICK® 12MM  
DIAGONAL L**

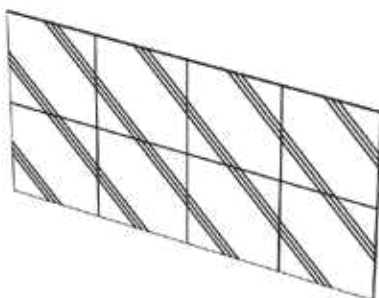

**ECHOBRICK® 12MM  
DIAGONAL M**

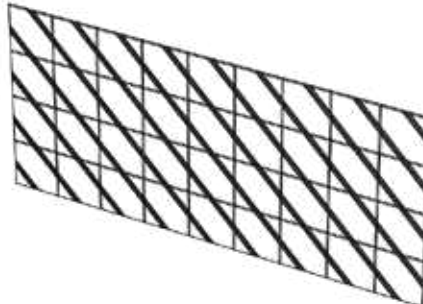

**ECHOBRICK® 12MM  
DIAMOND L**

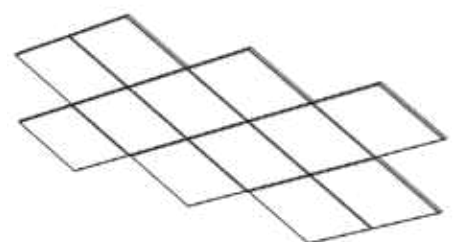

**ECHOBRICK® 12MM  
DIAMOND M**

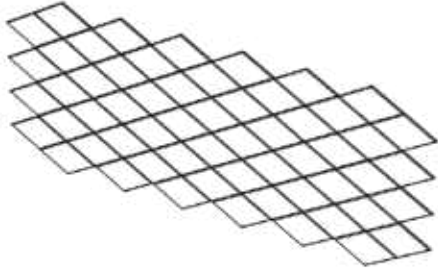

**ECHOBRICK® 12MM  
GRADIENT**

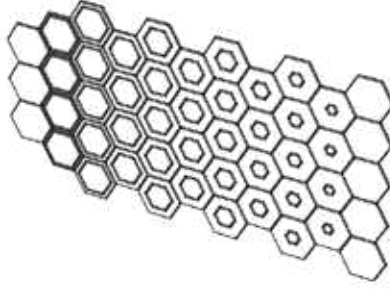

**ECHOBRICK® 12MM  
HEXAGON L**

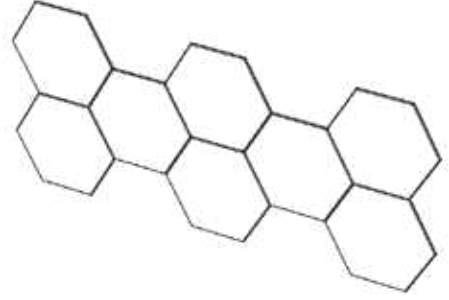

**ECHOBRICK® 12MM  
HEXAGON M**

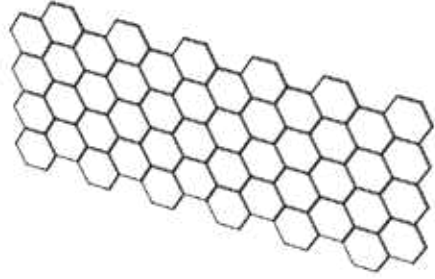

**ECHOBRICK® 12MM  
KALEIDO**

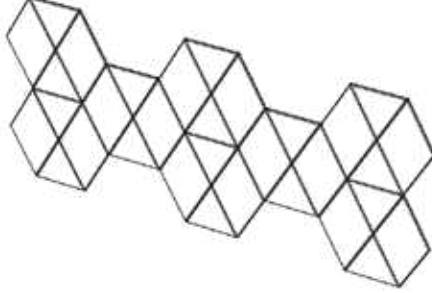

**ECHOBRICK® 12MM  
PLANK M**

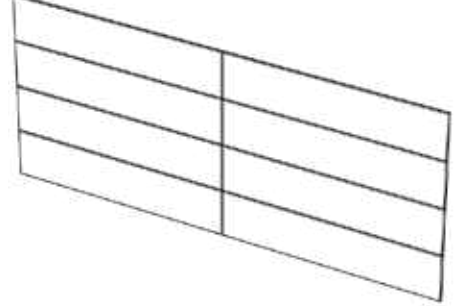

**ECHOBRICK® 12MM  
PLANK L**

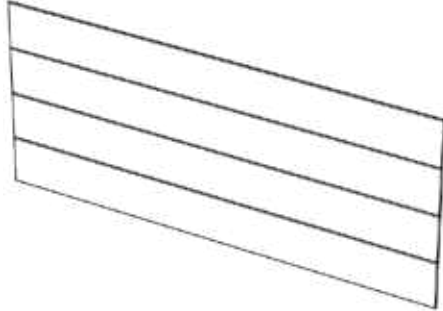

**ECHOBRICK® 12MM  
PUZZLE**

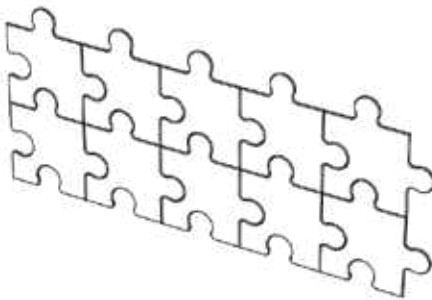

**ECHOBRICK® 12MM  
SHIELD**

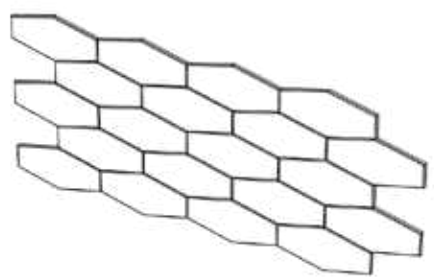

**ECHOBRICK® 12MM  
TANGRAM**

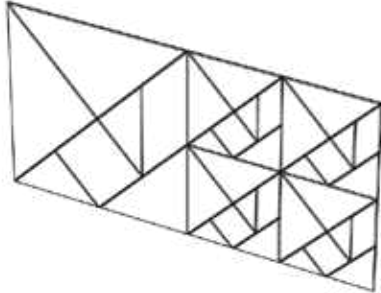

**ECHOBRICK® 12MM  
WALL L**

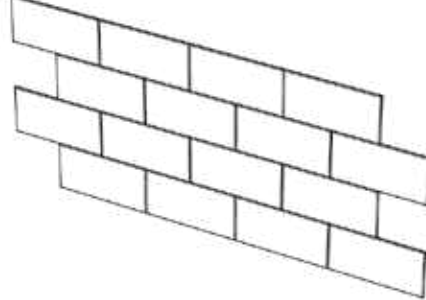

**ECHOBRICK® 12MM  
WALL M**

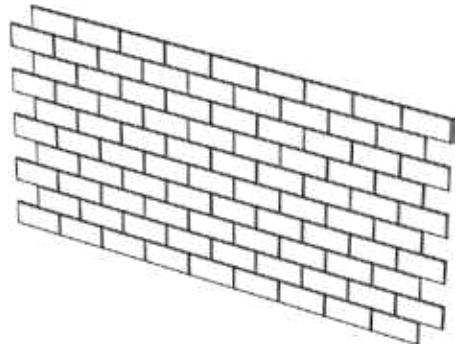

# ECHOBRICK® 24MM

Acoustic wall tiles with bevelling. Installation by means of EchoGlue® spray adhesive (included).

Absorption coefficient:  $\alpha_w$  0.50/0.65 (0mm/50mm wall spacing)

Edge finish: 45° bevelling

Special dimensions and designs on request

The latest designs can always be found online at [www.echojazz.com/echobrick](http://www.echojazz.com/echobrick)

NAME	ARTICLE	W x H x D (in mm)	UNIT	PET-BOTTLES
EchoBrick® 24mm BOLLIWOOD	1012	2400x280x24	Set of 6	285
EchoBrick® 24mm BOOMERANG	1586	520x300x24	Set of 48	265
EchoBrick® 24mm CELL	1587	600x693x24	Set of 11	243
EchoBrick® 24mm DIAGONAL L	1590	600x600x24	Set of 12	306
EchoBrick® 24mm DIAGONAL M	1588	300x300x24	Set of 48	306
EchoBrick® 24mm DIAMOND L	1597	793x458x24	Set of 15	193
EchoBrick® 24mm DIAMOND M	1591	397x229x24	Set of 77	269
EchoBrick® 24mm GRADIENT	1603	255x294x24	Set of 65	259
EchoBrick® 24mm HEXAGON L	1601	693x600x24	Set of 11	243
EchoBrick® 24mm HEXAGON M	1600	294x255x24	Set of 65	259
EchoBrick® 24mm KALEIDO	1602	600x693x24	Set of 11	243
EchoBrick® 24mm PLANK M	1604	300x1200x24	Set of 12	306
EchoBrick® 24mm PLANK L	1605	300x2400x24	Set of 6	306
EchoBrick® 24mm PUZZLE	1606	677x677x24	Set of 12	230
EchoBrick® 24mm SHIELD	1607	590x288x24	Set of 28	253
EchoBrick® 24mm TANGRAM	1608	2380x1770x24	Set of 28	296
EchoBrick® 24mm WALL L	1610	600x300x24	Set of 24	306
EchoBrick® 24mm WALL M	1609	300x150x24	Set of 96	306

**ECHOBRICK® 24MM  
BOLLIWOOD**

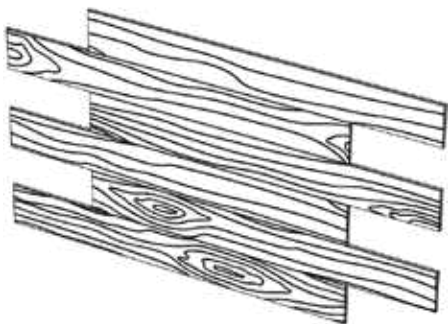

**ECHOBRICK® 24MM  
BOOMERANG**

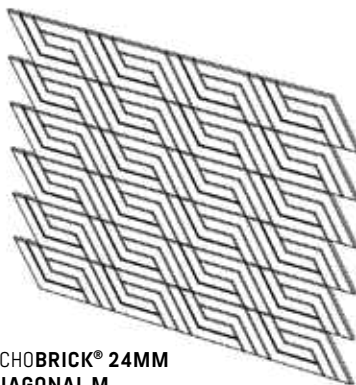

**ECHOBRICK® 24MM  
CELL**

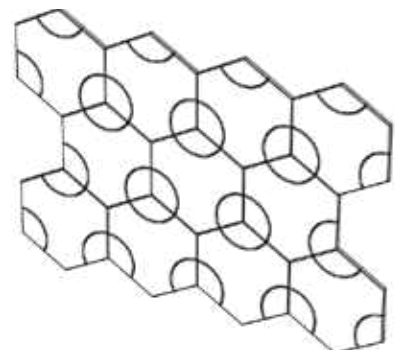

**ECHOBRICK® 24MM  
DIAGONAL L**

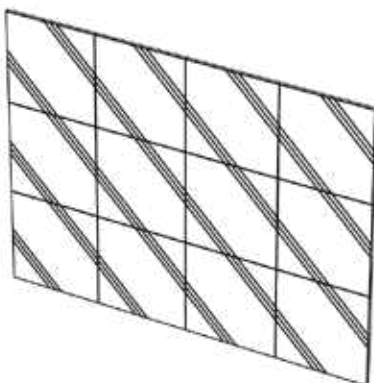

**ECHOBRICK® 24MM  
DIAGONAL M**

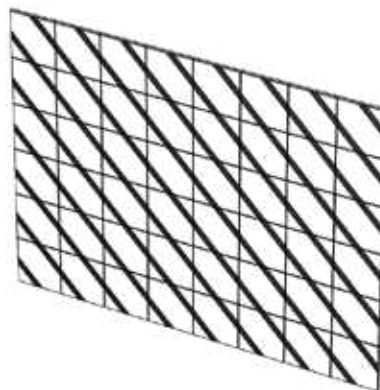

**ECHOBRICK® 24MM  
DIAMOND L**

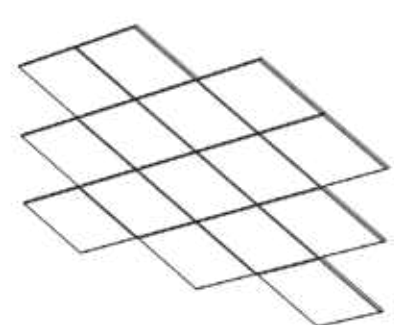

**ECHOBRICK® 24MM  
DIAMOND M**

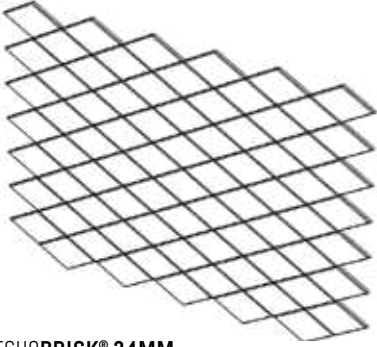

**ECHOBRICK® 24MM  
GRADIENT**

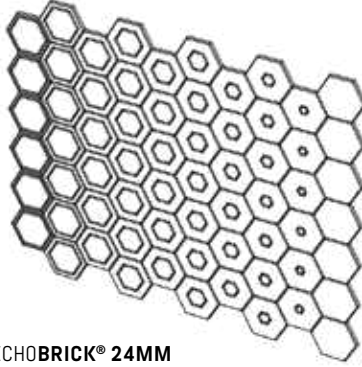

**ECHOBRICK® 24MM  
HEXAGON L**

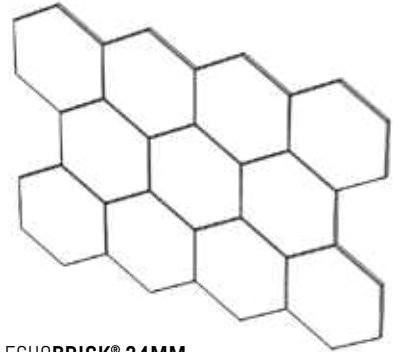

**ECHOBRICK® 24MM  
HEXAGON M**



**ECHOBRICK® 24MM  
KALEIDO**

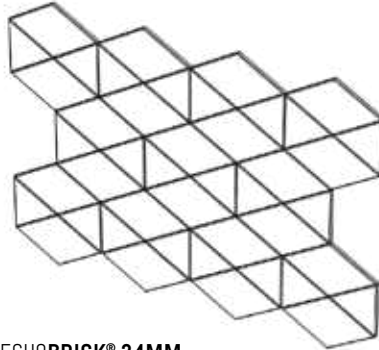

**ECHOBRICK® 24MM  
PLANK M**

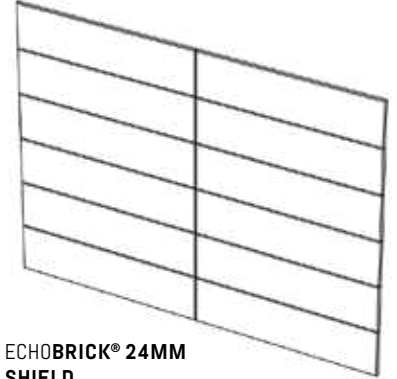

**ECHOBRICK® 24MM  
PLANK L**

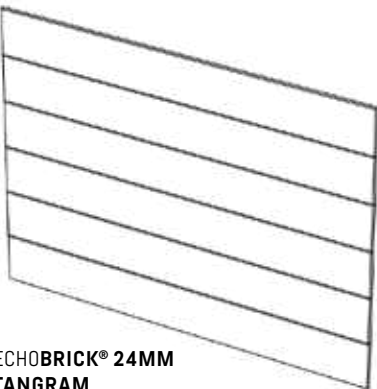

**ECHOBRICK® 24MM  
PUZZLE**

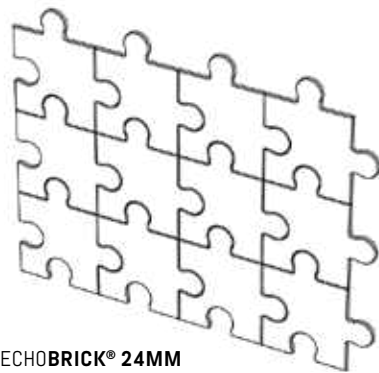

**ECHOBRICK® 24MM  
SHIELD**

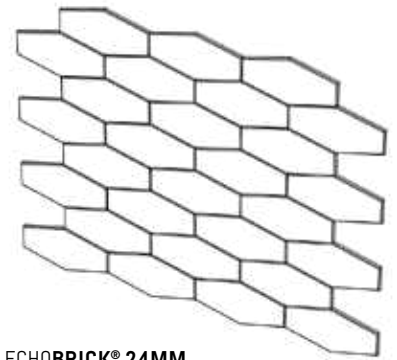

**ECHOBRICK® 24MM  
TANGRAM**

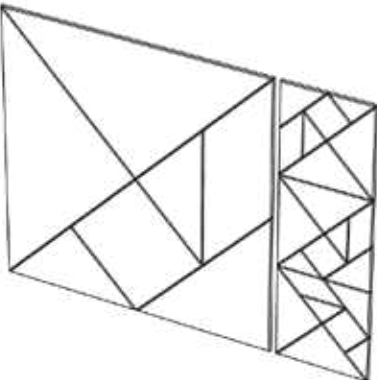

**ECHOBRICK® 24MM  
WALL L**

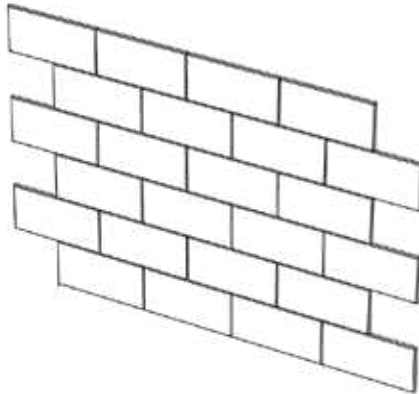

**ECHOBRICK® 24MM  
WALL M**

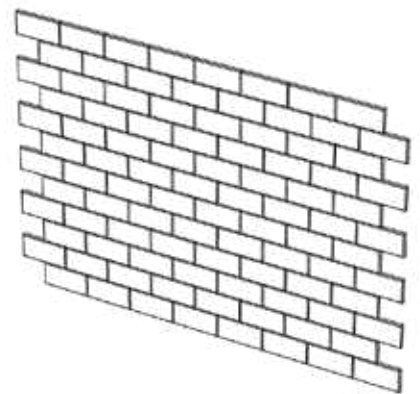

## ECHOMONOC®

EchoMonoc® is suitable for large-area wall applications without visible joints. For improved acoustic performance, it is recommended to use the 24mm thick option. ECHO**JAZZ** absorbers made of recycled PET are extremely robust and suitable for regular cleaning and disinfection. Installation is quick and easy with EchoGlue® adhesive contact spray.

Indented carvings break up the monochrome surface. This finishing method creates an indented structure that gives each room its own character.

COMPANY PROFILE

MATERIAL

CEILING

LIGHTING

WALLS

PARTITIONS

FURNITURE

ADDITIONAL ITEMS

CREATE

# ECHOMONOC® 12MM

Acoustic wall panels with bevelling. Installation by means of EchoGlue® spray adhesive (included).

Absorption coefficient:  $\alpha_w$  0.30/0.60 (0mm/50mm wall distance)

Special dimensions and designs on request

You can always find the latest designs online at [www.echojazz.com/echomonoc](http://www.echojazz.com/echomonoc)



NAME	ARTICLE	W x H x D (in mm)	UNIT	PET-BOTTLES																													
EchoMonoc® 12mm BALLOON LEFT	1009-100	1200x2800x12	1 pce	168																													
EchoMonoc® 12mm BALLOON RIGHT	1009-100	1200x2800x12	1 pce	168																													
EchoMonoc® 12mm CODE	1009-101	1200x2800x12	1 pce	168																													
EchoMonoc® 12mm DIAGONAL	1009-102	1200x2800x12	1 pce	168																													
EchoMonoc® 12mm FENCE	1009-103	1200x2800x12	1 pce	168																													
EchoMonoc® 12mm FISHBONE	1009-104	1200x2800x12	1 pce	168																													
EchoMonoc® 12mm FLOW	1009-105	1200x2800x12	1 pce	168																													
EchoMonoc® 12mm FRAGMENTS	1009-106	1200x2800x12	1 pce	168																													
EchoMonoc® 12mm KINGSCROSS	1009-107	1200x2800x12	1 pce	168																													
EchoMonoc® 12mm LEAVES	1009-108	1200x2800x12	1 pce	168																													
EchoMonoc® 12mm SEAWEED	1009-109	1200x2800x12	1 pce </tr <tr> <td>EchoMonoc® 12mm SPHERE</td> <td>1009-110</td> <td>1200x2800x12</td> <td>1 pce</td> <td>168</td> </tr> <tr> <td>EchoMonoc® 12mm STREAMS</td> <td>1009-111</td> <td>1200x2800x12</td> <td>1 pce</td> <td>168</td> </tr> <tr> <td>EchoMonoc® 12mm VERTIGO</td> <td>1009-112</td> <td>1200x2800x12</td> <td>1 pce</td> <td>168</td> </tr> <tr> <td>EchoMonoc® 12mm WAVE</td> <td>1009-113</td> <td>1200x2800x12</td> <td>1 pce</td> <td>168</td> </tr> <tr> <td>EchoMonoc® 12mm WOVEN</td> <td>1009-115</td> <td>1200x2800x12</td> <td>1 pce</td> <td>168</td> </tr> <tr> <td>EchoMonoc® 12mm ZIGZAG</td> <td>1009-114</td> <td>1200x2800x12</td> <td>1 pce</td> <td>168</td> </tr>	EchoMonoc® 12mm SPHERE	1009-110	1200x2800x12	1 pce	168	EchoMonoc® 12mm STREAMS	1009-111	1200x2800x12	1 pce	168	EchoMonoc® 12mm VERTIGO	1009-112	1200x2800x12	1 pce	168	EchoMonoc® 12mm WAVE	1009-113	1200x2800x12	1 pce	168	EchoMonoc® 12mm WOVEN	1009-115	1200x2800x12	1 pce	168	EchoMonoc® 12mm ZIGZAG	1009-114	1200x2800x12	1 pce	168
EchoMonoc® 12mm SPHERE	1009-110	1200x2800x12	1 pce	168																													
EchoMonoc® 12mm STREAMS	1009-111	1200x2800x12	1 pce	168																													
EchoMonoc® 12mm VERTIGO	1009-112	1200x2800x12	1 pce	168																													
EchoMonoc® 12mm WAVE	1009-113	1200x2800x12	1 pce	168																													
EchoMonoc® 12mm WOVEN	1009-115	1200x2800x12	1 pce	168																													
EchoMonoc® 12mm ZIGZAG	1009-114	1200x2800x12	1 pce	168																													

ECHOMONOC® 12MM  
BALLOON (LEFT/RIGHT)

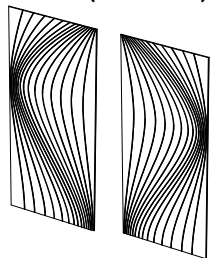

ECHOMONOC® 12MM  
CODE

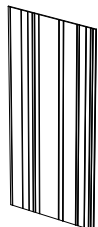

ECHOMONOC® 12MM  
DIAGONAL

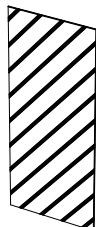

ECHOMONOC® 12MM  
FENCE

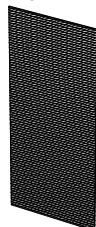

ECHOMONOC® 12MM  
FISHBONE

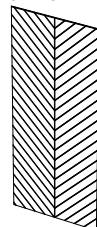

ECHOMONOC® 12MM  
FLOW



ECHOMONOC® 12MM  
FRAGMENTS



ECHOMONOC® 12MM  
KINGSCROSS

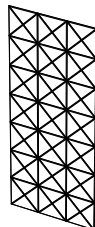

ECHOMONOC® 12MM  
LEAVES



ECHOMONOC® 12MM  
SEAWEED

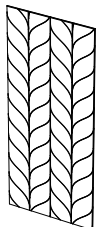

ECHOMONOC® 12MM  
SPHERE



ECHOMONOC® 12MM  
STREAMS



ECHOMONOC® 12MM  
VERTIGO

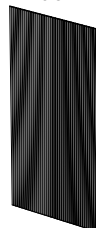

ECHOMONOC® 12MM  
WAVE

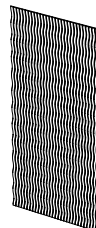

ECHOMONOC® 12MM  
WOVEN



ECHOMONOC® 12MM  
ZIGZAG



# ECHOMONOC® 24MM

Acoustic wall panels with bevelling. Installation by means of EchoGlue® spray adhesive (included).

Absorption coefficient:  $\alpha_w$  0.50/0.65 (0mm/50mm wall distance)

Special dimensions and designs on request

You can always find the latest designs online at [www.echojazz.com/echomonoc](http://www.echojazz.com/echomonoc)



NAME	ARTICLE	W x H x D (in mm)	UNIT	PET-BOTTLES
EchoMonoc® 24mm BALLOON	1531-100	1800x2400x24	1 pce	303
EchoMonoc® 24mm CODE	1531-101	1800x2400x24	1 pce	303
EchoMonoc® 24mm DIAGONAL	1531-102	1800x2400x24	1 pce	303
EchoMonoc® 24mm FENCE	1531-103	1800x2400x24	1 pce	303
EchoMonoc® 24mm FISHBONE	1531-104	1800x2400x24	1 pce	303
EchoMonoc® 24mm FLOW	1531-105	1800x2400x24	1 pce	303
EchoMonoc® 24mm FRAGMENTS	1531-106	1800x2400x24	1 pce	303
EchoMonoc® 24mm KINGSCROSS	1531-107	1800x2400x24	1 pce	303
EchoMonoc® 24mm LEAVES	1531-108	1800x2400x24	1 pce	303
EchoMonoc® 24mm SEAWEED	1531-109	1800x2400x24	1 pce	303
EchoMonoc® 24mm SPHERE	1531-110	1800x2400x24	1 pce	303
EchoMonoc® 24mm STREAMS	1531-111	1800x2400x24	1 pce	303
EchoMonoc® 24mm VERTIGO	1531-112	1800x2400x24	1 pce	303
EchoMonoc® 24mm WAVE	1531-113	1800x2400x24	1 pce	303
EchoMonoc® 24mm WOVEN	1531-115	1800x2400x24	1 pce	303
EchoMonoc® 24mm ZIGZAG	1531-114	1800x2400x24	1 pce	303

ECHOMONOC® 24MM  
BALLOON

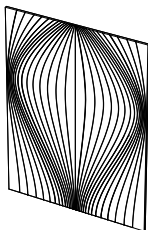

ECHOMONOC® 24MM  
CODE

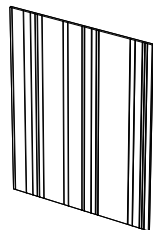

ECHOMONOC® 24MM  
DIAGONAL

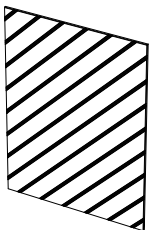

ECHOMONOC® 24MM  
FENCE

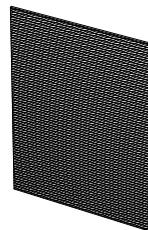

ECHOMONOC® 24MM  
FISHBONE

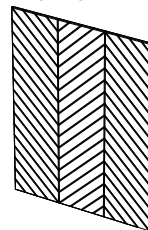

ECHOMONOC® 24MM  
FLOW

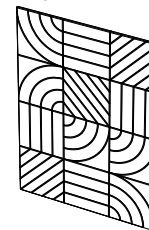

ECHOMONOC® 24MM  
FRAGMENTS

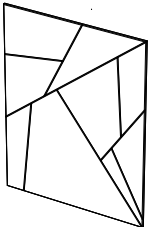

ECHOMONOC® 24MM  
KINGSCROSS

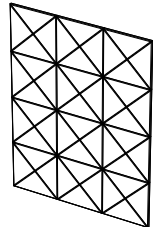

ECHOMONOC® 24MM  
LEAVES



ECHOMONOC® 24MM  
SEAWEED

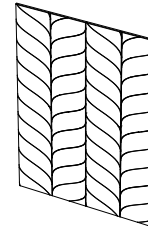

ECHOMONOC® 24MM  
SPHERE

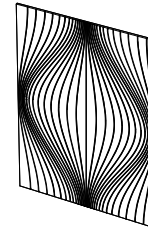

ECHOMONOC® 24MM  
STREAMS

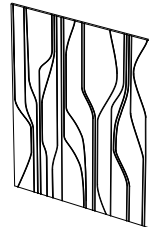

ECHOMONOC® 24MM  
VERTIGO

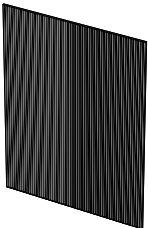

ECHOMONOC® 24MM  
WAVE

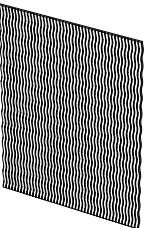

ECHOMONOC® 24MM  
WOVEN



ECHOMONOC® 24MM  
ZIGZAG

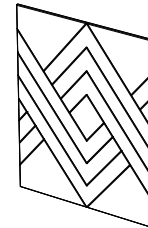

## ECHOCOUSTIC® ACCENT

EchoCoustic® with V-shaped cuts makes the white high-performance absorption layer visible. This creates special line designs and thus accentuates in the truest sense of the word. The special EchoCoustic® absorber is the ideal material for direct application to walls or ceilings without spacing or substructure. With its three layers, it achieves an excellent absorption coefficient of  $\alpha_w$  0.80 and NRC 0.85 with a thickness of only 25mm. The absorber made of recycled PET is extremely robust and suitable for regular cleaning and disinfection. Installation is quick and easy with EchoGlue® contact spray adhesive.

The design of large-area acoustic walls takes on a new dimension. The high-contrast recesses allow for spectacular patterns, from existing designs to completely customised creations.





COMPANY PROFILE

MATERIAL

CEILING

LIGHTING

WALLS

PARTITIONS

FURNITURE

ADDITIONAL ITEMS

CREATE

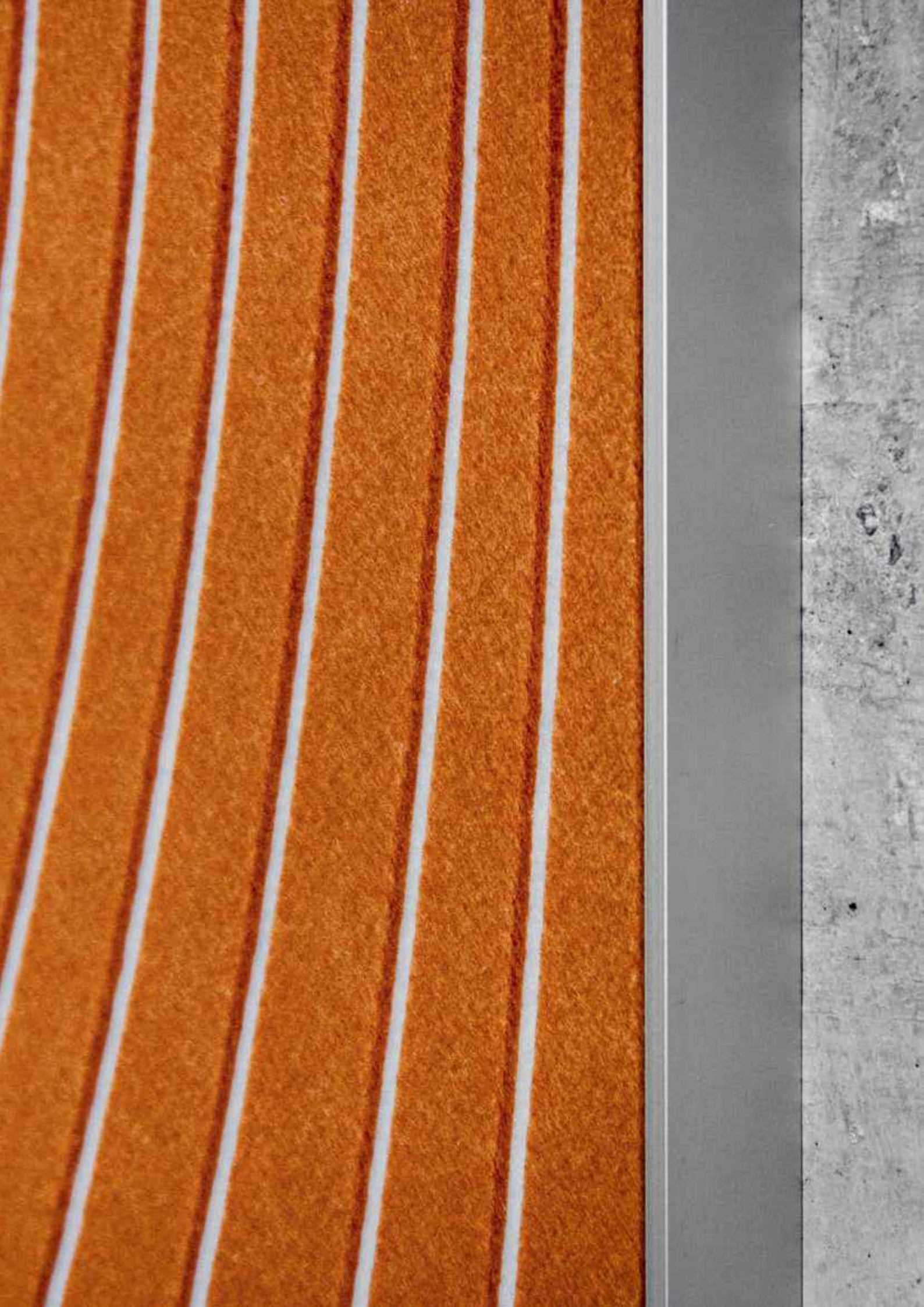

# ECHOCOUSTIC® 25MM ACCENT

Acoustic wall panels with bevelling. Installation by means of EchoGlue® spray adhesive (included).

Absorption coefficient:  $\alpha_w$  0.80, class B

You can always find the latest designs online at [www.echojazz.com/echocoustic-accent](http://www.echojazz.com/echocoustic-accent)

Discover our EchoCoustic® 25mm PROFILE edge profiles! (Page 207)



NAME	ARTICLE	W x H x D (in mm)	UNIT	PET-BOTTLES
EchoCoustic® 25mm ACCENT BALLOON LEFT	1008-100	1190x2700x25	1 Pce	177
EchoCoustic® 25mm ACCENT BALLOON RIGHT	1008-100	1190x2700x25	1 Pce	177
EchoCoustic® 25mm ACCENT CODE	1008-103	1190x2700x25	1 Pce	177
EchoCoustic® 25mm ACCENT DIAGONAL	1008-104	1190x2700x25	1 Pce	177
EchoCoustic® 25mm ACCENT FENCE	1008-102	1190x2700x25	1 Pce	177
EchoCoustic® 25mm ACCENT SPHERE	1008-101	1190x2700x25	1 Pce	177
EchoCoustic® 25mm ACCENT STREAMS	1008-107	1190x2700x25	1 Pce	177
EchoCoustic® 25mm ACCENT VERTIGO	1008-106	1190x2700x25	1 Pce	177
EchoCoustic® 25mm ACCENT WAVE	1008-105	1190x2700x25	1 Pce	177

ECHOCOUSTIC® 25MM ACCENT  
BALLOON (LEFT/RIGHT)

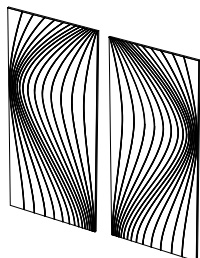

ECHOCOUSTIC® 25MM ACCENT  
CODE

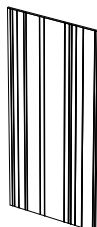

ECHOCOUSTIC® 25MM ACCENT  
DIAGONAL

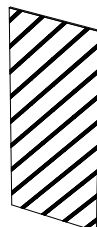

ECHOCOUSTIC® 25MM ACCENT  
FENCE



ECHOCOUSTIC® 25MM ACCENT  
SPHERE

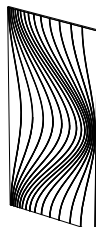

ECHOCOUSTIC® 25MM ACCENT  
STREAMS



ECHOCOUSTIC® 25MM ACCENT  
VERTIGO

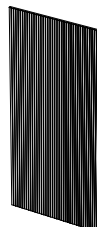

ECHOCOUSTIC® 25MM ACCENT  
WAVE

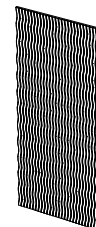



## ACOUSTIC-PARTITIONS

Partition walls with sound insulation make it easy to divide rooms and optimise room acoustics in offices as well as in all other living and working environments. Available as mobile or permanently installed elements, they offer countless possibilities for room design.



## ECHOCURTAIN®

As an acoustic room divider in an open-space office, the EchoCurtain® in 12mm and 24mm material thicknesses offers a flexible and transparent solution. The EchoCurtain® is suspended directly from the ceiling by means of a steel cable suspension, or optionally with a rail system. The acoustic room divider hangs seemingly floating in the room and provides a specific touch with cut-out perforations.

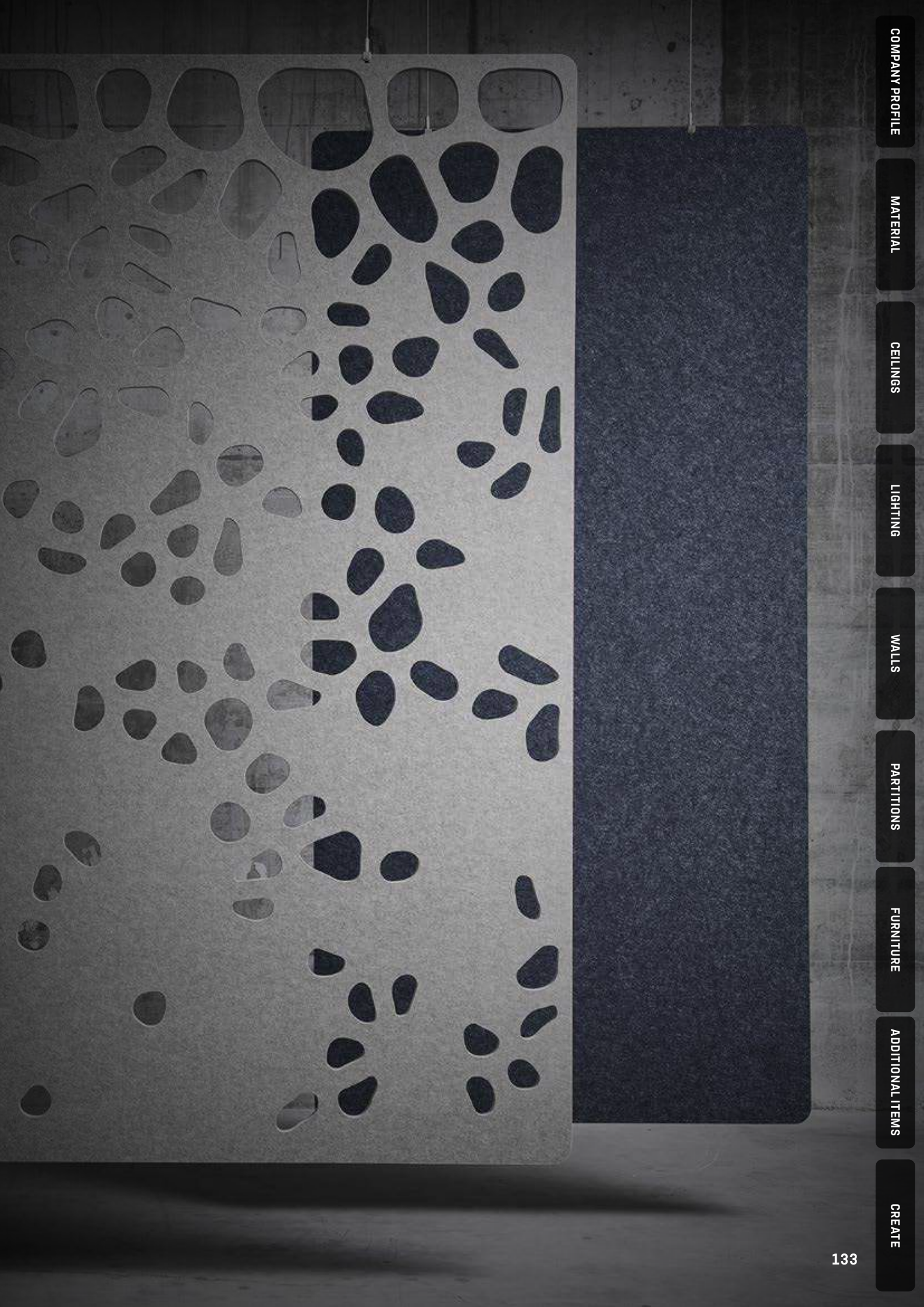

COMPANY PROFILE

MATERIAL

CEILING

LIGHTING

WALLS

PARTITIONS

FURNITURE

ADDITIONAL ITEMS

CREATE

# ECHOCURTAIN® 12MM

Suspended acoustic screens incl. suspension system

Absorption coefficient:  $\alpha_w$  0.90, class A

Special dimensions and designs on request

This product is available with our perforations. ([Page 241](#))

NAME	ARTICLE	W x H x D (in mm)	UNIT	PET-BOTTLES
EchoCurtain® 12mm PLAIN	1241	1200x2800x12	1 pce	168
EchoCurtain® 12mm PERFORATED	1465	1200x2800x12	1 pce	168

ECHOCURTAIN® 12MM  
PLAIN

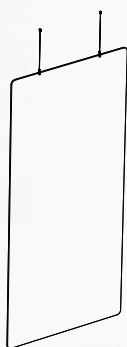

# ECHOCURTAIN® 24MM

Suspended acoustic screens incl. suspension system

Absorption coefficient:  $\alpha_w$  1.00, class A

Special dimensions and designs on request

This product is available with our perforations. ([Page 241](#))

NAME	ARTICLE	W x H x D (in mm)	UNIT	PET-BOTTLES
EchoCurtain® 24mm PLAIN	1242	1800x2400x24	1 pce	303
EchoCurtain® 24mm PERFORATED	1464	1800x2400x24	1 pce	303

**ECHOCURTAIN® 24MM  
PLAIN**

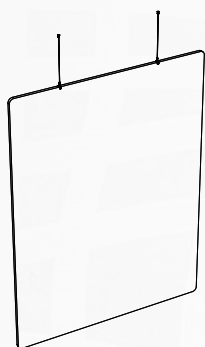



## ECHOTORRENT®

The EchoTorrent® acoustic partitions were specially developed for high rooms with a ceiling height of up to four metres, whereby the high-performance acoustic absorbers can be positioned at individual heights. The clamping elements are firmly screwed to the ceiling and floor. The acoustic elements are clamped to the connecting cables.

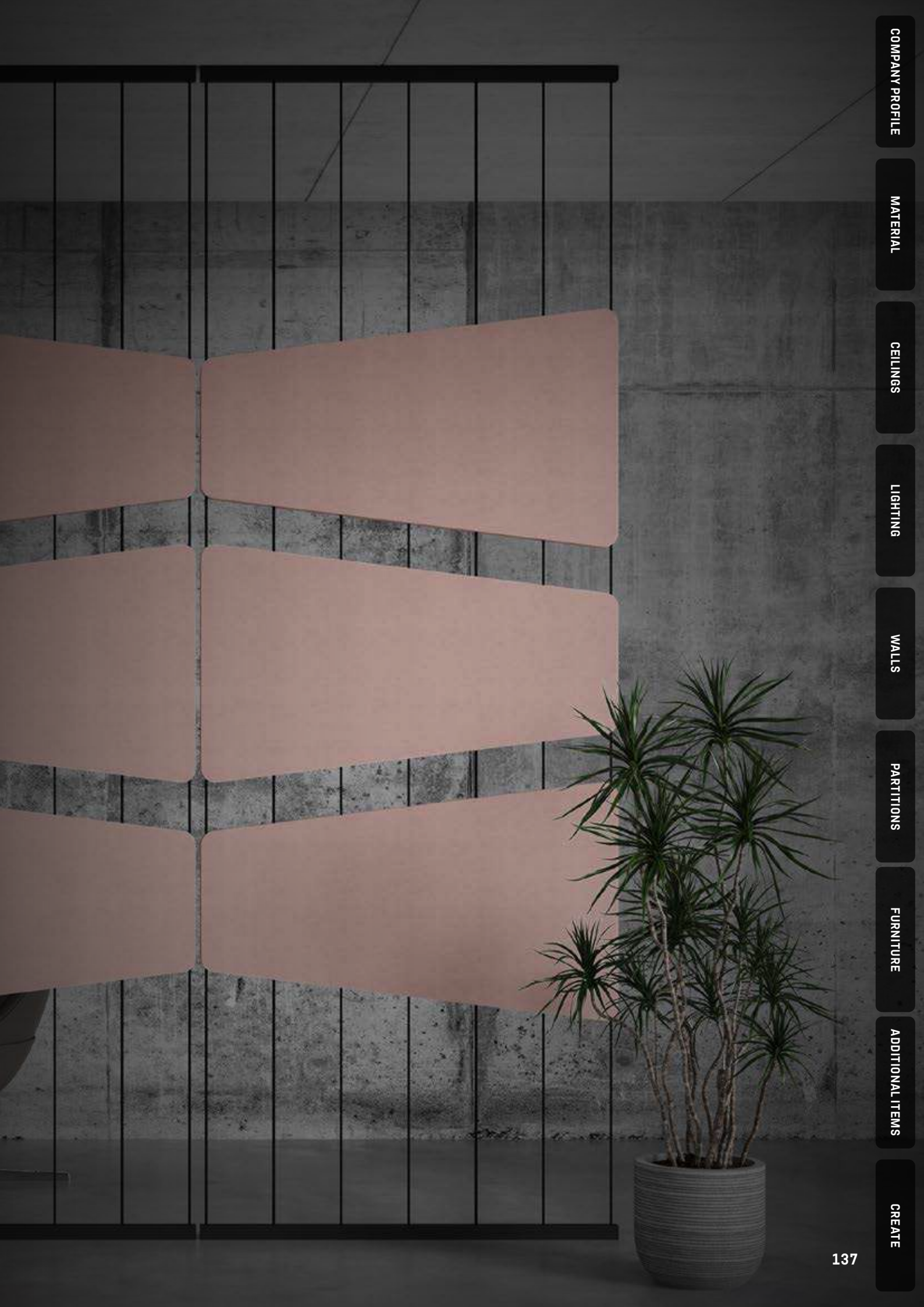

COMPANY PROFILE

MATERIAL

CEILING

LIGHTING

WALLS

PARTITIONS

FURNITURE

ADDITIONAL ITEMS

CREATE

# ECHOTORRENT® 12MM

Hanging acoustic screens incl. suspension system

Absorption coefficient:  $\alpha_w$  0.90, class A

Special dimensions and designs on request

NAME	ARTICLE	W x H x D (in mm)	UNIT	PET-BOTTLES
EchoTorrent® 12mm OBLONG	1721	1200x2300-4000x34mm	1 Pce	149
EchoTorrent® 12mm BUTTERFLY	1722	1200x2300-4000x34mm	1 Pce	158
EchoTorrent® 12mm DIAGONAL	1723	1200x2300-4000x34mm	1 Pce	162
EchoTorrent® 12mm DOT	1724	1200x2300-4000x34mm	1 Pce	117
EchoTorrent® 12mm DROP A	1725	1200x2300-4000x34mm	1 Pce	114
EchoTorrent® 12mm DROP B	1726	1200x2300-4000x34mm	1 Pce	114
EchoTorrent® 12mm ELLIPSE A	1727	1200x2300-4000x34mm	1 Pce	128
EchoTorrent® 12mm ELLIPSE B	1728	1200x2300-4000x34mm	1 Pce	128
EchoTorrent® 12mm HEXAGON A	1729	1200x2300-4000x34mm	1 Pce	118
EchoTorrent® 12mm HEXAGON B	1730	1200x2300-4000x34mm	1 Pce	118
EchoTorrent® 12mm PLANK	1731	1200x2300-4000x34mm	1 Pce	140
EchoTorrent® 12mm TILT	1732	1200x2300-4000x34mm	1 Pce	106
EchoTorrent® 12mm TAPER	1733	1200x2300-4000x34mm	1 Pce	130

ECHOTORRENT®  
12MM OBLONG

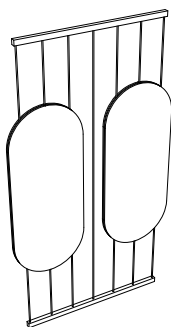

ECHOTORRENT®  
12MM BUTTERFLY

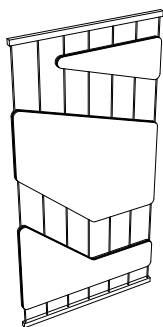

ECHOTORRENT®  
12MM DIAGONAL

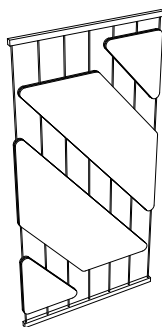

ECHOTORRENT®  
12MM DOT

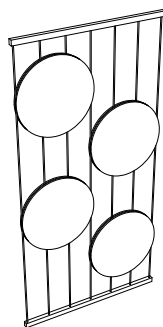

ECHOTORRENT®  
12MM DROP A

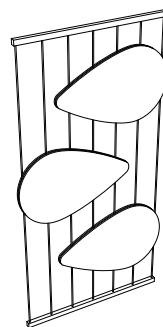

ECHOTORRENT®  
12MM DROP B

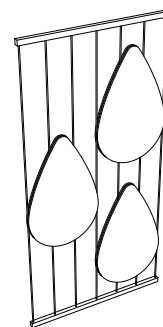

ECHOTORRENT®  
12MM ELLIPSE A

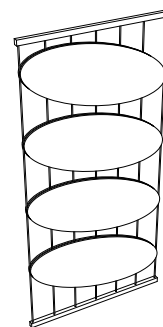

ECHOTORRENT®  
12MM ELLIPSE B

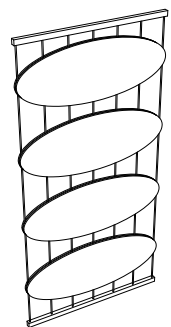

ECHOTORRENT®  
12MM HEXAGON A

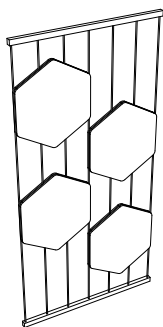

ECHOTORRENT®  
12MM HEXAGON B

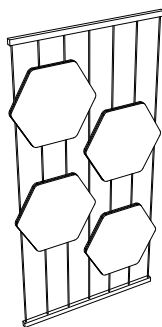

ECHOTORRENT®  
12MM PLANK

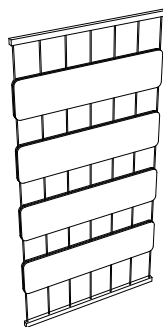

ECHOTORRENT®  
12MM TILT

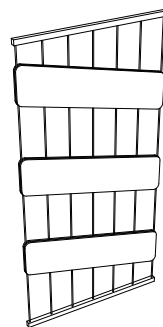

ECHOTORRENT®  
12MM TAPER

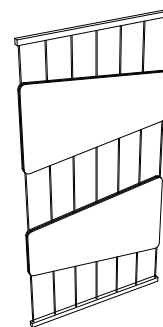



COMPANY PROFILE

MATERIAL

CEILING

LIGHTING

WALLS

PARTITIONS

FURNITURE

ADDITIONAL ITEMS

CREATE



# ECHOTORRENT® 24MM

Hanging acoustic screens incl. suspension system

Absorption coefficient:  $\alpha_w$  1.00, class A

Special dimensions and designs on request

NAME	ARTICLE	W x H x D (in mm)	UNIT	PET-BOTTLES
EchoTorrent® 24mm OBLONG	1701	1200x2300-4000x57mm	1 Pce	296
EchoTorrent® 24mm BUTTERFLY	1702	1200x2300-4000x57mm	1 Pce	303
EchoTorrent® 24mm DIAGONAL	1703	1200x2300-4000x57mm	1 Pce	311
EchoTorrent® 24mm DOT	1704	1200x2300-4000x57mm	1 Pce	215
EchoTorrent® 24mm DROP A	1705	1200x2300-4000x57mm	1 Pce	184
EchoTorrent® 24mm DROP B	1706	1200x2300-4000x57mm	1 Pce	184
EchoTorrent® 24mm ELLIPSE A	1707	1200x2300-4000x57mm	1 Pce	226
EchoTorrent® 24mm ELLIPSE B	1708	1200x2300-4000x57mm	1 Pce	226
EchoTorrent® 24mm HEXAGON A	1709	1200x2300-4000x57mm	1 Pce	242
EchoTorrent® 24mm HEXAGON B	1710	1200x2300-4000x57mm	1 Pce	242
EchoTorrent® 24mm PLANK	1711	1200x2300-4000x57mm	1 Pce	316
EchoTorrent® 24mm TILT	1712	1200x2300-4000x57mm	1 Pce	265
EchoTorrent® 24mm TAPER	1713	1200x2300-4000x57mm	1 Pce	292

ECHOTORRENT®  
24MM OBLONG

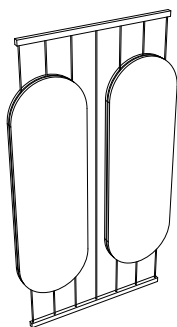

ECHOTORRENT®  
24MM BUTTERFLY

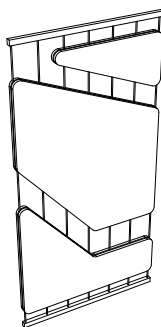

ECHOTORRENT®  
24MM DIAGONAL

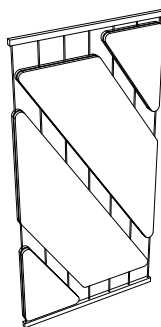

ECHOTORRENT®  
24MM DOT

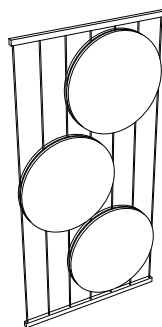

ECHOTORRENT®  
24MM DROP A

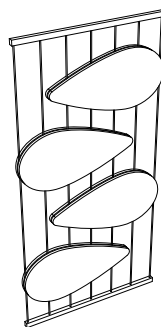

ECHOTORRENT®  
24MM DROP B

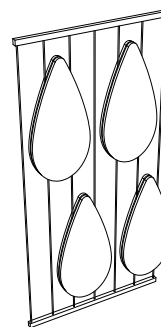

ECHOTORRENT®  
24MM ELLIPSE A

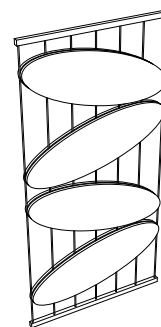

ECHOTORRENT®  
24MM ELLIPSE B

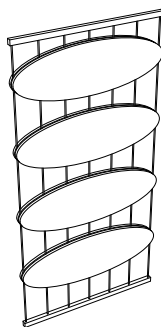

ECHOTORRENT®  
24MM HEXAGON A

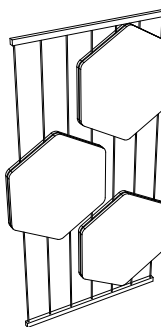

ECHOTORRENT®  
24MM HEXAGON B

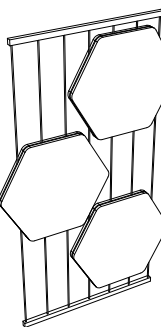

ECHOTORRENT®  
24MM PLANK

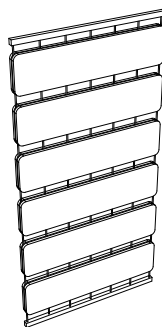

ECHOTORRENT®  
24MM TILT

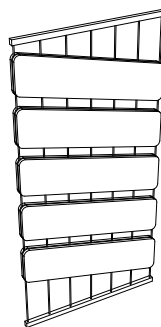

ECHOTORRENT®  
24MM TAPER

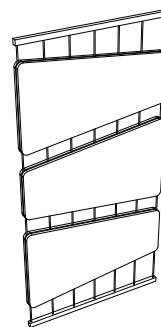



## ECHOCOVE® ECO

Thanks to a plug-in system, the EchoCove® ECO and PALING movable walls offer endless combination possibilities. They can be assembled and reconfigured without tools. The high density of the lightweight material of these acoustic partitions allows for a frameless construction. The perforations create the desired degree of permeability and attention with sophisticated details.



COMPANY PROFILE

MATERIAL

CEILING

LIGHTING

WALLS

PARTITIONS

FURNITURE

ADDITIONAL ITEMS

CREATE



# ECHOCOVE® 24MM ECO 79

Frameless acoustic partition for installation on the floor (tool-free) excl. EchoCove® JOINER connectors.

Absorption coefficient:  $\alpha_w$  1.00, class A

Special dimensions and designs on request.

Please specify the joiner type when ordering. (Page 215)

This product is available with our perforations. (Page 241)

NAME	ARTICLE	W x H x D (in mm)	UNIT	PET-BOTTLES
EchoCove® 24mm ECO END 79 S PLAIN	1206	790x1180x24	1 Pce	68
EchoCove® 24mm ECO END 79 S PERFORATED	1477	790x1180x24	1 Pce	68
EchoCove® 24mm ECO END 79 M PLAIN	1207	790x1420x24	1 Pce	79
EchoCove® 24mm ECO END 79 M PERFORATED	1478	790x1420x24	1 Pce	79
EchoCove® 24mm ECO END 79 L PLAIN	1208	790x1800x24	1 Pce	101
EchoCove® 24mm ECO END 79 L PERFORATED	1479	790x1800x24	1 Pce	101
EchoCove® 24mm ECO STEP END 79 M PLAIN	1237	790x1420x24	1 Pce	79
EchoCove® 24mm ECO STEP END 79 M PERFORATED	1480	790x1420x24	1 Pce	79
EchoCove® 24mm ECO STEP END 79 L PLAIN	1238	790x1800x24	1 Pce	101
EchoCove® 24mm ECO STEP END 79 L PERFORATED	1481	790x1800x24	1 Pce	101
EchoCove® 24mm ECO MID 79 S PLAIN	1213	790x1180x24	1 Pce	68
EchoCove® 24mm ECO MID 79 S PERFORATED	1482	790x1180x24	1 Pce	68
EchoCove® 24mm ECO MID 79 M PLAIN	1214	790x1420x24	1 Pce	79
EchoCove® 24mm ECO MID 79 M PERFORATED	1483	790x1420x24	1 Pce	79
EchoCove® 24mm ECO MID 79 L PLAIN	1215	790x1800x24	1 Pce	101
EchoCove® 24mm ECO MID 79 L PERFORATED	1484	790x1800x24	1 Pce	101
EchoCove® 24mm ECO STEP MID 79 M PLAIN	1239	790x1420x24	1 Pce	79
EchoCove® 24mm ECO STEP MID 79 M PERFORATED	1485	790x1420x24	1 Pce	79
EchoCove® 24mm ECO STEP MID 79 L PLAIN	1240	790x1800x24	1 Pce	101
EchoCove® 24mm ECO STEP MID 79 L PERFORATED	1486	790x1800x24	1 Pce	101

ECHOCOVE® 24MM ECO  
END 79 S



ECHOCOVE® 24MM ECO  
MID 79 S



ECHOCOVE® 24MM ECO  
END 79 M



ECHOCOVE® 24MM ECO  
MID 79 M

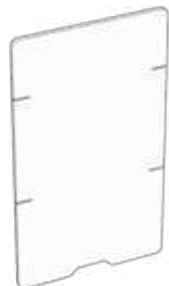

ECHOCOVE® 24MM ECO  
END 79 L



ECHOCOVE® 24MM ECO  
MID 79 L

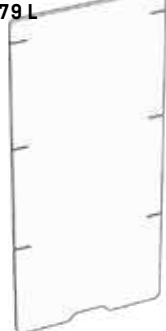

ECHOCOVE® 24MM ECO  
STEP END 79 M



ECHOCOVE® 24MM ECO  
STEP MID 79 M



ECHOCOVE® 24MM ECO  
STEP END 79 L



ECHOCOVE® 24MM ECO  
STEP MID 79 L



# ECHOCOVE® 24MM ECO 159

Frameless acoustic partition for installation on the floor (tool-free) excl. EchoCove® JOINER connectors.

Absorption coefficient:  $\alpha_w$  1.00, class A

Special dimensions and designs on request.

Please specify the joiner type when ordering. [\(Page 215\)](#)

This product is available with our perforations. [\(Page 241\)](#)

NAME	ARTICLE	W x H x D (in mm)	UNIT	PET-BOTTLES
EchoCove® 24mm ECO MID 159 S PLAIN	1216	1585x1180x24	1 Pce	137
EchoCove® 24mm ECO MID 159 S PERFORATED	1487	1585x1180x24	1 Pce	137
EchoCove® 24mm ECO MID 159 M PLAIN	1217	1585x1420x24	1 Pce	159
EchoCove® 24mm ECO MID 159 M PERFORATED	1488	1585x1420x24	1 Pce	159
EchoCove® 24mm ECO MID 159 L PLAIN	1218	1585x1800x24	1 Pce	202
EchoCove® 24mm ECO MID 159 L PERFORATED	1489	1585x1800x24	1 Pce	202

**ECHOCOVE® 24MM ECO  
MID 159 S**

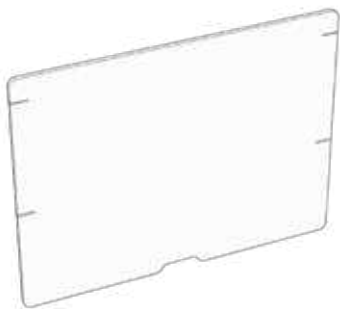

**ECHOCOVE® 24MM ECO  
MID 159 M**

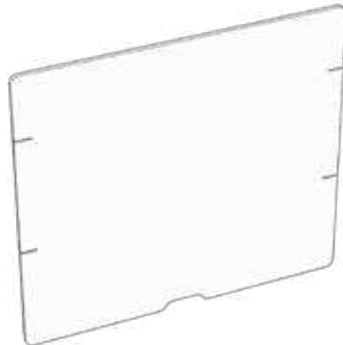

**ECHOCOVE® 24MM ECO  
MID 159 L**

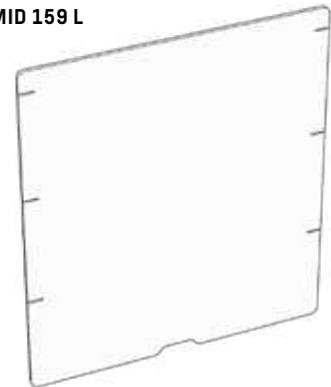

# ECHOCOVE® 24MM ECO 180

Frameless acoustic partition for installation on the floor (tool-free) excl. EchoCove® JOINER connectors.

Absorption coefficient:  $\alpha_w$  1.00, class A

Special dimensions and designs on request.

Please specify the joiner type when ordering. [\(Page 215\)](#)

This product is available with our perforations. [\(Page 241\)](#)

NAME	ARTICLE	W x H x D (in mm)	UNIT	PET-BOTTLES
EchoCove® 24mm ECO MID 180 S PLAIN	1219	1800x1180x24	1 Pce	156
EchoCove® 24mm ECO MID 180 S PERFORATED	1490	1800x1180x24	1 Pce	156
EchoCove® 24mm ECO MID 180 M PLAIN	1220	1800x1420x24	1 Pce	181
EchoCove® 24mm ECO MID 180 M PERFORATED	1491	1800x1420x24	1 Pce	181
EchoCove® 24mm ECO MID 180 L PLAIN	1221	1800x1800x24	1 Pce	230
EchoCove® 24mm ECO MID 180 L PERFORATED	1492	1800x1800x24	1 Pce	230

ECHOCOVE® 24MM ECO  
MID 180 S

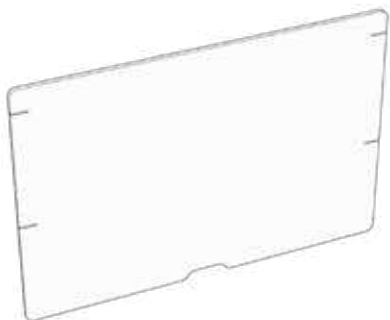

ECHOCOVE® 24MM ECO  
MID 180 M

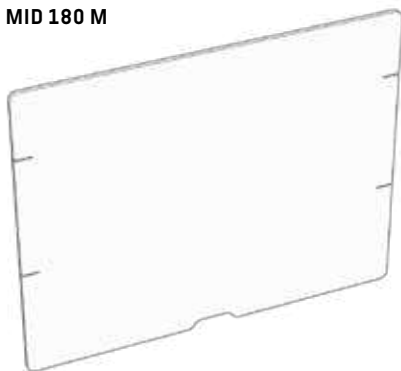

ECHOCOVE® 24MM ECO  
MID 180 L

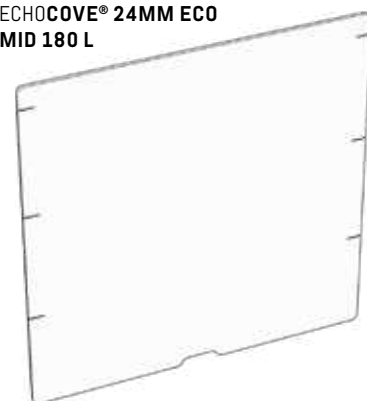

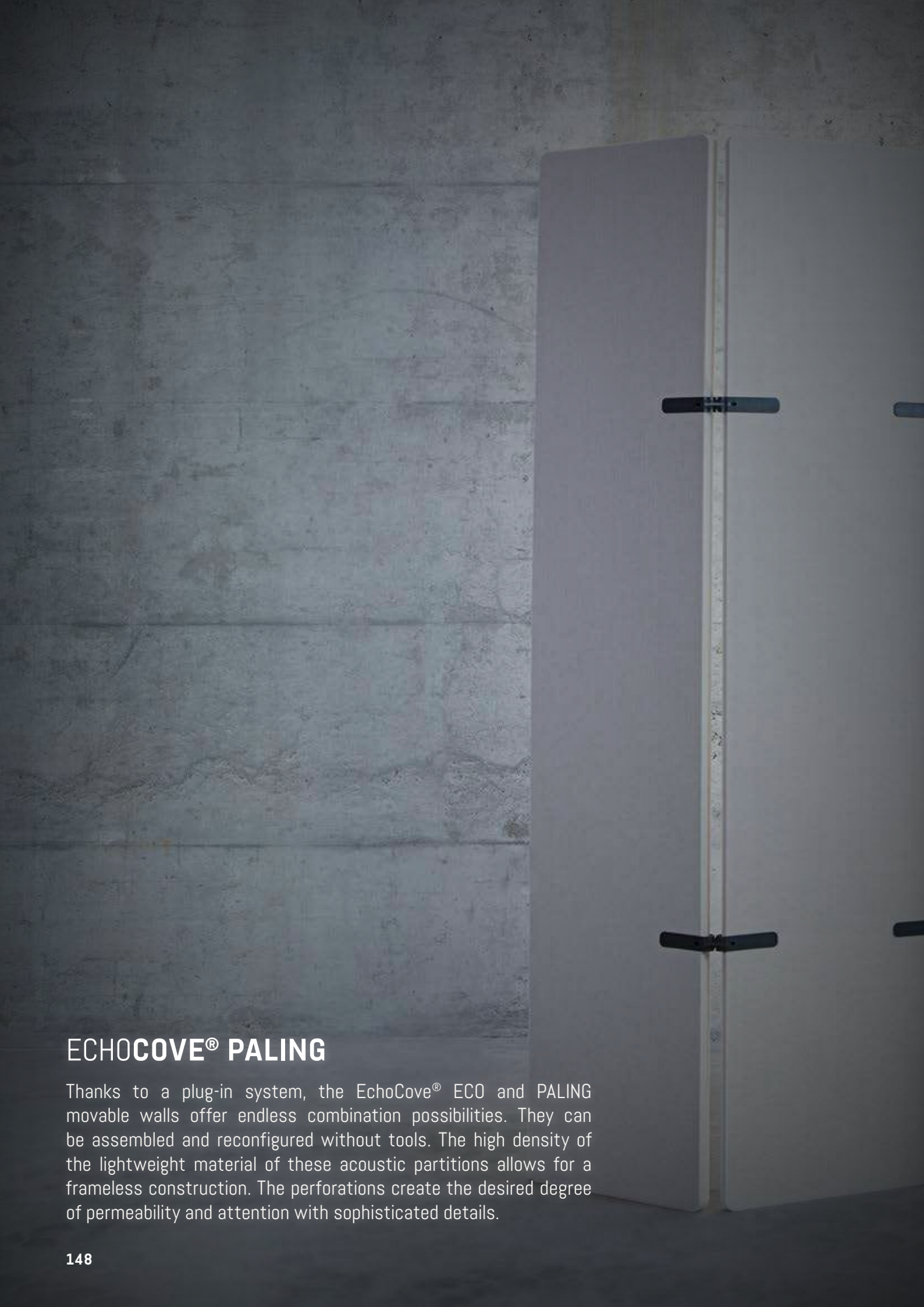

## ECHOCOVE® PALING

Thanks to a plug-in system, the EchoCove® ECO and PALING movable walls offer endless combination possibilities. They can be assembled and reconfigured without tools. The high density of the lightweight material of these acoustic partitions allows for a frameless construction. The perforations create the desired degree of permeability and attention with sophisticated details.



COMPANY PROFILE

MATERIAL

CEILING

LIGHTING

WALLS

PARTITIONS

FURNITURE

ADDITIONAL ITEMS

CREATE



# ECHOCOVE® 24MM PALING

Frameless folding acoustic wall incl. EchoCove® JOINER PIVOT.

Absorption coefficient:  $\alpha_w$  1.00, class A

Special dimensions and designs on request

This product is available with our perforations. ([Page 241](#))

NAME	ARTICLE	W x H x D (in mm)	UNIT	PET-BOTTLES
EchoCove® 24mm PALING PLAIN	1228	2125x1800x230	1 Pce	297
EchoCove® 24mm PALING PERFORATED	1493	2125x1800x230	1 Pce	297

ECHOCOVE® 24MM  
PALING

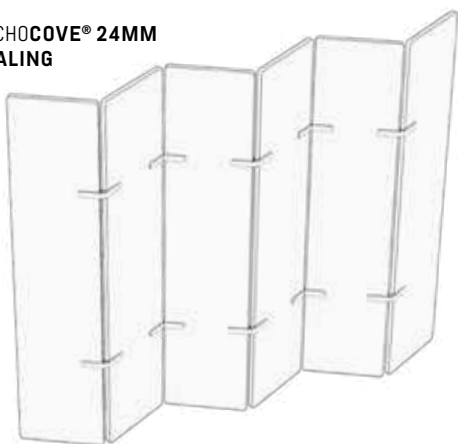



## ECHOCOVE® STAND

EchoCove® STAND offers a free-standing, frameless solution as a room divider or workstation partition. The panel is offered in four heights and two widths with maximum dimensions of 180cm by 180cm. The high-quality steel base ensures a secure stand. Assembly is tool-free.



COMPANY PROFILE

MATERIAL

CEILING

LIGHTING

WALLS

PARTITIONS

FURNITURE

ADDITIONAL ITEMS

CREATE



# ECHOCOVE® 24MM STAND

Frameless acoustic partition wall for installation on the floor, team tables or storage furniture incl. high-quality base, deep matt powder-coated (no tools required).

Absorption coefficient:  $\alpha_w$  1.00, class A

Colour of base: Black RAL9005

This product is available with our perforations. (Page 241)

<sup>1</sup>The XL product variations are available with our three bases FULL, SLIM and ARCH. (Page 225)

<sup>2</sup>Our SILHOUETTE designs are only available in size 180 XL variations. (Page 245)

NAME	ARTICLE	W x H x D (in mm)	UNIT	PET-BOTTLES
EchoCove® 24mm STAND 160 S PLAIN	1229	1600x600x200	1 Pce	70
EchoCove® 24mm STAND 160 S PERFORATED	1494	1600x600x200	1 Pce	58
EchoCove® 24mm STAND 160 M PLAIN	1230	1600x1215x400	1 Pce	131
EchoCove® 24mm STAND 160 M PERFORATED	1495	1600x1215x400	1 Pce	108
EchoCove® 24mm STAND 160 L PLAIN	1231	1600x1455x400	1 Pce	161
EchoCove® 24mm STAND 160 L PERFORATED	1496	1600x1455x400	1 Pce	132
EchoCove® 24mm STAND 160 XL PLAIN <sup>1</sup>	1232	1600x1835x400/413/353	1 Pce	208
EchoCove® 24mm STAND 160 XL PERFORATED <sup>1</sup>	1497	1600x1835x400/413/353	1 Pce	171
EchoCove® 24mm STAND 180 S PLAIN	1233	1800x600x200	1 Pce	79
EchoCove® 24mm STAND 180 S PERFORATED	1498	1800x600x200	1 Pce	65
EchoCove® 24mm STAND 180 M PLAIN	1234	1800x1215x400	1 Pce	149
EchoCove® 24mm STAND 180 M PERFORATED	1499	1800x1215x400	1 Pce	122
EchoCove® 24mm STAND 180 L PLAIN	1235	1800x1455x400	1 Pce	182
EchoCove® 24mm STAND 180 L PERFORATED	1500	1800x1455x400	1 Pce	150
EchoCove® 24mm STAND 180 XL PLAIN <sup>1</sup>	1236	1800x1835x400/413/353	1 Pce	235
EchoCove® 24mm STAND 180 XL PERFORATED <sup>1</sup>	1501	1800x1835x400/413/353	1 Pce	193
EchoCove® 24mm STAND 180 XL SILHOUETTE <sup>1,2</sup>	1737	1800x1835x400/413/353	1 Stk	208

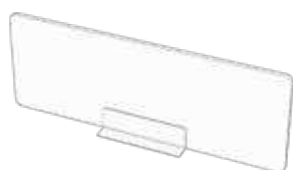

ECHOCOVE® 24MM STAND  
160 S

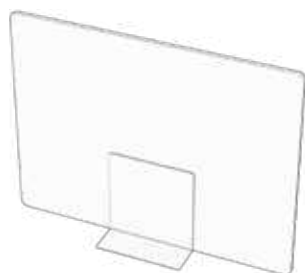

ECHOCOVE® 24MM STAND  
160 M

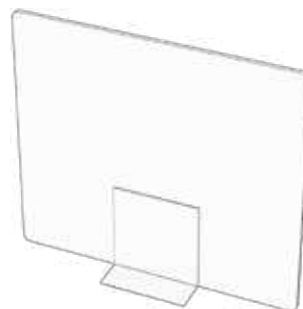

ECHOCOVE® 24MM STAND  
160 L

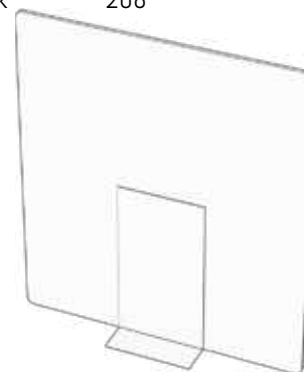

ECHOCOVE® 24MM STAND  
160 XL

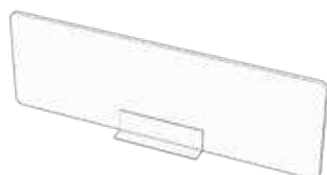

ECHOCOVE® 24MM STAND  
180 S

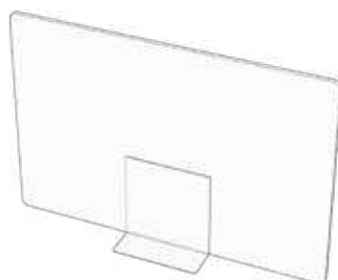

ECHOCOVE® 24MM STAND  
180 M

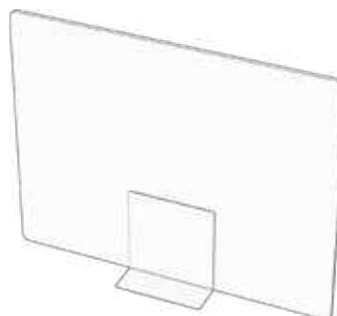

ECHOCOVE® 24MM STAND  
180 L

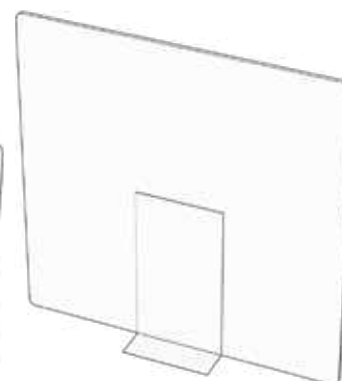

ECHOCOVE® 24MM STAND  
180 XL

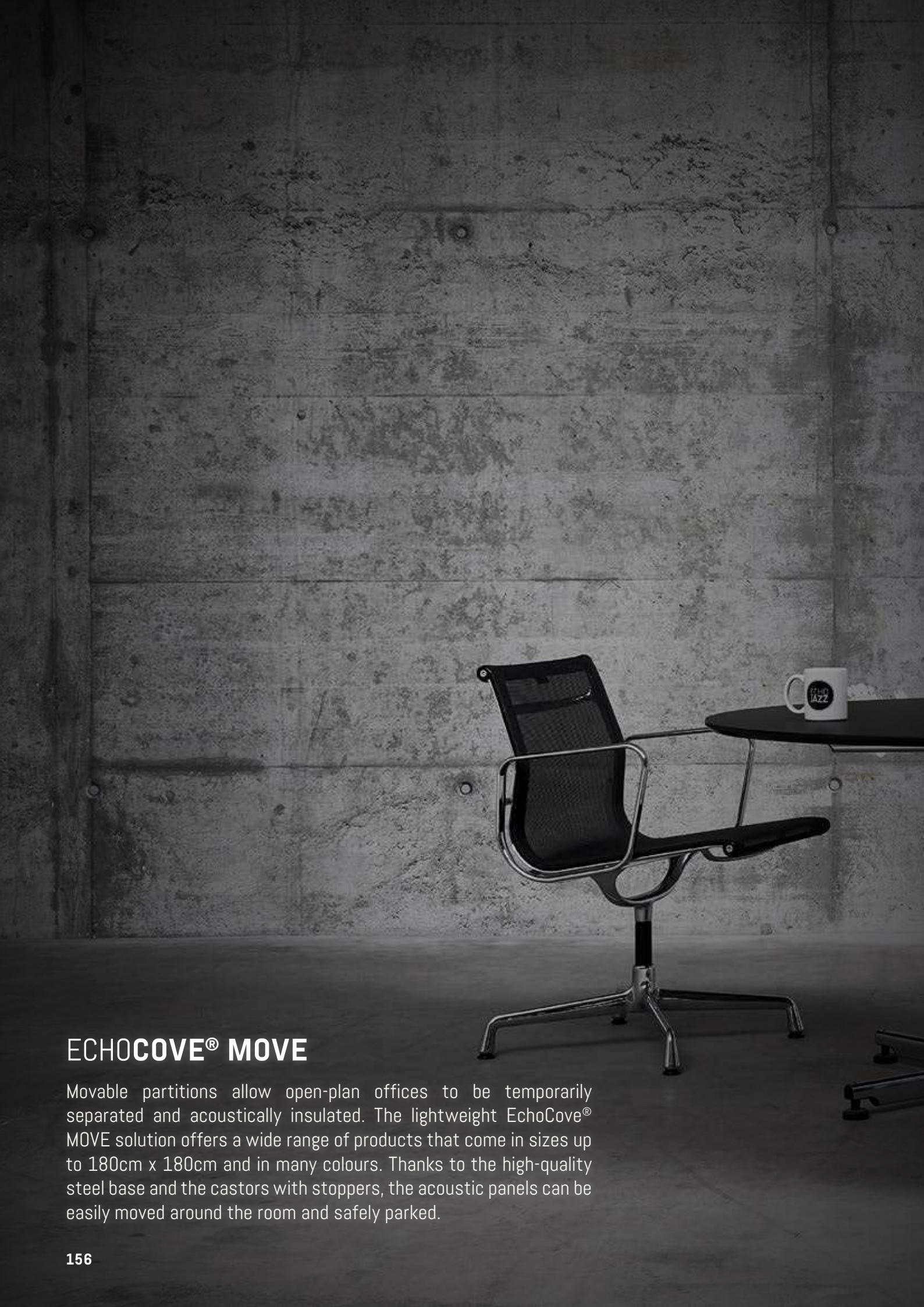

## ECHOCOVE® MOVE

Movable partitions allow open-plan offices to be temporarily separated and acoustically insulated. The lightweight EchoCove® MOVE solution offers a wide range of products that come in sizes up to 180cm x 180cm and in many colours. Thanks to the high-quality steel base and the castors with stoppers, the acoustic panels can be easily moved around the room and safely parked.



COMPANY PROFILE

MATERIAL

CEILING

LIGHTING

WALLS

PARTITIONS

FURNITURE

ADDITIONAL ITEMS

CREATE

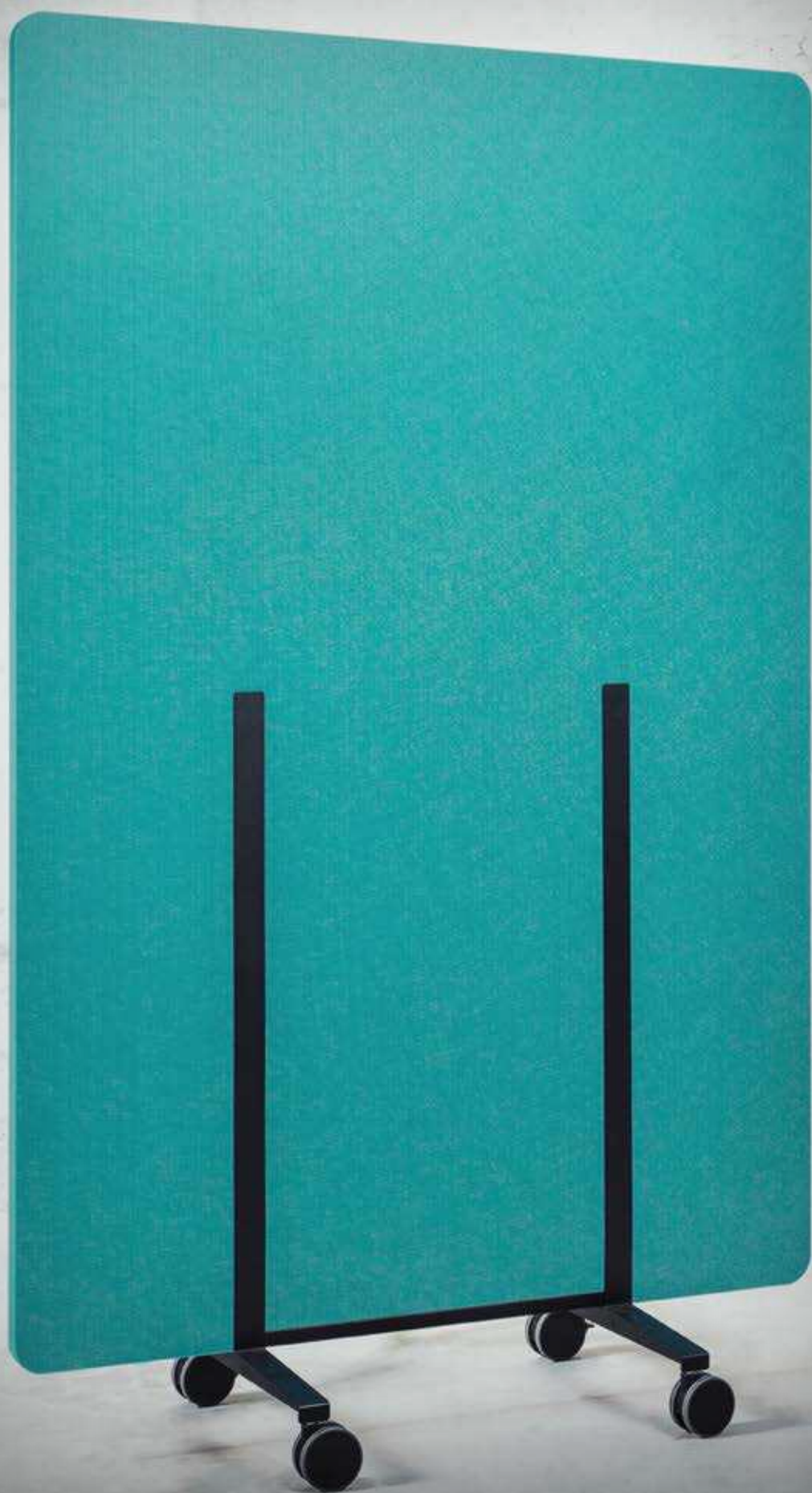

# ECHOCOVE® 24MM MOVE

Frameless acoustic movable wall with high-quality base frame with castors incl. stoppers, deep matt powder-coated (no tools required).

Absorption coefficient:  $\alpha_w$  1.00, class A

Colour of base: Black RAL9005

This product is available with our perforations. ([Page 241](#))

NAME	ARTICLE	W x H x D (in mm)	UNIT	PET-BOTTLES
EchoCove® 24mm MOVE LOW S PLAIN	1222	1180x1420x430	1 Pce	119
EchoCove® 24mm MOVE LOW S PERFORATED	1502	1180x1420x430	1 Pce	119
EchoCove® 24mm MOVE LOW M PLAIN	1224	1600x1420x430	1 Pce	161
EchoCove® 24mm MOVE LOW M PERFORATED	1503	1600x1420x430	1 Pce	161
EchoCove® 24mm MOVE LOW L PLAIN	1226	1800x1420x430	1 Pce	181
EchoCove® 24mm MOVE LOW L PERFORATED	1504	1800x1420x430	1 Pce	181
EchoCove® 24mm MOVE HIGH S PLAIN	1223	1180x1800x430	1 Pce	150
EchoCove® 24mm MOVE HIGH S PERFORATED	1505	1180x1800x430	1 Pce	150
EchoCove® 24mm MOVE HIGH M PLAIN	1225	1600x1800x430	1 Pce	204
EchoCove® 24mm MOVE HIGH M PERFORATED	1506	1600x1800x430	1 Pce	204
EchoCove® 24mm MOVE HIGH L PLAIN	1227	1800x1800x430	1 Pce	230
EchoCove® 24mm MOVE HIGH L PERFORATED	1507	1800x1800x430	1 Pce	230

ECHOCOVE® 24MM MOVE  
LOW S

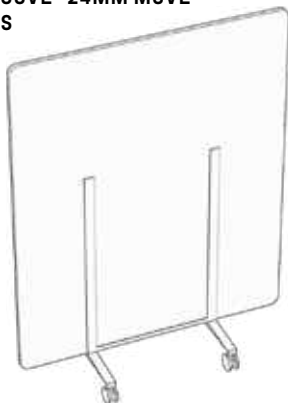

ECHOCOVE® 24MM MOVE  
LOW M

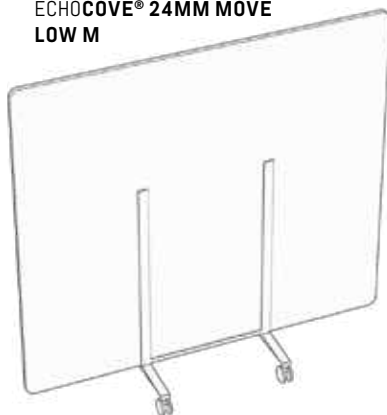

ECHOCOVE® 24MM MOVE  
LOW L

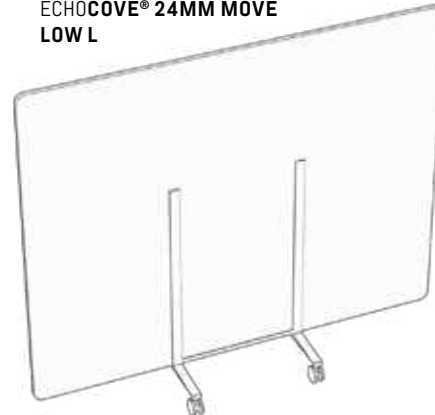

ECHOCOVE® 24MM MOVE  
HIGH S

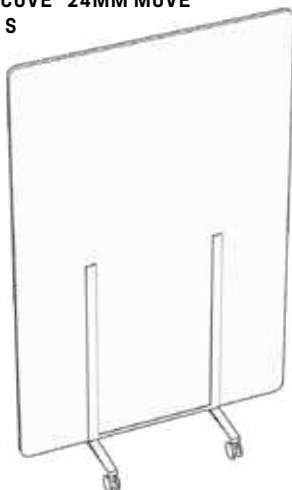

ECHOCOVE® 24MM MOVE  
HIGH M

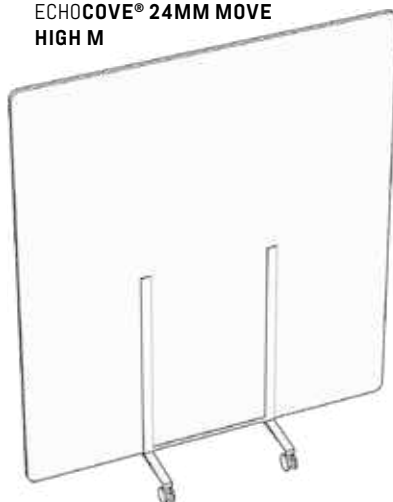

ECHOCOVE® 24MM MOVE  
HIGH L

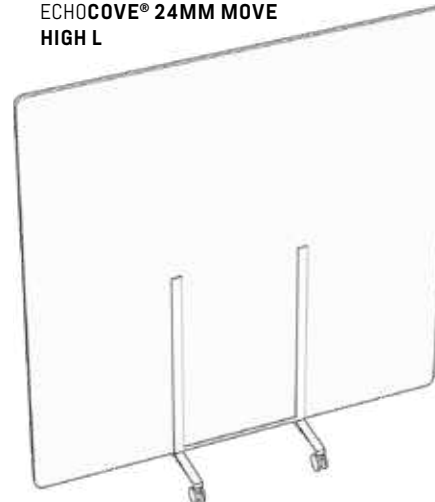



## ECHOCOVE® DESK

EchoCove® DESK separates workstations visually and acoustically. The standard adapters allow mounting on table tops from 16mm to 75mm thickness. Installation is quick and easy.



COMPANY PROFILE

MATERIAL

CEILING

LIGHTING

WALLS

PARTITIONS

FURNITURE

ADDITIONAL ITEMS

CREATE



# ECHOCOVE® 24MM DESK ONE

Frameless acoustic wall incl. high-quality table adapter, deep matt powder-coated.

Absorption coefficient: *aw* 1.00, class A

Please specify the table adapter type when ordering. (Page 217)

This product is available with our perforations. (Page 241)

NAME	ARTICLE	W x H x D (in mm)	UNIT	PET-BOTTLES
EchoCove® 24mm DESK ONE 470 S PLAIN	1188	1180x470x24	1 Pce	41
EchoCove® 24mm DESK ONE 470 S PERFORATED	1511	1180x470x24	1 Pce	33
EchoCove® 24mm DESK ONE 470 M PLAIN	1190	1400x470x24	1 Pce	48
EchoCove® 24mm DESK ONE 470 M PERFORATED	1513	1400x470x24	1 Pce	40
EchoCove® 24mm DESK ONE 470 L PLAIN	1192	1600x470x24	1 Pce	56
EchoCove® 24mm DESK ONE 470 L PERFORATED	1514	1600x470x24	1 Pce	46
EchoCove® 24mm DESK ONE 470 XL PLAIN	1194	1800x470x24	1 Pce	63
EchoCove® 24mm DESK ONE 470 XL PERFORATED	1515	1800x470x24	1 Pce	51
EchoCove® 24mm DESK ONE 590 S PLAIN	1189	1180x590x24	1 Pce	51
EchoCove® 24mm DESK ONE 590 S PERFORATED	1512	1180x590x24	1 Pce	42
EchoCove® 24mm DESK ONE 590 M PLAIN	1191	1400x590x24	1 Pce	61
EchoCove® 24mm DESK ONE 590 M PERFORATED	1516	1400x590x24	1 Pce	50
EchoCove® 24mm DESK ONE 590 L PLAIN	1193	1600x590x24	1 Pce	70
EchoCove® 24mm DESK ONE 590 L PERFORATED	1517	1600x590x24	1 Pce	57
EchoCove® 24mm DESK ONE 590 XL PLAIN	1195	1800x590x24	1 Pce	79
EchoCove® 24mm DESK ONE 590 XL PERFORATED	1518	1800x590x24	1 Pce	65

**ECHOCOVE® 24MM  
DESK ONE 470 S**



**ECHOCOVE® 24MM  
DESK ONE 470 M**



**ECHOCOVE® 24MM  
DESK ONE 470 L**



**ECHOCOVE® 24MM  
DESK ONE 470 XL**



**ECHOCOVE® 24MM  
DESK ONE 590 S**



**ECHOCOVE® 24MM  
DESK ONE 590 M**



**ECHOCOVE® 24MM  
DESK ONE 590 L**



**ECHOCOVE® 24MM  
DESK ONE 590 XL**





# ECHOCOVE® 24MM DESK TWO

Frameless acoustic wall with 300mm privacy screen under the tabletop incl. high-quality table adapter, deep matt powder-coated.

Absorption coefficient:  $\alpha_w$  1.00, class A

Please specify the table adapter type when ordering. (Page 217)

This product is available with our perforations. (Page 241)

NAME	ARTICLE	W x H x D (in mm)	UNIT	PET-BOTTLES
EchoCove® 24mm DESK TWO 470 XS PLAIN	1196	790x770x24	1 Pce	46
EchoCove® 24mm DESK TWO 470 XS PERFORATED	1519	790x770x24	1 Pce	37
EchoCove® 24mm DESK TWO 470 S PLAIN	1198	1180x770x24	1 Pce	68
EchoCove® 24mm DESK TWO 470 S PERFORATED	1520	1180x770x24	1 Pce	56
EchoCove® 24mm DESK TWO 470 M PLAIN	1200	1400x770x24	1 Pce	81
EchoCove® 24mm DESK TWO 470 M PERFORATED	1521	1400x770x24	1 Pce	66
EchoCove® 24mm DESK TWO 470 L PLAIN	1202	1600x770x24	1 Pce	92
EchoCove® 24mm DESK TWO 470 L PERFORATED	1522	1600x770x24	1 Pce	76
EchoCove® 24mm DESK TWO 470 XL PLAIN	1204	1800x770x24	1 Pce	104
EchoCove® 24mm DESK TWO 470 XL PERFORATED	1523	1800x770x24	1 Pce	85
EchoCove® 24mm DESK TWO 590 XS PLAIN	1197	790x890x24	1 Pce	53
EchoCove® 24mm DESK TWO 590 XS PERFORATED	1524	790x890x24	1 Pce	43
EchoCove® 24mm DESK TWO 590 S PLAIN	1199	1180x890x24	1 Pce	79
EchoCove® 24mm DESK TWO 590 S PERFORATED	1525	1180x890x24	1 Pce	65
EchoCove® 24mm DESK TWO 590 M PLAIN	1201	1400x890x24	1 Pce	94
EchoCove® 24mm DESK TWO 590 M PERFORATED	1526	1400x890x24	1 Pce	77
EchoCove® 24mm DESK TWO 590 L PLAIN	1203	1600x890x24	1 Pce	107
EchoCove® 24mm DESK TWO 590 L PERFORATED	1527	1600x890x24	1 Pce	88
EchoCove® 24mm DESK TWO 590 XL PLAIN	1205	1800x890x24	1 Pce	120
EchoCove® 24mm DESK TWO 590 XL PERFORATED	1528	1800x890x24	1 Pce	99

ECHOCOVE® 24MM  
DESK TWO 470 XS



ECHOCOVE® 24MM  
DESK TWO 470 S



ECHOCOVE® 24MM  
DESK TWO 470 M



ECHOCOVE® 24MM  
DESK TWO 470 L

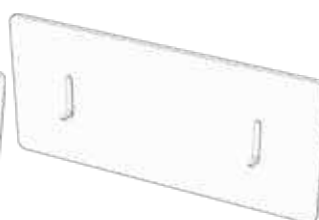

ECHOCOVE® 24MM  
DESK TWO 470 XL

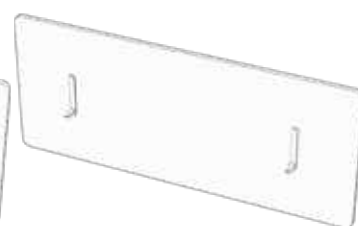

ECHOCOVE® 24MM  
DESK TWO 590 XS



ECHOCOVE® 24MM  
DESK TWO 590 S



ECHOCOVE® 24MM  
DESK TWO 590 M



ECHOCOVE® 24MM  
DESK TWO 590 L

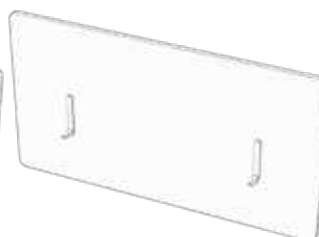

ECHOCOVE® 24MM  
DESK TWO 590 XL

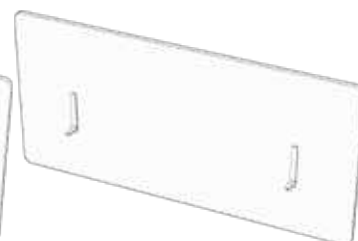



## ECHOCOVE® BOW

The new EchoCove® BOW room divider is an acoustic absorber set in a metal frame with a solid base and a 45 degree curve.



COMPANY PROFILE

MATERIAL

CEILING

LIGHTING

WALLS

PARTITIONS

FURNITURE

ADDITIONAL ITEMS

CREATE

# ECHOCOVE® 24MM BOW

Acoustic partition wall for installation on the floor as a room divider or room-in-room solution incl. high-quality base, deep matt powder-coated (no tools required).

Absorption coefficient:  $\alpha_w$  1.00, class A

NAME	ARTICLE	ØxH (in mm)	UNIT	PET-BOTTLES
EchoCove® 24mm BOW VERTIGO (Set of 2)	1683-1	1203x1810x294	Set of 2	300
EchoCove® 24mm BOW VERTIGO (1 pce)	1688-1	1203x1810x294	1 pce	150
EchoCove® 24mm BOW WOVEN (Set of 2)	1683-3	1203x1810x294	Set of 2	300
EchoCove® 24mm BOW WOVEN (1 pce)	1688-3	1203x1810x294	1 pce	150
EchoCove® 24mm BOW SERENITY (Set of 2)	1683-2	1203x1810x294	Set of 2	300
EchoCove® 24mm BOW SERENITY (1 pce)	1688-2	1203x1810x294	1 pce	150
EchoCove® 24mm BOW MAGNETIC STRIPE	1689	25x2	Set of 2	

ECHOCOVE® 24MM BOW  
VERTIGO

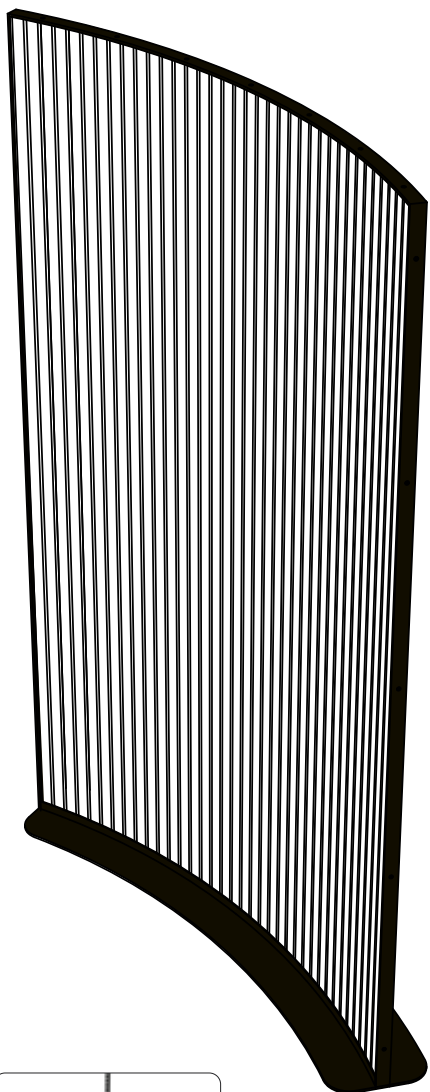

ECHOCOVE® 24MM BOW  
WOVEN

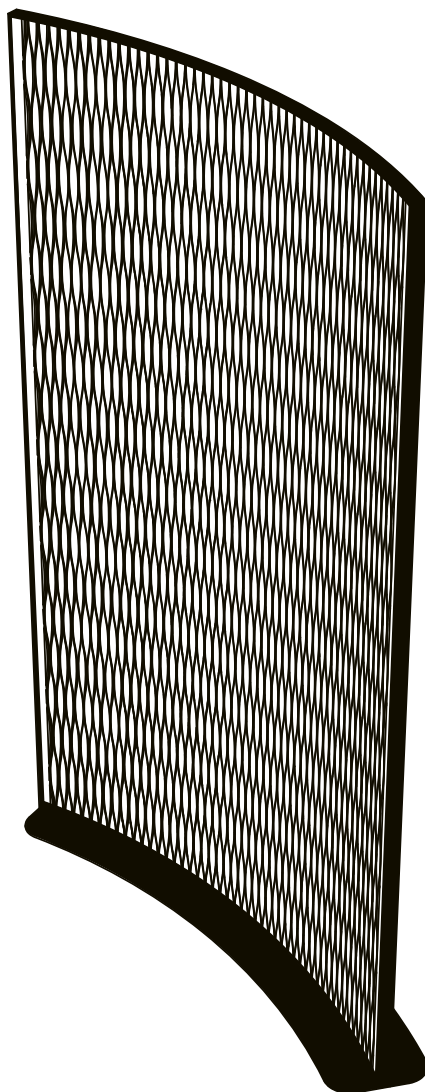

ECHOCOVE® 24MM BOW  
SERENITY

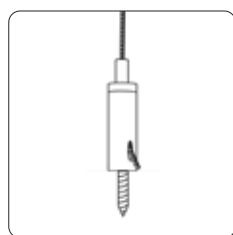
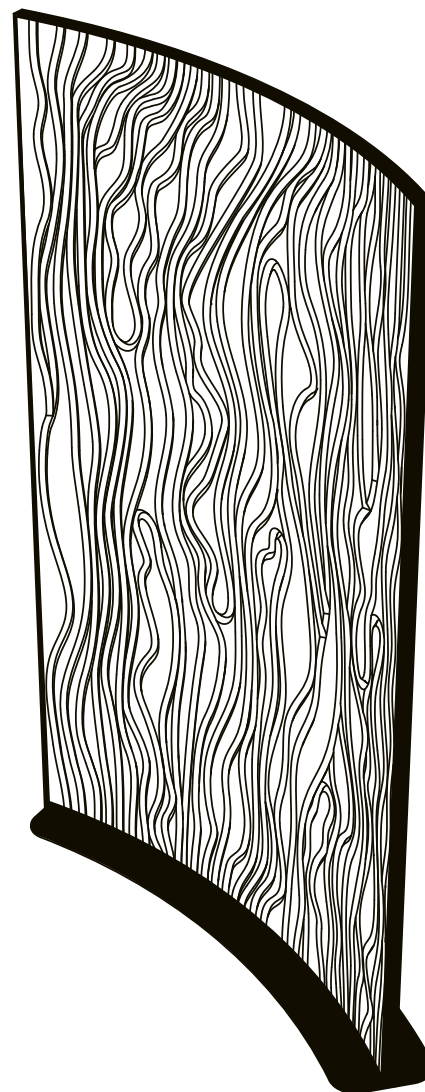

DIRECT SUSPENSION



COMPANY PROFILE

MATERIAL

CEILING

LIGHTING

WALLS

PARTITIONS

FURNITURE

ADDITIONAL ITEMS

CREATE





COMPANY PROFILE

MATERIAL

CEILING

LIGHTING

WALLS

PARTITIONS

FURNITURE

ADDITIONAL ITEMS

CREATE

## ACOUSTIC-FURNITURE

Design and function combined in one: acoustic furniture are utility and design elements made of EchoBoard® for improving the sound environment in rooms of all kinds.



## ECHOCRATE®

EchoCrate® is the elegant acoustic solution for storage space in a small area. The EchoBoard® wall panel can be configured in any colour and shape and can be used in a wide variety of areas. The seemingly floating wall shelf is mounted on a powder-coated metal frame or a customised solution.

For the first time, the design combines two recycling concepts of beverage packaging, PET bottles and wine crates. Recycled PET was used to produce the decorative acoustic board and the practical shelves are made from upcycled wooden crates.



COMPANY PROFILE

MATERIAL

CEILING

LIGHTING

WALLS

PARTITIONS

FURNITURE

ADDITIONAL ITEMS

CREATE

# ECHOCRATE® 24MM

Acoustic panels in various shapes and surface designs combined with storage made out of wooden crates incl. wall suspension.

Absorption coefficient:  $\alpha_w$  0.90, class A

Corner radius: 40mm

When ordering EchoCrate® RECTANGLE M & L items (ECR24REC079180- & ECR24REC120180-), please specify the type of suspension profile. ([Page 221](#))

NAME	ARTICLE	W x H x D (in mm)	UNIT	PET-BOTTLES
EchoCrate® 24mm HEXAGON LIGHT	1158	1350x1180x180mm	1 pce	91
EchoCrate® 24mm HEXAGON BALANCED	1156	1350x1180x180mm	1 pce	91
EchoCrate® 24mm HEXAGON COMPACT	1157	1350x1180x180mm	1 pce	91
EchoCrate® 24mm ROUND LIGHT	1170	1250x1250x180mm	1 pce	92
EchoCrate® 24mm ROUND BALANCED	1168	1250x1250x180mm	1 pce	92
EchoCrate® 24mm ROUND COMPACT	1169	1250x1250x180mm	1 pce	92
EchoCrate® 24mm SQUARE LIGHT	1173	1195x1195x180mm	1 pce	107
EchoCrate® 24mm SQUARE BALANCED	1171	1195x1195x180mm	1 pce	107
EchoCrate® 24mm SQUARE COMPACT	1172	1195x1195x180mm	1 pce	107
EchoCrate® 24mm RECTANGLE S LIGHT	1161	790x1000x180mm	5 pce	296
EchoCrate® 24mm RECTANGLE S BALANCED	1159	790x1000x180mm	5 pce	296
EchoCrate® 24mm RECTANGLE S COMPACT	1160	790x1000x180mm	5 pce	296
EchoCrate® 24mm RECTANGLE M LIGHT	1164	790x1800x180mm	1 pce	107
EchoCrate® 24mm RECTANGLE M BALANCED	1162	790x1800x180mm	1 pce	107
EchoCrate® 24mm RECTANGLE M COMPACT	1163	790x1800x180mm	1 pce	107
EchoCrate® 24mm RECTANGLE L LIGHT	1167	1195x1800x180mm	1 pce	161
EchoCrate® 24mm RECTANGLE L BALANCED	1165	1195x1800x180mm	1 pce	161
EchoCrate® 24mm RECTANGLE L COMPACT	1166	1195x1800x180mm	1 pce	161

ECHOCRATE® 24MM  
HEXAGON LIGHT

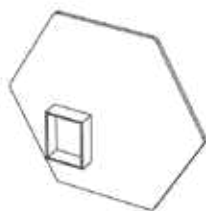

ECHOCRATE® 24MM  
HEXAGON BALANCED

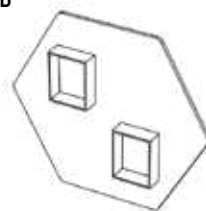

ECHOCRATE® 24MM  
HEXAGON COMPACT

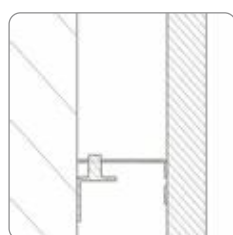
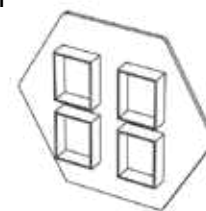

WALL SUSPENSION

ECHOCRATE® 24MM  
ROUND LIGHT

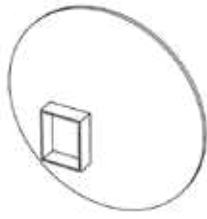

ECHOCRATE® 24MM  
ROUND BALANCED

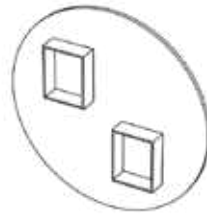

ECHOCRATE® 24MM  
ROUND COMPACT

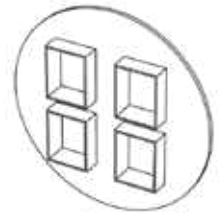

ECHOCRATE® 24MM  
SQUARE LIGHT

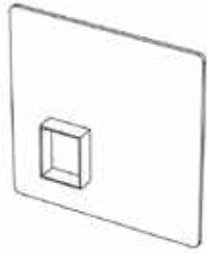

ECHOCRATE® 24MM  
SQUARE BALANCED

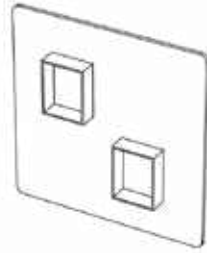

ECHOCRATE® 24MM  
SQUARE COMPACT

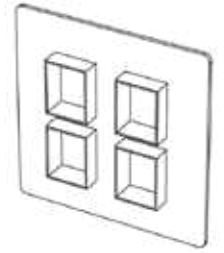

ECHOCRATE® 24MM  
RECTANGLE S LIGHT



ECHOCRATE® 24MM  
RECTANGLE S BALANCED



ECHOCRATE® 24MM  
RECTANGLE S COMPACT

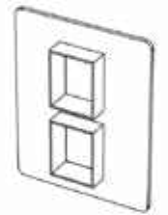

ECHOCRATE® 24MM  
RECTANGLE M LIGHT



ECHOCRATE® 24MM  
RECTANGLE M BALANCED

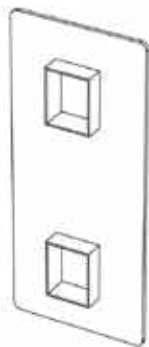

ECHOCRATE® 24MM  
RECTANGLE M COMPACT

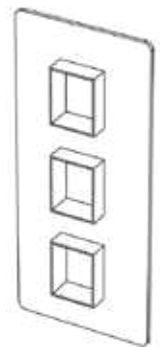

ECHOCRATE® 24MM  
RECTANGLE L LIGHT

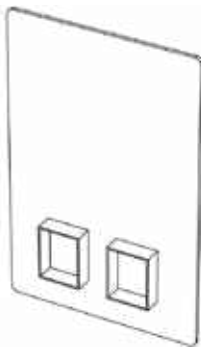

ECHOCRATE® 24MM  
RECTANGLE L BALANCED

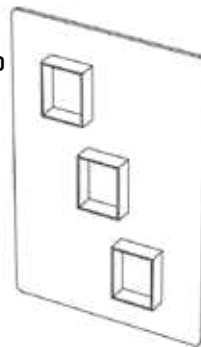

ECHOCRATE® 24MM  
RECTANGLE L COMPACT

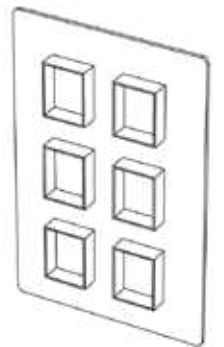



## ECHONOTE®

EchoNote® is a high-quality whiteboard with a pinboard on the back. It also serves as a functional, movable and sound-absorbing room divider. The magnetic board and the EchoBoard® acoustic panel are embedded in a minimalist frame made of powder-coated steel, the elegant feet are on castors.

EchoNote® cleverly adapts to the layout needs of offices, training rooms or meeting rooms. The large display area supports collaborative work

COMPANY PROFILE

MATERIAL

CEILING

LIGHTING

WALLS

PARTITIONS

FURNITURE

ADDITIONAL ITEMS

CREATE





# ECHONOTE® 12MM

High-performance acoustic whiteboard consisting of a pin board with textile surface made of 100% PET and a classic whiteboard surface. Optionally available with cover plates.

Absorption coefficient: [aw 0.30](#)

This product is optionally available with our magnetic cover plates. ([Page 223](#))

NAME	ARTICLE	W x H x D (in mm)	UNIT	PET-BOTTLES
EchoNote® 12mm	1695	1190x1900x430	1 pce	101

ECHONOTE® 12MM

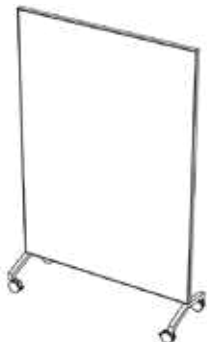



## ECHOTOWER® SQUARE

The EchoTower® is the pioneering product in zero noise and zero waste for any space. The acoustic column is cut from a sheet of EchoBoard®, the high-performance absorber made from recycled PET bottles. But that's not all. With a Zero Waste goal, ECHO**JAZZ** products are taken back and shredded into EchoFlakes® along with offcuts. Filled with these flakes, the EchoTower® increases acoustic well-being and closes the material cycle. The EchoTower® requires no assembly. A base, with or without castors, made of powder-coated sheet steel is optional.



COMPANY PROFILE

MATERIAL

CEILING

LIGHTING

WALLS

PARTITIONS

FURNITURE

ADDITIONAL ITEMS

CREATE

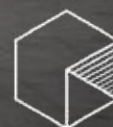

**archiproducts**  
DESIGN AWARDS  
—  
WINNER 2020



# ECHOTOWER® 24MM SQUARE

Free-standing acoustic column with black aluminium profile on backside and optional adjustable base made of powder-coated steel (with or without castors).

Absorption coefficient:  $\alpha_w$  1.00, class A

More information about the product EchoTower® is available at [www.echojazz.com/echotower-square](http://www.echojazz.com/echotower-square)



NAME	ARTICLE	W x H x D (in mm)	UNIT	PET-BOTTLES
EchoTower® SQUARE M ECO	1181	396x980x396	1 pce	399
EchoTower® SQUARE M STAND	1185	550x982x550	1 pce	399
EchoTower® SQUARE M MOVE	1183	550x1057x550	1 pce	399
EchoTower® SQUARE L ECO	1182	396x1960x396	1 pce	798
EchoTower® SQUARE L STAND	1186	550x1962x550	1 pce	798
EchoTower® SQUARE L MOVE	1184	550x2037x550	1 pce	798

ECHOTOWER® 24MM  
SQUARE M ECO



ECHOTOWER® 24MM  
SQUARE M STAND

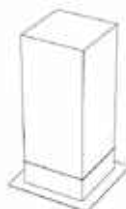

ECHOTOWER® 24MM  
SQUARE M MOVE

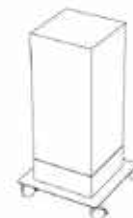

ECHOTOWER® 24MM  
SQUARE L ECO



ECHOTOWER® 24MM  
SQUARE L STAND



ECHOTOWER® 24MM  
SQUARE L MOVE



**archiproducts**  
DESIGN AWARDS

—  
WINNER 2020



## ECHOTOWER® ROUND

The EchoTower® is the leading product in zero noise and zero waste for every room. The acoustic column is cut from a single piece of EchoBoard®, the high-performance absorber made from recycled PET bottles. But that is not all, with a zero waste target, ECHOJAZZ products are taken back and shredded together with offcuts to produce EchoFlakes®. Filled with these flakes, the EchoTower® increases the acoustic comfort and closes the material cycle. The EchoTower® is freestanding. A stand base, with or without wheels, made of powder-coated steel is optional.

The acoustic column with relief structure is an eye-catcher that achieves outstanding absorption values and ensures well-being. The recyclable EchoTower® stands for sustainability by design without compromise - with more than 465 recycled PET bottles per tower.



COMPANY PROFILE

MATERIAL

CEILING

LIGHTING

WALLS

PARTITIONS

FURNITURE

ADDITIONAL ITEMS

CREATE



# ECHOTOWER® 24MM ROUND

Free-standing acoustic filled with sound absorbing EchoFlakes®.

Absorption coefficient:  $\alpha_w$  1.00, class A

More information about the product EchoTower® is available at [www.echojazz.com/echotower-round](http://www.echojazz.com/echotower-round)

NAME	ARTICLE	Ø x H (in mm)	UNIT	PET-BOTTLES
EchoTower® 24mm ROUND M WAVY ECO	1179	367x924	1 Pce	249
EchoTower® 24mm ROUND L WAVY ECO	1180	367x1800	1 Pce	465

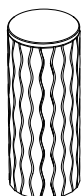

ECHOTOWER® 24MM  
ROUND M WAVY ECO

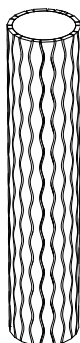

ECHOTOWER® 24MM  
ROUND L WAVY ECO



## MCART

The **MCart** workstation offers the combination of personal focus space with mobile adaptability. Its compact dimensions make it suitable for working in an open office as well as a home office. The starting point for the design is an open steel frame. **ECHOJAZZ** panels define a semi-enclosed workspace with optimal sound insulation, simple body and colour accent. The acoustics in the overall space are also significantly improved. A gas lift column allows the height of the worktop to be adjusted from 70 to 112 cm in a matter of seconds. From standing to sitting and vice versa in real time.



COMPANY PROFILE

MATERIAL

CEILING

LIGHTING

WALLS

PARTITIONS

FURNITURE

ADDITIONAL ITEMS

CREATE



# MCART 12MM

Mobile acoustic workstation on wheels with integrated plug-in bar and hydraulically height-adjustable table top.

Absorption coefficient:  $\alpha_w$  0.90, class A

Please chose the right MCard ELECTRICAL SOCKET type (CH/EU/UK) when ordering. (Page 219)

More information about the product MCard is available at [www.echojazz.com/mcart](http://www.echojazz.com/mcart)

NAME	ARTICLE	W x H x D (in mm)	UNIT	PET-BOTTLES
MCard 12mm ZERO	1010	1228x1473x613	1 pce	145
MCard 12mm ONE	1021	1456x1473x613	1 pce	189
MCard 12mm TWO	1022	1681x1473x613	1 pce	232

**MCART 12MM  
ZERO**



**MCART 12MM  
ONE**



**MCART 12MM  
TWO**





## ECHOCARRY

The EchoCarry is an office organiser for personal equipment. At the workplace, laptop, accessories, office materials and private things are always well tidied and easily at hand thanks to two storage positions. The integrated handle allows the toolbox to be quickly stored in a compartment or cupboard at the end of the working day.

The elegant office companion is made of the acoustic absorber EchoBoard® around a stable wooden board made of European birch. In use, it is very quiet and muffles ambient noise. The EchoCarry symbolises the focus on ergonomics in the modern mobile working environment.



COMPANY PROFILE

MATERIAL

CEILING

LIGHTING

WALLS

PARTITIONS

FURNITURE

ADDITIONAL ITEMS

CREATE



# ECHOCARRY 12MM

Mobile acoustic office-organiser in two sizes with integrated handle and optional leather straps.

Absorption coefficient:  $\alpha_w$  0.90, class A

When ordering, please indicate whether you wish to receive the EchoCarry with the optional leather straps

You can find more information about the EchoCarry at [www.echojazz.com/echocarry](http://www.echojazz.com/echocarry)



NAME	ARTICLE	W x H x D (in mm)	UNIT	PET-BOTTLES
EchoCarry 12mm WOOD M	1630	400x312x190	1 Pce	18
EchoCarry 12mm WOOD L	1668	524x250x177	1 Pce	20
EchoCarry 12mm THERMO M	1670	400x312x190	1 Pce	18
EchoCarry 12mm THERMO L	1669	524x250x177	1 Pce	20
EchoCarry 12mm LEATHER STRAPS	1155	210x19x3	2 Pce	

ECHOCARRY 12MM M

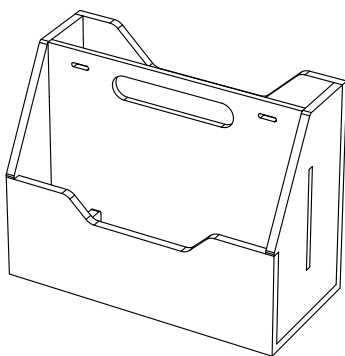

ECHOCARRY 12MM M  
+ LEATHER STRAPS

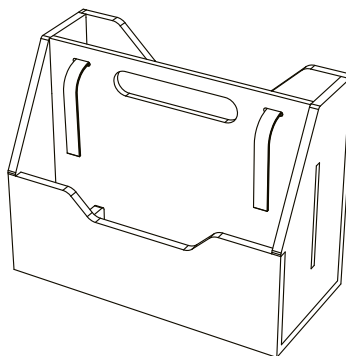

ECHOCARRY 12MM L

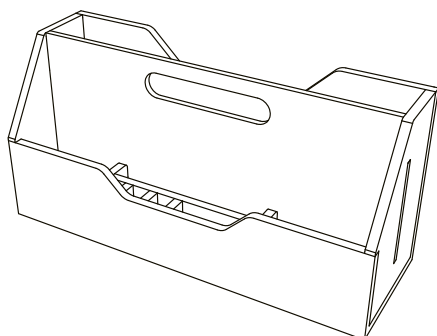



## ECHOBX®

In the Open Office, telephone calls and video calls at the workplace can be disturbing. The sound-protected EchoBox® ensures privacy and less disruptive noise. A room within a room for short and focused conversations, while standing or sitting. Thanks to the integrated height-adjustable shelf, there is also room for documents or a laptop. The conversation booth can be assembled in no time without tools. Its 7 parts weigh only 42kg.

The EchoBox® is a Swiss product that resulted from an intensive development cooperation between SYMA Profile and Fastening Technology and ECHO **JAZZ** Acoustic Absorbers.

We build Acoustic Inspiration.



COMPANY PROFILE

MATERIAL

CEILING

LIGHTING

WALLS

PARTITIONS

FURNITURE

ADDITIONAL ITEMS

CREATE



# ECHOBOX® 24MM

Stand-alone quiet booth with height-adjustable table and fold-away chair.

Absorption coefficient:  $\alpha_w$  1.00, class A

Tool-free assembly

More information about the product EchoBox® is available at [www.echojazz.com/echobox](http://www.echojazz.com/echobox)

NAME	ARTICLE	W x H x D (in mm)	UNIT	PET-BOTTLES
EchoBox® 24mm SILVER FRAME	1151	840x2200x840	1 pce	582
EchoBox® 24mm WHITE FRAME	1152	840x2200x840	1 pce	582
EchoBox® 24mm BLACK FRAME	1146	840x2200x840	1 pce	582
EchoBox® 24mm SILVER FRAME (+ GLASS DOOR)	1150	840x2200x840	1 Pce	582
EchoBox® 24mm WHITE FRAME (+ GLASS DOOR)	1153	840x2200x840	1 Pce	582
EchoBox® 24mm BLACK FRAME (+ GLASS DOOR)	1145	840x2200x840	1 Pce	582

ECHOBOX® 24MM

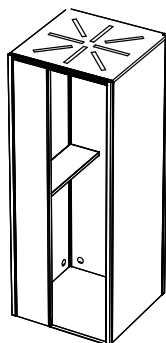

ECHOBOX® 24MM  
+ GLASS DOOR

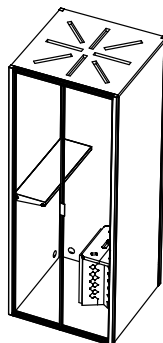

## ECHOSTOOL®

The EchoStool® is more than just a stool: it reduces the noise level and creates a pleasant, quiet atmosphere. Whether in quiet zones, during creative breaks or inspiring conversations. Made from 100% EchoBoard®, it is completely free of screws, metal or other additional materials. This makes it completely recyclable and a real role model in the circular economy.

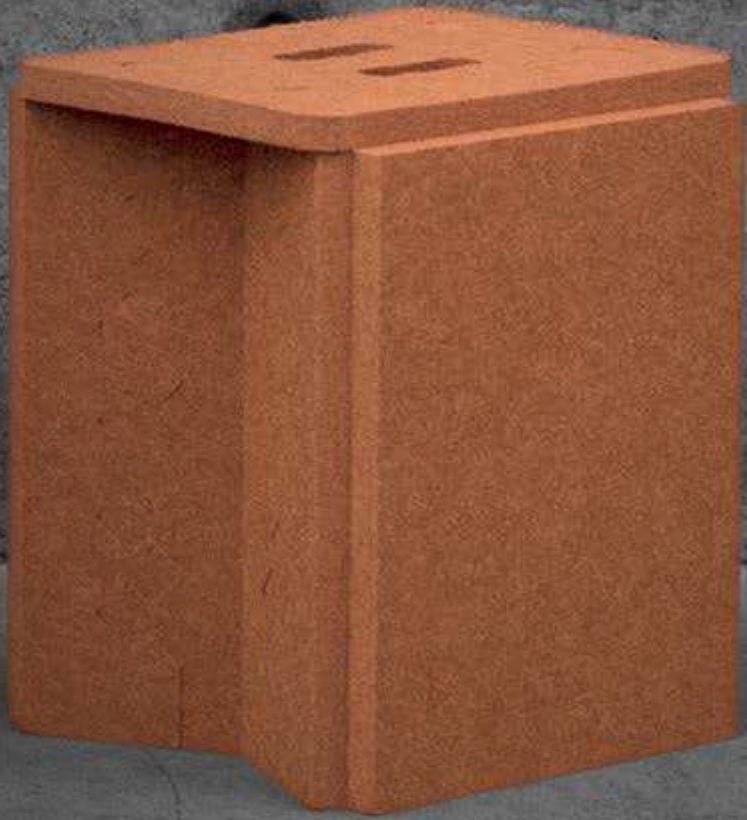



# ECHOSTOOL® 24MM

Folding stool made of high-performance acoustic absorber with textile surface made of 100% PET.

Absorption coefficient:  $\alpha_w$  1.00, class A

Tool-free assembly

You can find more information about the EchoStool® at [www.echojazz.com/echo stool](http://www.echojazz.com/echo stool)

NAME	ARTICLE	W x H x D (in mm)	UNIT	PET-BOTTLES
EchoStool® 24mm (Set of 4)	1692	420x460x350	Set of 4	216
EchoStool® 24mm (1 pce)	1693	420x460x350	1 pce	54

ECHOSTOOL® 24MM

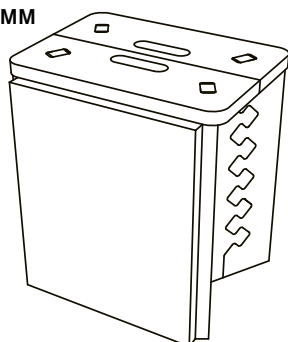





COMPANY PROFILE

MATERIAL

CEILING

LIGHTING

WALLS

PARTITIONS

FURNITURE

ADDITIONAL ITEMS

CREATE

## ADDITIONAL ITEMS

The installation should be from a single source and perfectly matched to the acoustic product. That is why ECHO**JAZZ** has developed its own installation kits and accessories that can be ordered as well. For optimal and seamless project support.



# ECHOCOUSTIC® 25MM PROFILE

EchoCoustic® can optionally be installed with EchoProfile® aluminium profiles. With EchoCoustic® 25mm PROFILE profiles, installation is also possible without adhesive. An EchoCoustic® panel can be easily clamped between two profiles.

This article is part of the product EchoCoustic®. ([Page 26](#))

NAME	ARTICLE	W x H x D (in mm)	UNIT	MATERIAL
EchoCoustic® 25mm PROFILE EDGE	1412	2750x16x27.8	1 pce	Aluminium
EchoCoustic® 25mm PROFILE SPLIT	1413	2750x30.6x27.8	1 pce	Aluminium

ECHOCOUSTIC® 25MM  
PROFILE EDGE

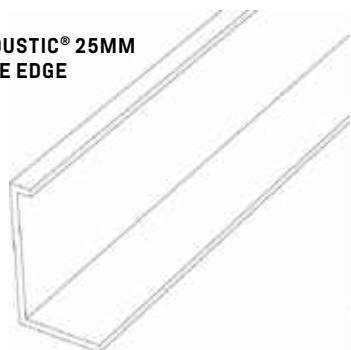

ECHOCOUSTIC® 25MM  
PROFILE SPLIT





## ECHOBaffle® CUSTOM DESIGN

DESIGN: RIPPLE EFFECT

SLAT DISTANCE: 200mm

SUSPENSION SYSTEM: U-PROFILE

SLAT CONNECTIONS: DOVETAIL JOINTS

# ECHOBaffle® CUSTOM DESIGN OPTIONS

EchoBaffle® ceilings are flexible in their application. The slats are available with closed edges or with dovetail connections. To hang the EchoBaffle®, there is the option of a direct suspension system or u-profiles.

[This article is part of the product EchoBaffle®. \(Page 46\)](#)

OPTIONS	DESCRIPTION
Design	PLAIN; CORNER; VOGUE; CUSTOM DESIGN
Slat distance	Distance between slats
Suspension system	Direct suspension; U-profile
Slat connections	Closed edge; Dovetail joint

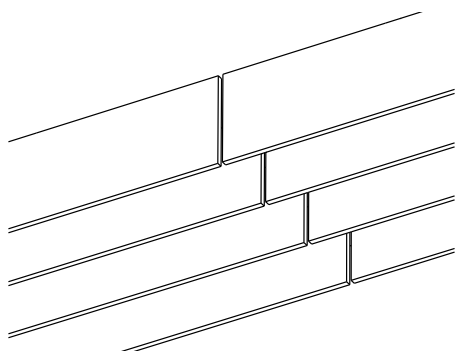

**CLOSED EDGE**

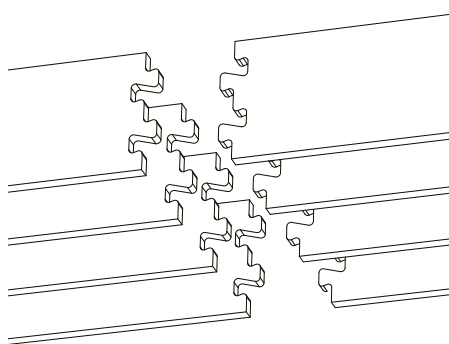

**DOVETAIL JOINT**

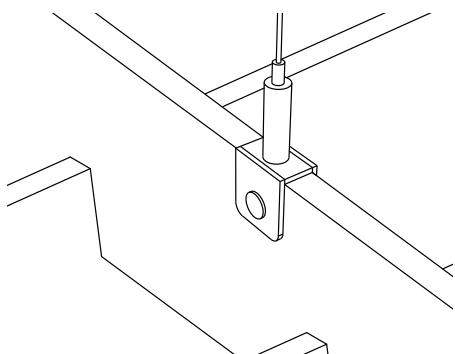

**DIRECT SUSPENSION**

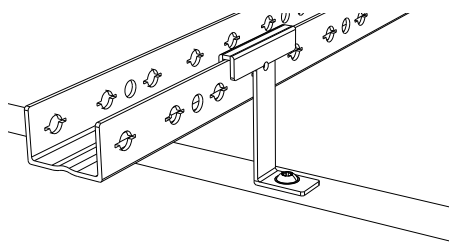

**U-PROFILE SUSPENSION**

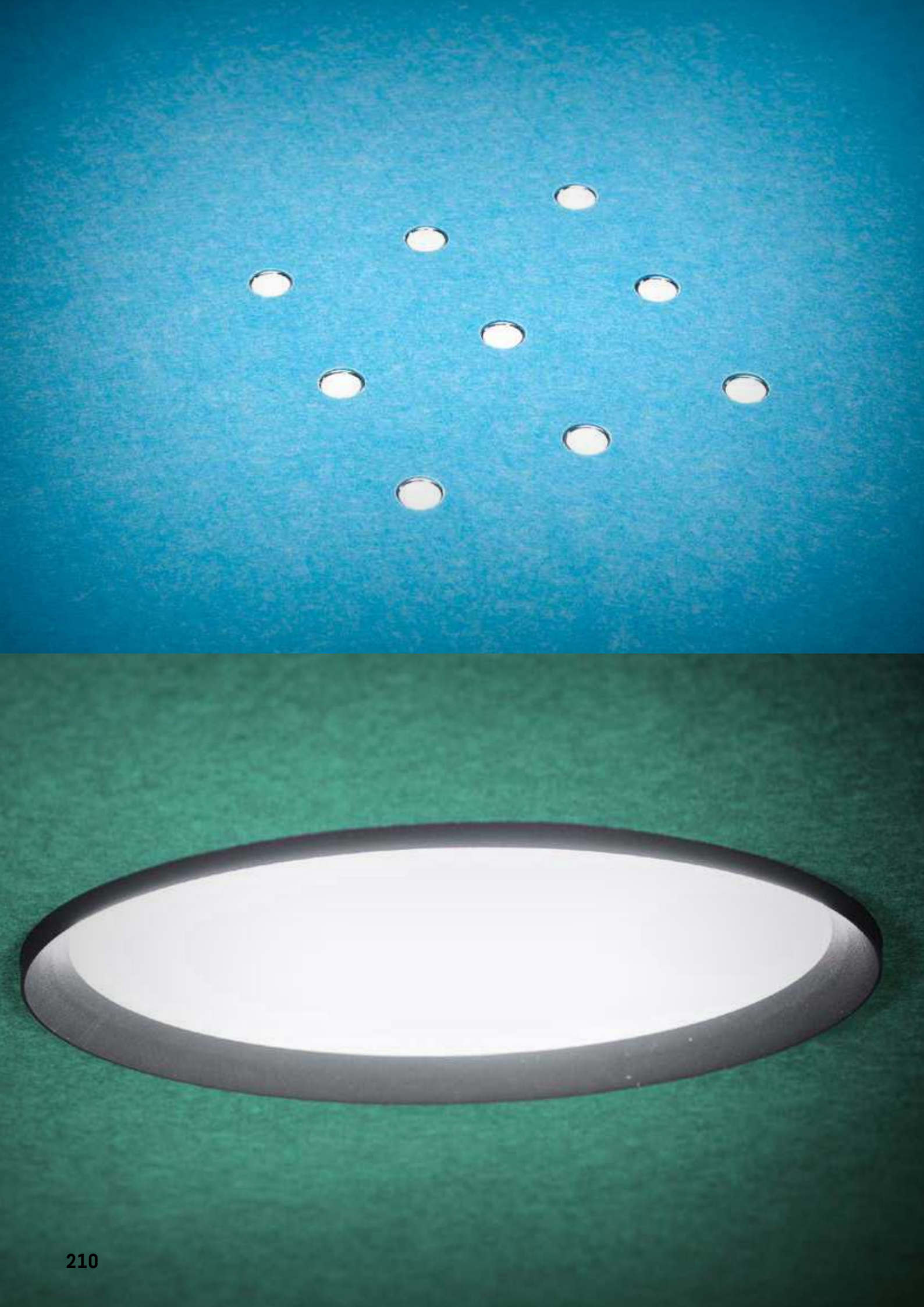

## ECHOLED® NOVEM SPOTS 3X3

EchoLED® NOVEM SPOTS with 9 light points.

[This article refers to the product EchoLED® NOVEM. \(Page 62\)](#)

TYP	ARTICLE	W x H x D (in mm)	LIGHT COLOUR	LUMEN	PERFORMANCE
EchoLED® NOVEM SPOTS 3X3	1345	350x350x60 (9 x Ø30)	4000K	7960lm	78W

<b>SUPPLY VOLTAGE</b>	220-240V 50/60Hz
<b>PROTECTION TYPE/-CLASS</b>	IP 20 / Protection class 1
<b>COLOUR RENDERING INDEX</b>	CRI > 80
<b>ENERGIEEFFIZIENZ</b>	A++
<b>LIFETIME</b>	> 50'000 h (L80 B10)
<b>OPTICS</b>	Vacuum-vapourised reflector
<b>DIMMING MODE</b>	DALI

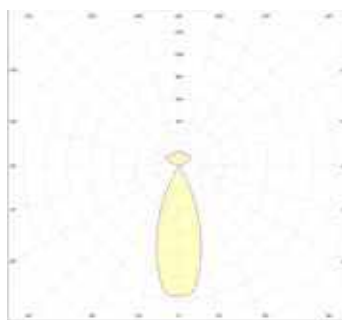

## ECHOLED® SITAS LIGHT-MODULE

The light module for the EchoLED® SITAS acoustic luminaire.

[This article refers to the product EchoLED® SITAS. \(Page 58\)](#)

TYP	ARTICLE	W x H x D (in mm)	LIGHT COLOUR	LUMEN	PERFORMANCE
EchoLED® SITAS SQUARE LIGHT MODULE	1347	400x400x72	4000K	3190lm	30W
EchoLED® SITAS ROUND LIGHT MODULE	1346	Ø400x72	4000K	3430lm	30W

<b>SUPPLY VOLTAGE</b>	220-240V 50/60Hz
<b>PROTECTION TYPE/-CLASS</b>	IP 20 / Protection class 1
<b>COLOUR RENDERING INDEX</b>	CRI > 80
<b>ENERGIEEFFIZIENZ</b>	A++
<b>LIFETIME</b>	> 50'000 h (L80 B10)
<b>OPTICS</b>	Microprism cover
<b>UGR</b>	< 19
<b>DIMMING MODE</b>	DALI

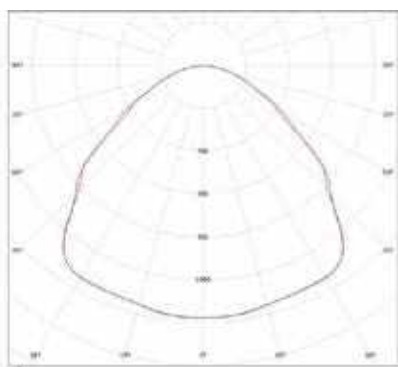

ECHOLED® SITAS SQUARE

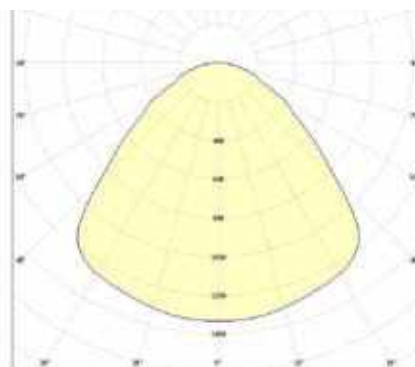

ECHOLED® SITAS ROUND

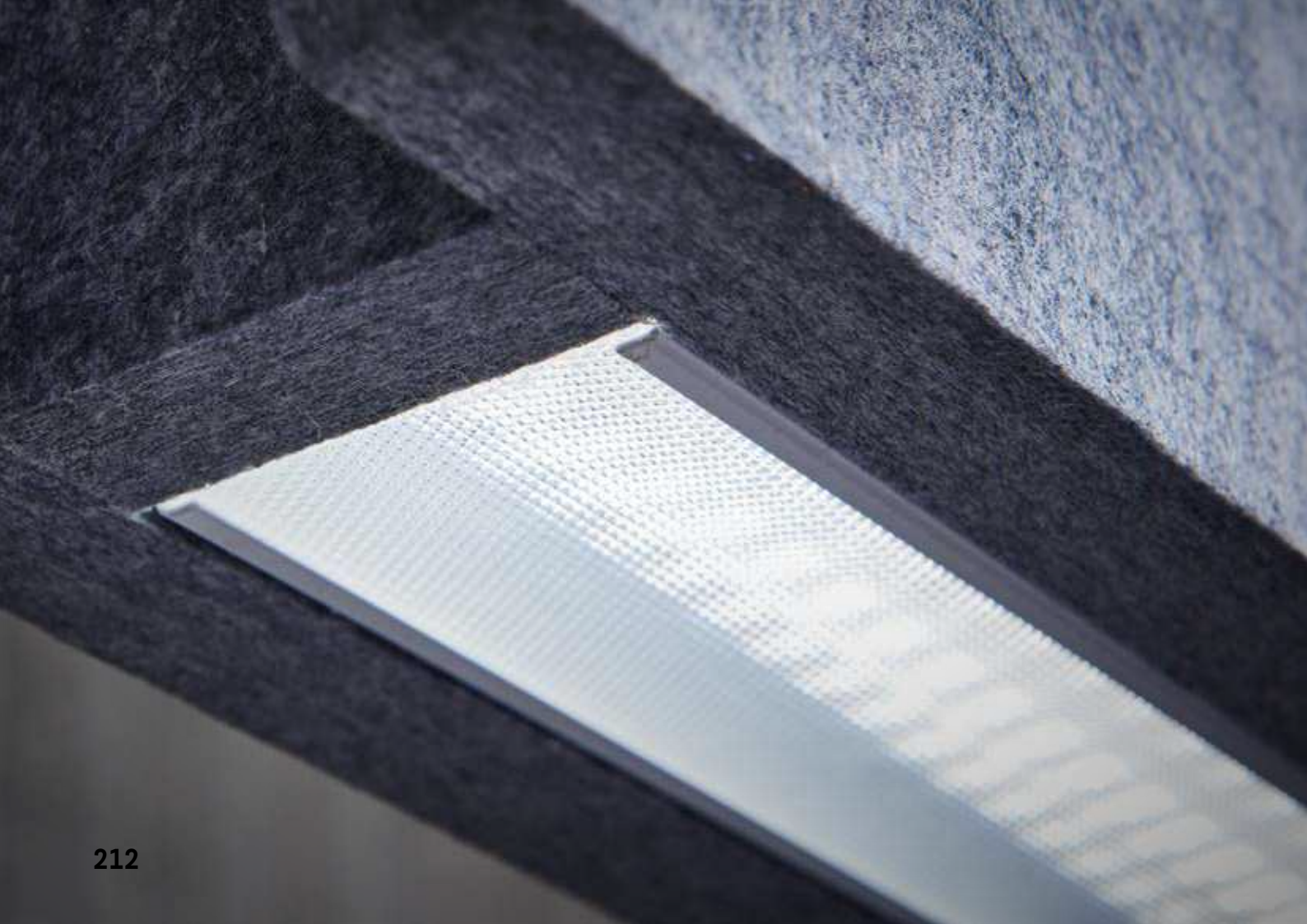

## ECHOLED® EQ4 PIN BY BARTENBACH

The EchoLED® EQ4 PIN with four light points was developed in cooperation with Bartenbach, the competence partner for light sources.

[This article is part of the product EchoLED® EQ4. \(Page 66\)](#)

[This article is part of the product EchoLED® UMBRA. \(Page 82\)](#)

TYP	ARTICLE	W x H x D (in mm)	LIGHT COLOURS	LUMEN	PERFORMANCE
EQ4 3000	1024-3000	486x73.9x50 (4 x Ø30)	3000K	1320lm	22W
EQ4 4000	1024-4000	486x73.9x50 (4 x Ø30)	4000k	1320lm	22W

<b>SUPPLY VOLTAGE</b>	220-240V 50/60Hz
<b>PROTECTION TYPE/-CLASS</b>	IP 40 / Schutzklasse 1
<b>COLOUR RENDERING INDEX</b>	CRI > 90 (4000K)
<b>COLOUR CONSISTENCY</b>	< 3SDMC
<b>ENERGIEEFFIZIENZ</b>	A++
<b>LIFETIME</b>	> 50'000 h (L80 B10)
<b>UGR</b>	< 16

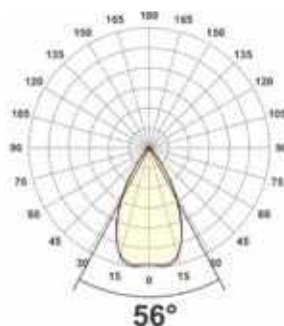

**Bartenbach** <sup>®</sup>

## ECHOLED® LINEAR LED

The EchoLED® LINEAR LED light module with different light colours and dimensions. 3000K available on request.

[This article is part of the product EchoLED® LINEAR. \(Page 86\)](#)

TYP	ARTICLE	W x H x D (in mm)	LIGHT COLOUR	LUMEN	PERFORMANCE
M 4000	1027-4000	1420x69x90	4000K	4700lm	37W
L 4000	1028-4000	1980x69x90	4000K	6100lm	48W

<b>SUPPLY VOLTAGE</b>	230 V +/- 10% AC/DC
<b>PROTECTION TYPE/-CLASS</b>	IP 20 / Schutzklasse 1
<b>COLOUR RENDERING INDEX</b>	CRI > 80
<b>COLOUR CONSISTENCY</b>	< 3SDMC
<b>ENERGIEEFFIZIENZ</b>	A++
<b>LIFETIME</b>	> 50'000 h (L80 B10)
<b>DIFFUSOR</b>	Microprism cover
<b>UGR</b>	< 19

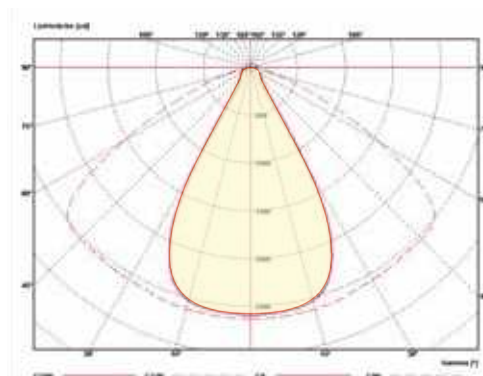



# ECHOCOVE® JOINER

Plastic plug-in connector for mounting EchoCove® ECO and EchoCove® PALING partitions without tools.

This item is only available with the products EchoCove® ECO & PALING. [\(Page 142\)](#)

NAME	ARTICLE	W x H x D (in mm)	UNIT	MATERIAL
EchoCove® JOINER 90	1325	129x30x129	1 pce	ABS
EchoCove® JOINER 120	1328	112x30x129	1 pce	ABS
EchoCove® JOINER PIVOT	1330	28x25x209	1 pce	ABS
EchoCove® JOINER STRAIGHT	1331	29x30x129	1 pce	ABS
EchoCove® JOINER T	1334	197x30x129	1 pce	ABS
EchoCove® JOINER X	1336	229x30x229	1 pce	ABS

ECHOCOVE® JOINER  
120

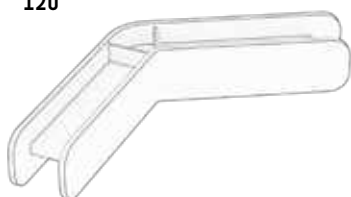

ECHOCOVE® JOINER  
90



ECHOCOVE® JOINER  
PIVOT



ECHOCOVE® JOINER  
STRAIGHT



ECHOCOVE® JOINER  
T

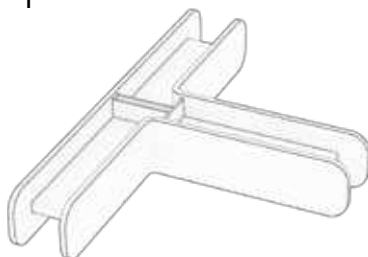

ECHOCOVE® JOINER  
X

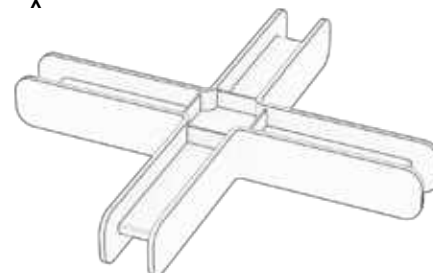



# ECHOCOVE® DESK ADAPTER

Powder coated metal adapter for mounting EchoCove® 24mm DESK ONE and DESK TWO desk dividers.

Colour adapter: [Black RAL9005](#)

This item is only available with the product EchoCove® DESK. ([Page 160](#))

NAME	ARTICLE	W x H x D (in mm)	UNIT	MATERIAL
EchoCove® DESK ADAPTER A	1023-10	25x200x102 (Direct mounting)	1 pce	Powder-coated steel
EchoCove® DESK ADAPTER B	1023-20	25x218x68 (Clamping range up to 30mm)	1 pce	Powder-coated steel
EchoCove® DESK ADAPTER C	1023-30	25x262x68 (Clamping range 46-75mm)	1 pce	Powder-coated steel
EchoCove® DESK ADAPTER D	1023-40	25x218x73.5 (Clamping range up to 30mm)	1 pce	Powder-coated steel

\*The EchoCove® DESK ADAPTER D is offered exclusively in combination with EchoCove® 24mm DESK ONE product variations.

ECHOCOVE® ADAPTER A

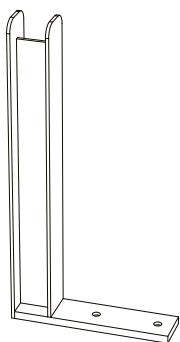

ECHOCOVE® ADAPTER B

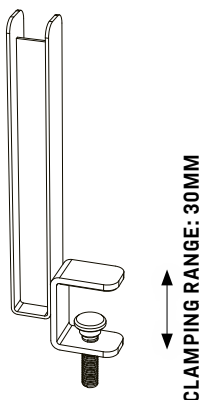

ECHOCOVE® ADAPTER C

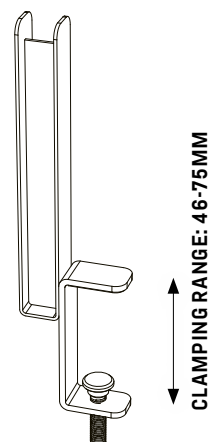

\*ECHOCOVE® ADAPTER D

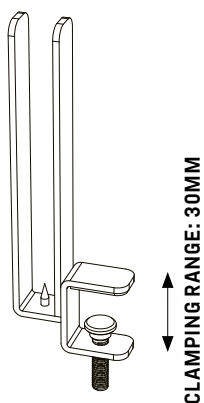



# MCART ELECTRICAL SOCKET

Powder coated metal adapter for mounting EchoCove® 24mm DESK ONE and DESK TWO desk dividers.

Colour adapter: [Black RAL9005](#)

This article is part of the product MCart. ([Page 188](#))

NAME	ARTICLE	W x H x D (in mm)	UNIT	MATERIAL
CH	1020-100	215x37x50	1 pce	Stahl pulverbeschichtet
EU	1020-102	215x37x50	1 pce	Stahl pulverbeschichtet
UK	1020-101	215x37x50	1 pce	Stahl pulverbeschichtet

MCART ELECTRICAL SOCKET  
CH

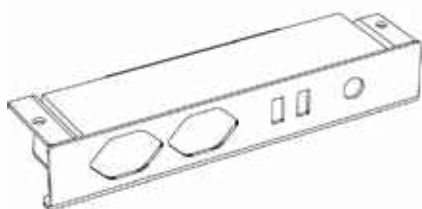

MCART ELECTRICAL SOCKET  
EU

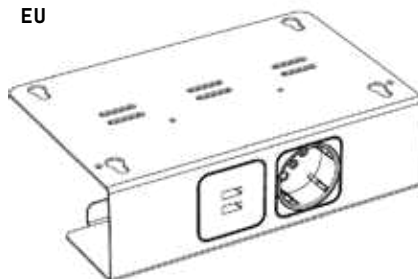

MCART ELECTRICAL SOCKET  
UK

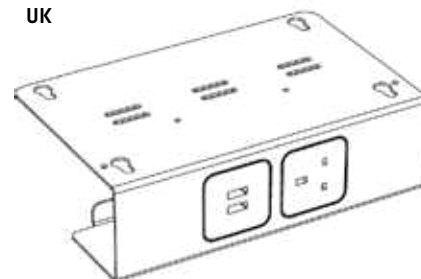



# ECHOCRATE® SUSPENSION PROFILE

Depending on how the EchoCrate® RECTANGLE M & L products are hung, a different suspension profile is required. Please specify the correct suspension profile when ordering.

This article relates to the products EchoCrate® RECTANGLE M & L. (Page 174)

NAME	ARTICLE	W x H x D (in mm)	UNIT	MATERIAL
Horizontal Orientation	1355	1050x50x20	1 pce	Steel powdercoated
Vertical Orientation	1354	550x50x20	1 pce	Steel powdercoated

**SUSPENSION PROFILE  
HORIZONTAL ORIENTATION**



**SUSPENSION PROFILE  
VERTICAL ORIENTATION**



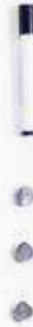

# ECHONOTE® 12MM COVER

Pinable cover plate, which can be easily attached to and removed from the whiteboard thanks to magnets on the back.

This article is part of the product EchoNote®. ([Page 179](#))

NAME	ARTICLE	W x H x D (in mm)	UNIT	MATERIAL
EchoNote® 12mm COVER	1176	595x855x12	2 pce	EchoBoard® 12mm

ECHONOTE® 12MM COVER

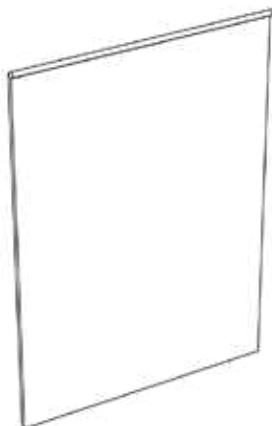

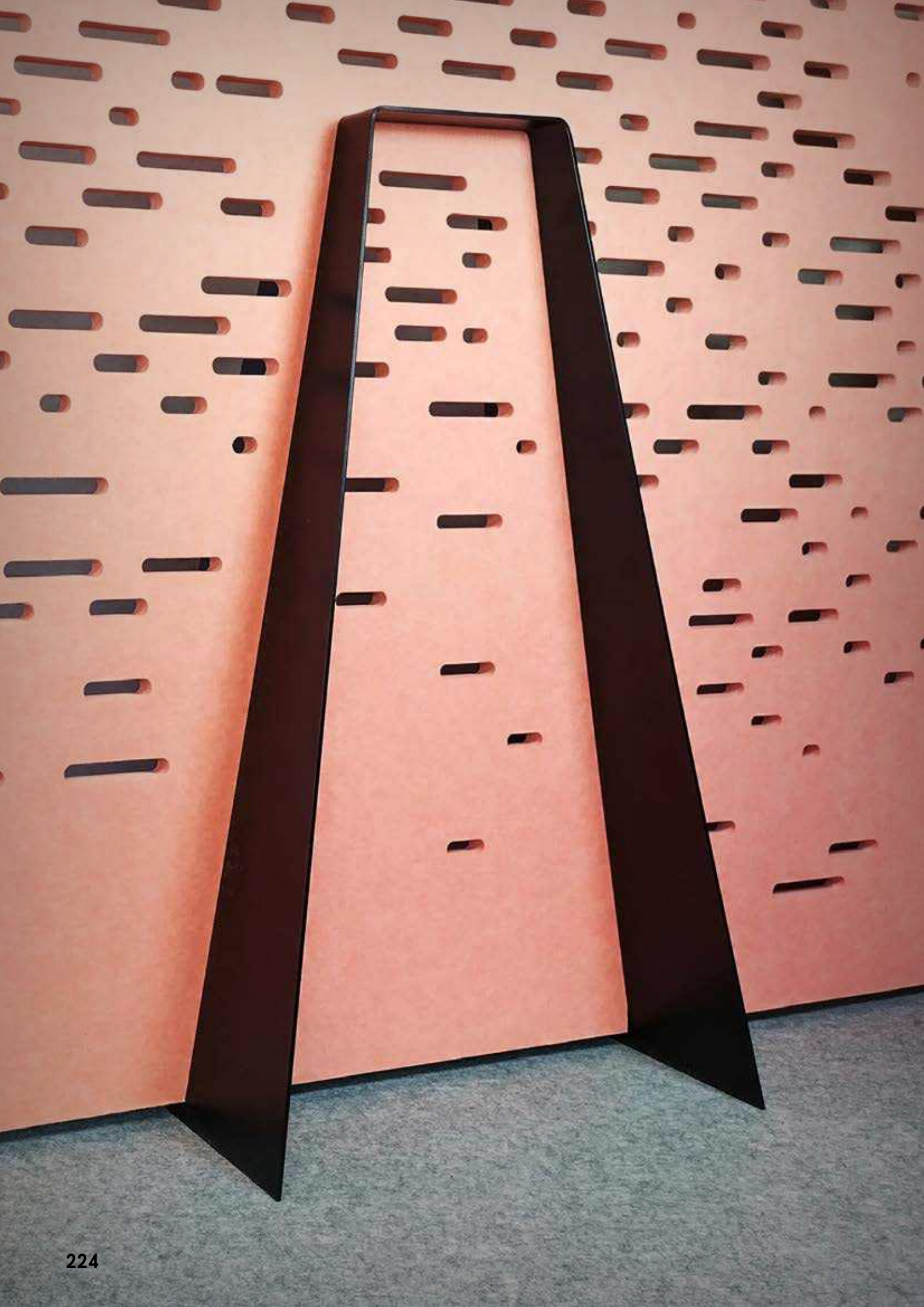

# ECHOCOVE® 24MM STAND CENTERBASE

High-quality steel base, available in three different designs, for the product EchoCove® 24mm STAND.

This article is part of the product EchoCove® 24mm STAND. ([Page 155](#))

BEZEICHNUNG	ARTIKEL	B x H x T (in mm)	EINHEIT	MATERIAL
FULL	1678-2	490x902x400	1 pce	Steel, powder-coated
SLIM	1678-3	490x902x413	1 pce	Steel, powder-coated
ARCH	1678-4	505x892x353	1 pce	Steel, powder-coated

**FULL**

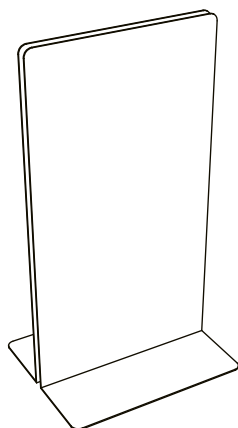

**SLIM**

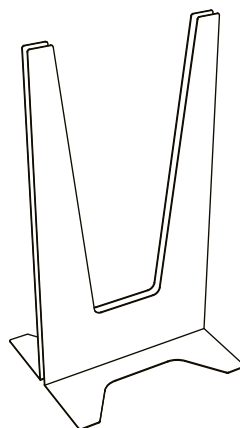

**ARCH**

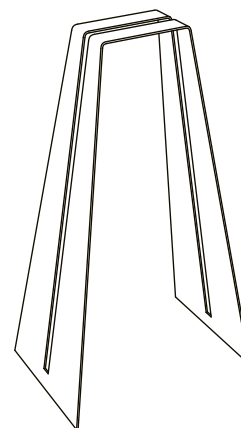

Our material can be very well customised. The large selection of colours is just the beginning. The surface can be cut, perforated or even printed on. Are you inspired by the EchoBoard® or another of our products? Don't hesitate to ask and maybe our design department already has a solution ready.



COMPANY PROFILE

MATERIAL

CEILING

LIGHTING

WALLS

PARTITIONS

FURNITURE

ADDITIONAL ITEMS

CREATE

**CREATE**



## COLOURS

Let yourself be inspired by our colourful selection of colours. The fibres dyed in a liquid state do not fade and are very colourfast. For larger projects, we will even be happy to create your personal colour shade.

# COLOURS

Due to the nature of the material, surface and colour deviations are possible.

You can always find the latest colour moods online at [www.echojazz.com/colours](http://www.echojazz.com/colours)

\*Discontinued. Colour available from stock while supplies last or on request with a minimum order quantity.



**105**  
SNOW



**111**  
MOUSE



**244**  
KOALA



**245**  
ASPHALT



**250**  
PANTHERA



**155**  
AQUA



**809**  
BEACH



**210**  
DRIFTWOOD



**204**  
MOCCA



**833**  
CAMEL



**133**  
HAZELNUT



**185**  
SIENNA



**185**  
CROCODILE



**975**  
OLIVE

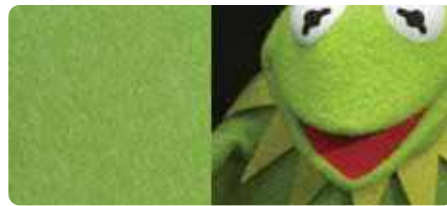

**263**  
KERMIT



**833**  
AVENTURINE



**133**  
FOREST



**563**  
DEEP



**784**  
BUBBLEGUM



**183\***  
LIME



**801\***  
SUNFLOWER



**592\***  
PUMPKIN



**852\***  
CHILI





COMPANY PROFILE

MATERIAL

CEILING

LIGHTING

WALLS

PARTITIONS

FURNITURE

ADDITIONAL ITEMS

CREATE

## ECHOGRID® CARVINGS

All products are cut to order at ECHO**JAZZ**. The possibilities for carvings are as individual as the sizes and shapes. In addition to your own pattern ideas or company logos, we also offer a current collection designed by our designers.

# ECHOGRID® CARVINGS 625

Carving designs for grid ceilings.

These Carving designs are options for EchoGrid® products. (Page 50)

**ECHOGRID®  
BALLOON**

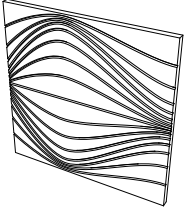

**ECHOGRID®  
CODE**

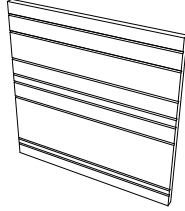

**ECHOGRID®  
DIAGONAL**

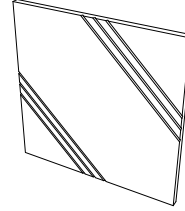

**ECHOGRID®  
FENCE**

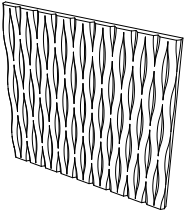

**ECHOGRID®  
FISHBONE**

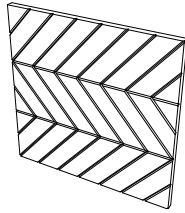

**ECHOGRID®  
FLOW**

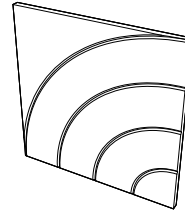

**ECHOGRID®  
FRAGMENTS**

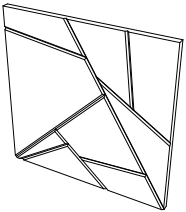

**ECHOGRID®  
KINGSCROSS**

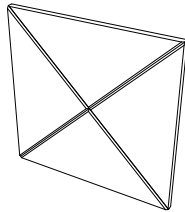

**ECHOGRID®  
LEAVES**

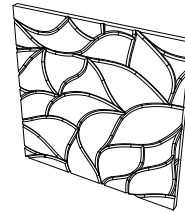

**ECHOGRID®  
SEAWEED**

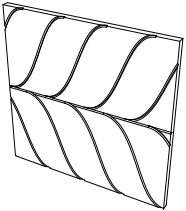

**ECHOGRID®  
SPHERE**

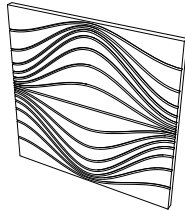

**ECHOGRID®  
STREAMS**

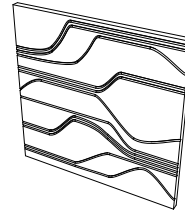

**ECHOGRID®  
TRAIL**

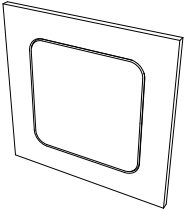

**ECHOGRID®  
VERTIGO**

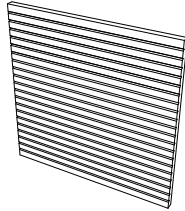

**ECHOGRID®  
WAVE**

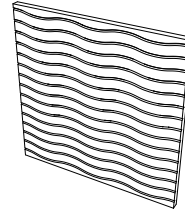

**ECHOGRID®  
WOVEN**

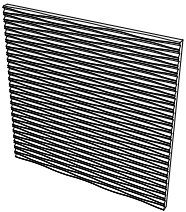

**ECHOGRID®  
ZIGZAG**

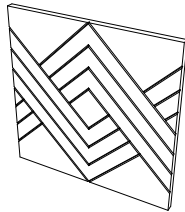

# ECHOGRID® CARVINGS 1250

Carving designs for grid ceilings.

These Carving designs are options for EchoGrid® products. (Page 50)

**ECHOGRID®  
BALLOON**

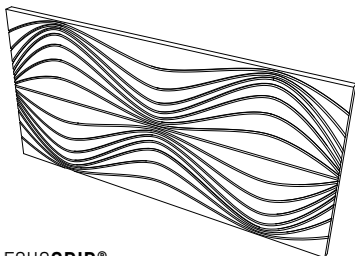

**ECHOGRID®  
CODE**

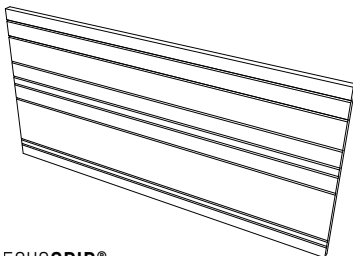

**ECHOGRID®  
DIAGONAL**

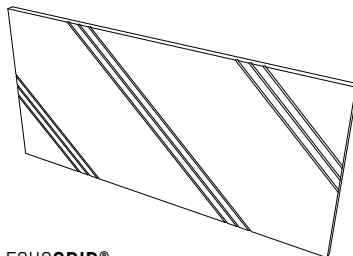

**ECHOGRID®  
FENCE**

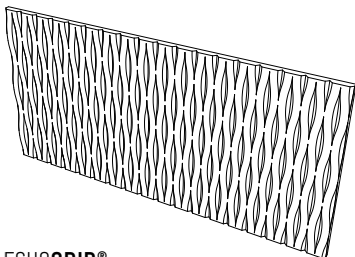

**ECHOGRID®  
FISHBONE**

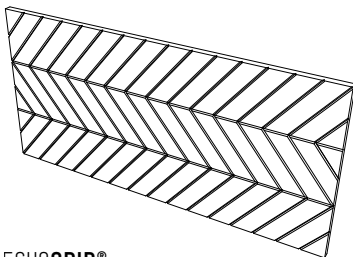

**ECHOGRID®  
FLOW**

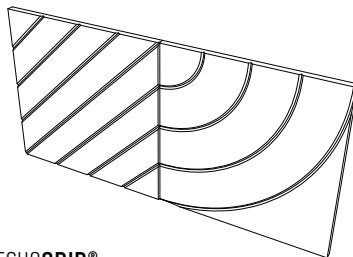

**ECHOGRID®  
FRAGMENTS**

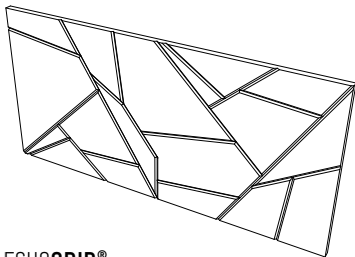

**ECHOGRID®  
KINGSCROSS**

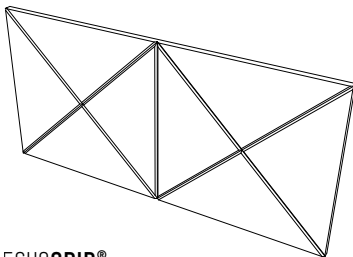

**ECHOGRID®  
LEAVES**

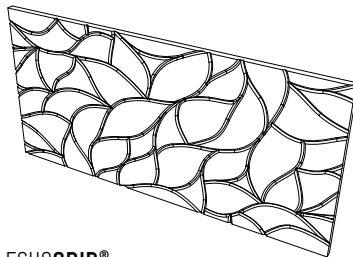

**ECHOGRID®  
SEAWEED**

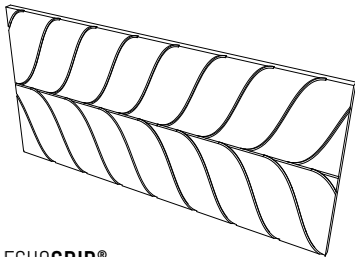

**ECHOGRID®  
SPHERE**

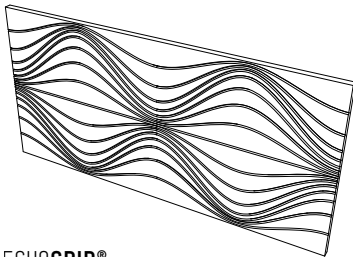

**ECHOGRID®  
STREAMS**

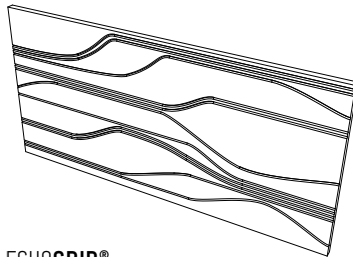

**ECHOGRID®  
TRAIL**

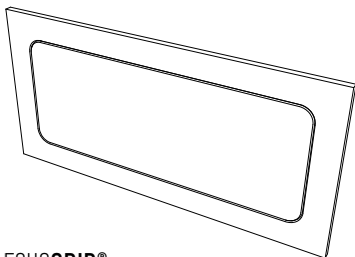

**ECHOGRID®  
VERTIGO**

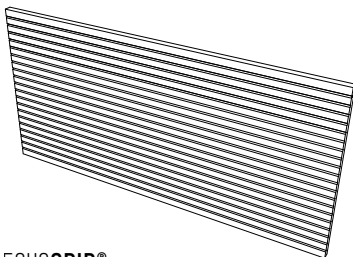

**ECHOGRID®  
WAVE**

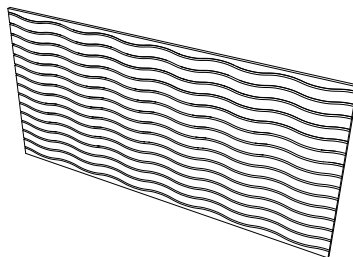

**ECHOGRID®  
WOVEN**

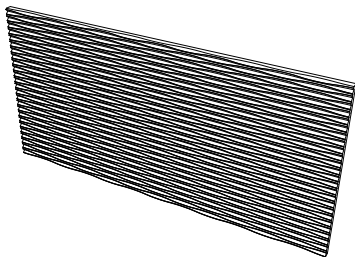

**ECHOGRID®  
ZIGZAG**

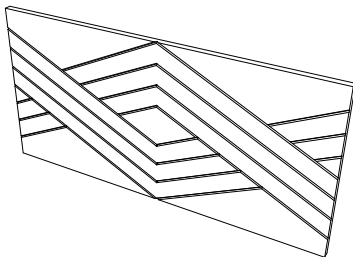





COMPANY PROFILE

MATERIAL

CEILING

LIGHTING

WALLS

PARTITIONS

FURNITURE

ADDITIONAL ITEMS

CREATE

## ECHOGRID® PERFORATIONS

All products are cut to order at ECHOJAZZ. The possibilities for perforation are as individual as the sizes and shapes. In addition to your own pattern ideas or company logos, we also offer a current collection designed by our designers.

# ECHOGRID® PERFORATIONS 625

Carving designs for grid ceilings.

These Carving designs are options for EchoGrid® products. (Page 50)

**ECHOGRID®  
ARC**

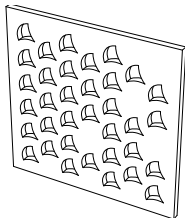

**ECHOGRID®  
BASILIKA**

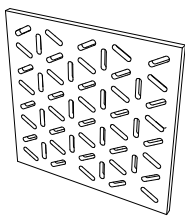

**ECHOGRID®  
BEAM**

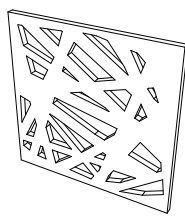

**ECHOGRID®  
BLOCKS**

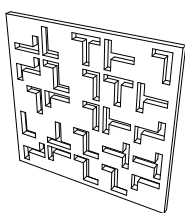

**ECHOGRID®  
CELTIC**

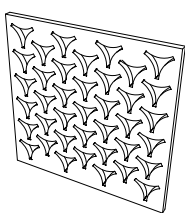

**ECHOGRID®  
CITY**

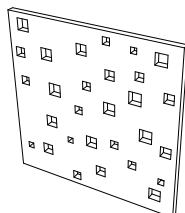

**ECHOGRID®  
CUBE**

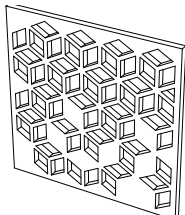

**ECHOGRID®  
GECKO**

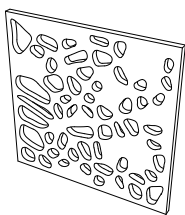

**ECHOGRID®  
MESH**

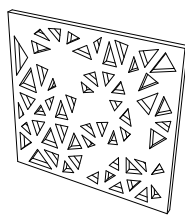

**ECHOGRID®  
PEN**

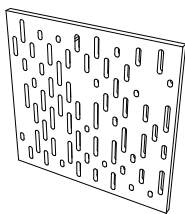

**ECHOGRID®  
PETALS**

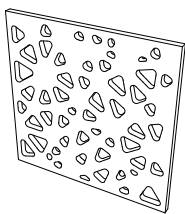

**ECHOGRID®  
PULL**

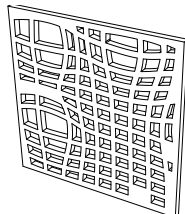

**ECHOGRID®  
SPARKLY**

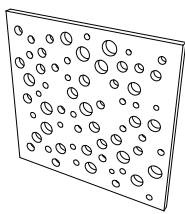

**ECHOGRID®  
SPIDER**

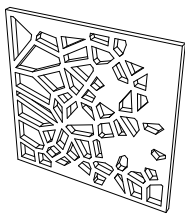

**ECHOGRID®  
ZEN**

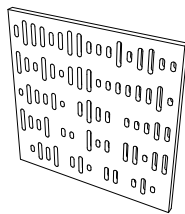

# ECHOGRID® PERFORATIONS 1250

Carving designs for grid ceilings.

These Carving designs are options for EchoGrid® products. (Page 50)

ECHOGRID®  
ARC

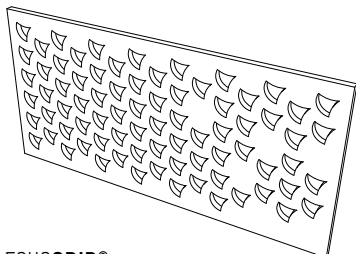

ECHOGRID®  
BASILIKA

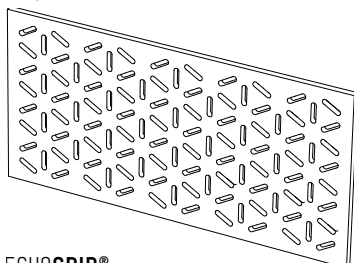

ECHOGRID®  
BEAM

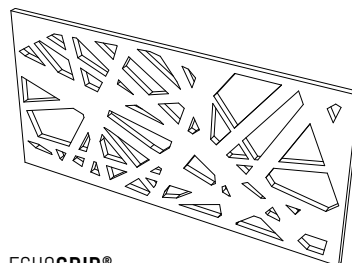

ECHOGRID®  
BLOCKS

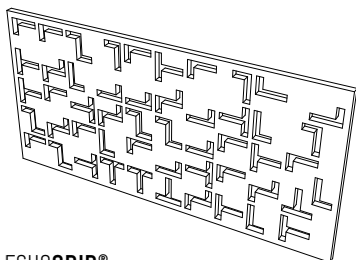

ECHOGRID®  
CELTIC

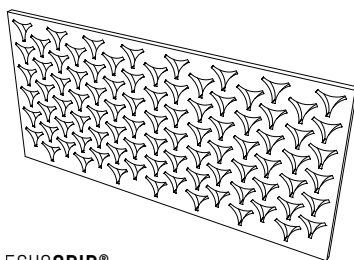

ECHOGRID®  
CITY

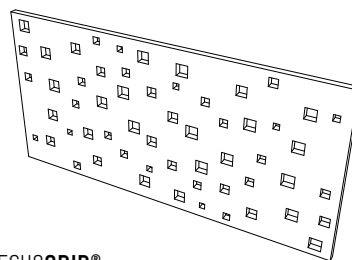

ECHOGRID®  
CUBE

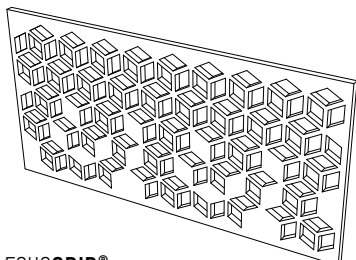

ECHOGRID®  
GECKO

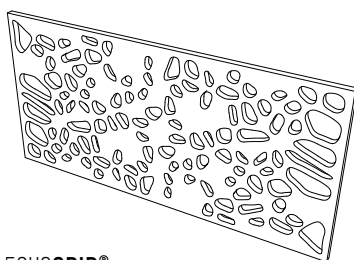

ECHOGRID®  
MESH

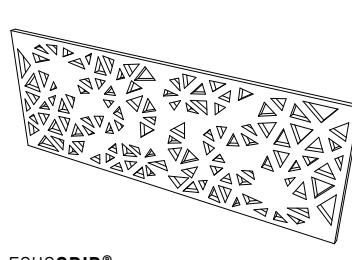

ECHOGRID®  
PEN

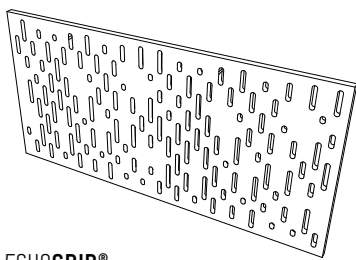

ECHOGRID®  
PETALS

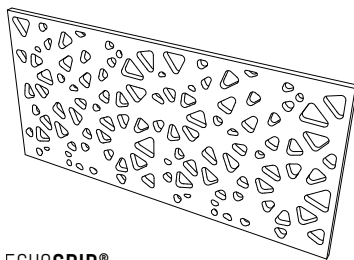

ECHOGRID®  
PULL

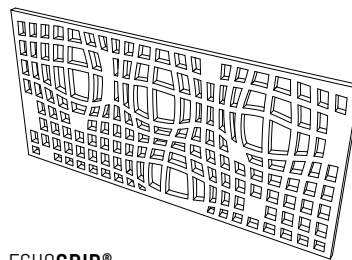

ECHOGRID®  
SPARKLY

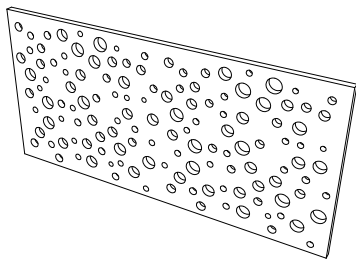

ECHOGRID®  
SPIDER

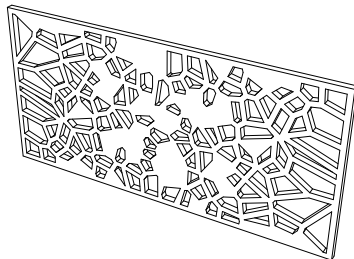

ECHOGRID®  
ZEN

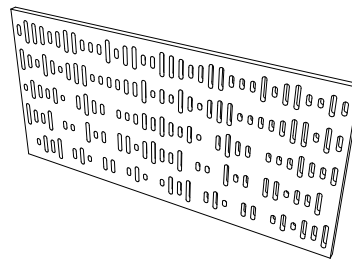

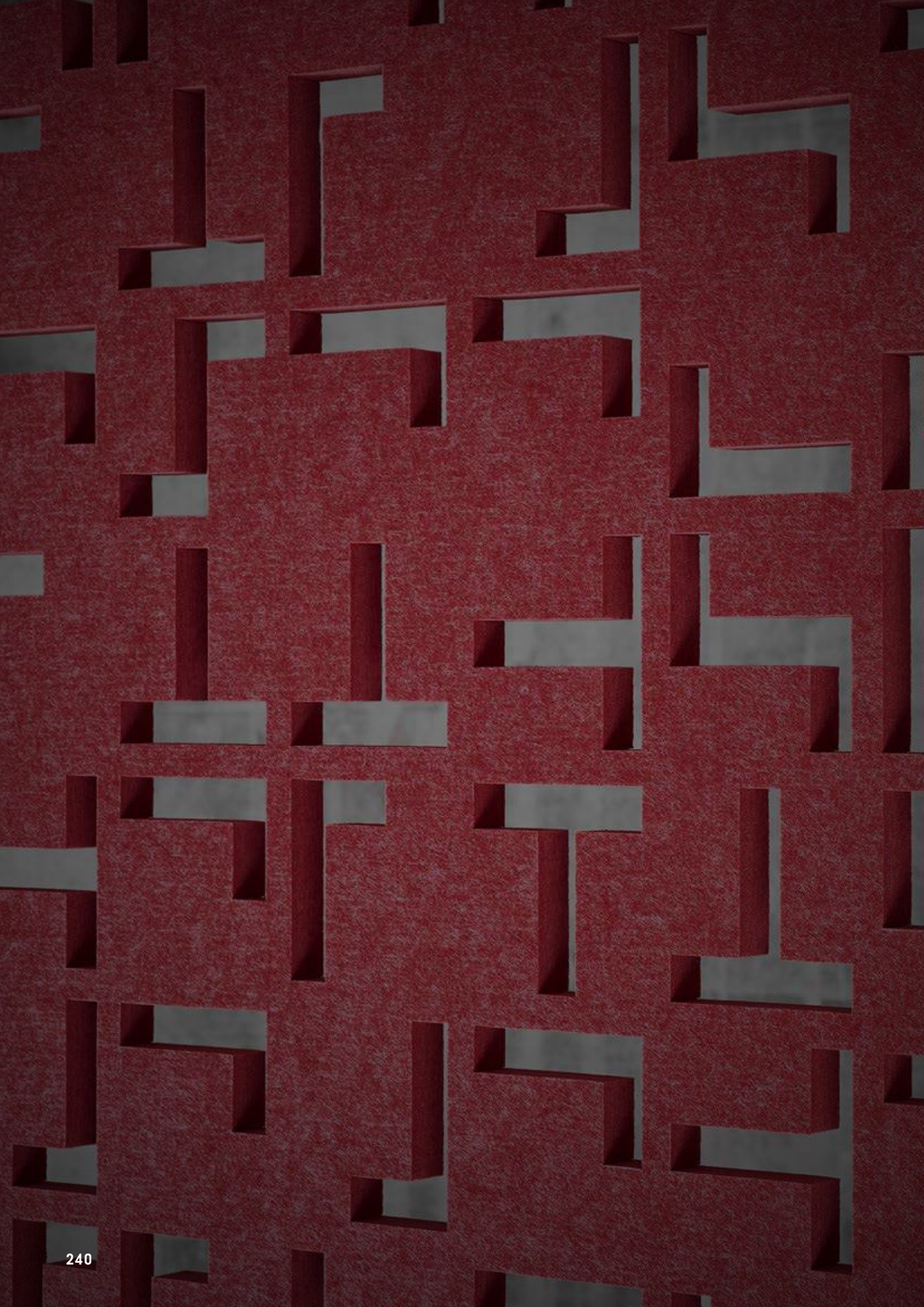



COMPANY PROFILE

MATERIAL

CEILING

LIGHTING

WALLS

PARTITIONS

FURNITURE

ADDITIONAL ITEMS

CREATE

## PERFORATIONS

All products are cut to order at ECHO**JAZZ**. The possibilities for perforation are as individual as the sizes and shapes. In addition to your own pattern ideas or company logos, we also offer a current collection designed by our designers.

# PERFORATIONS

Perforations as an additional option for various ECHOJAZZ products.

Special dimensions and designs on request

You can always find the latest designs online at [www.echojazz.com/perforations](http://www.echojazz.com/perforations)

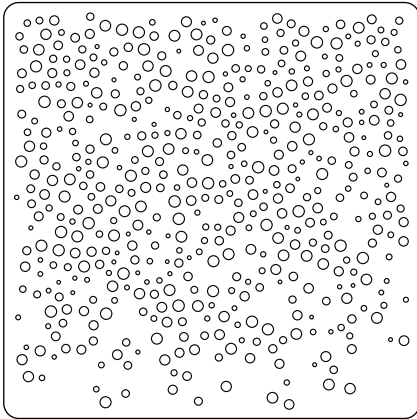

**SPARKLY - K**

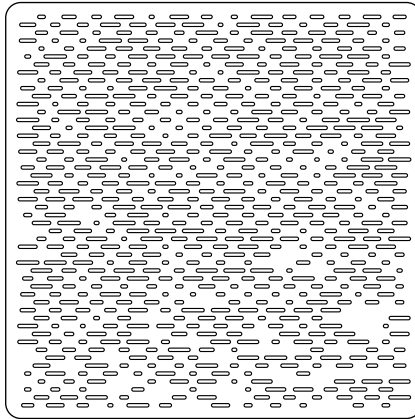

**PEN - L**

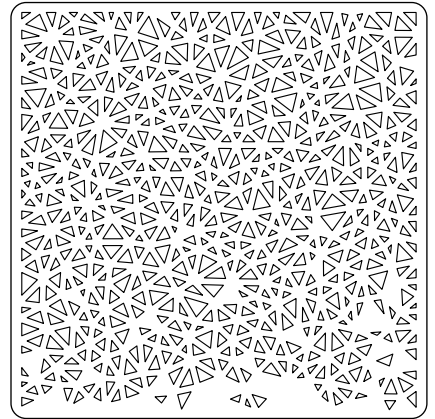

**MESH - M**

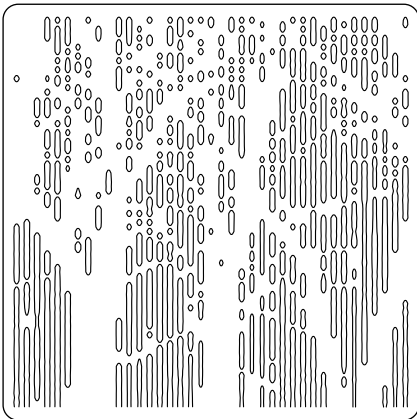

**JUNGLE - N**

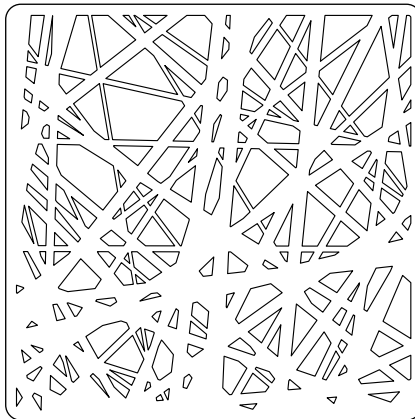

**BEAM - O**

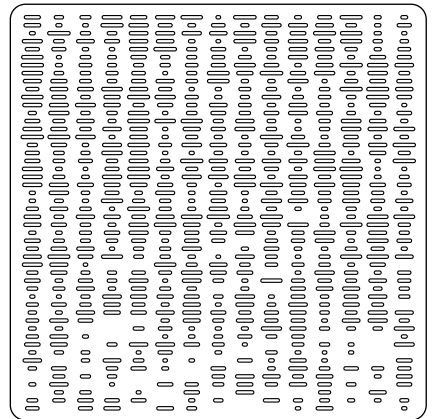

**ZEN - P**

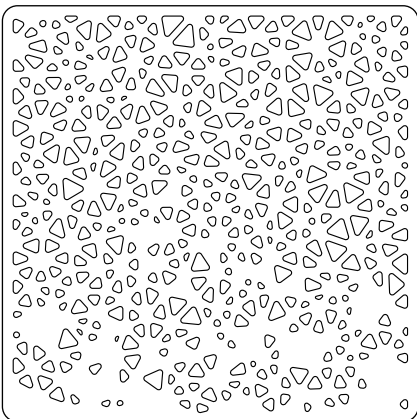

**PETALS - Q**

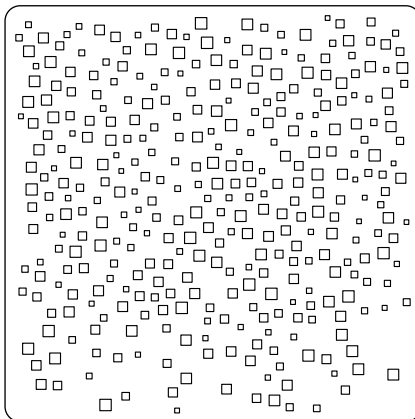

**CITY - R**

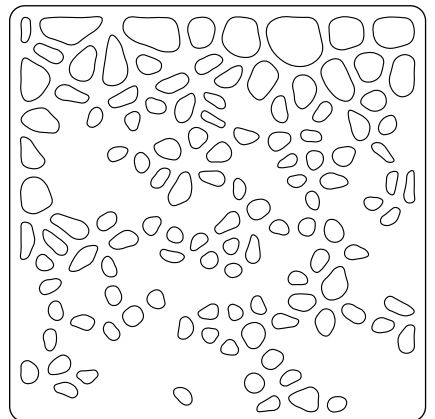

**GECKO - S**

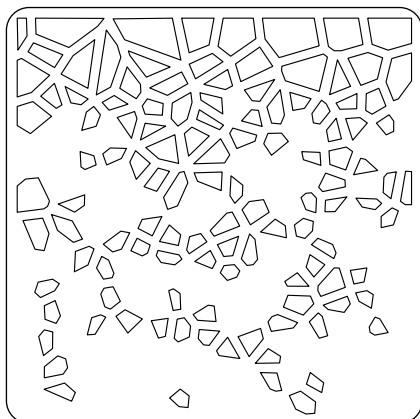

**SPIDER - T**

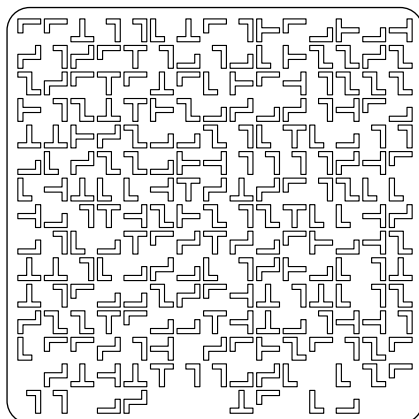

**BLOCKS - U**

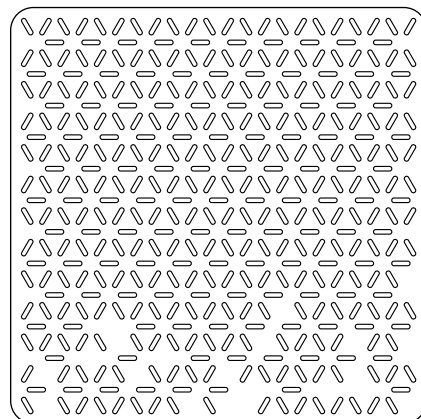

**BASILIKA - V**

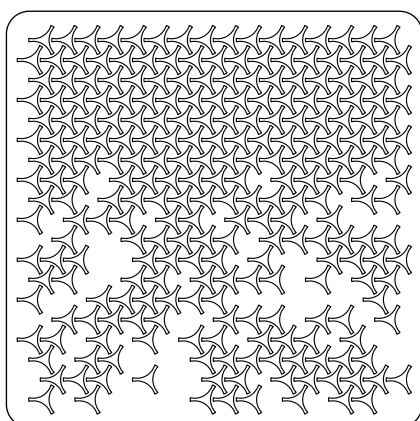

**CELTIC - W**

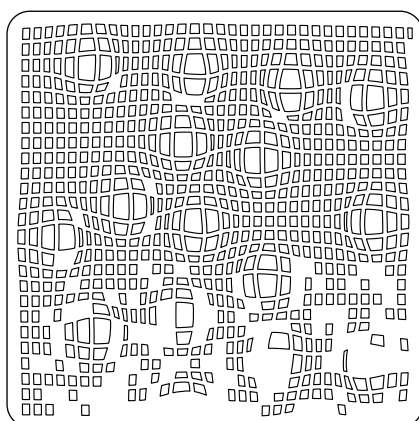

**PULL - X**

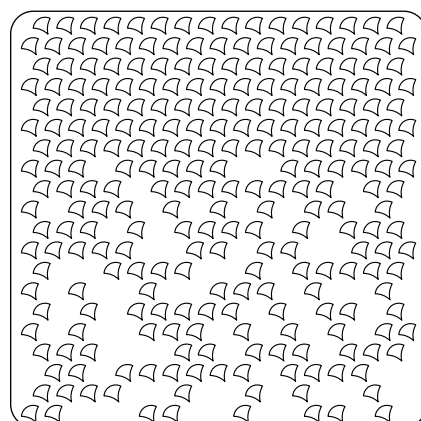

**ARC - Y**

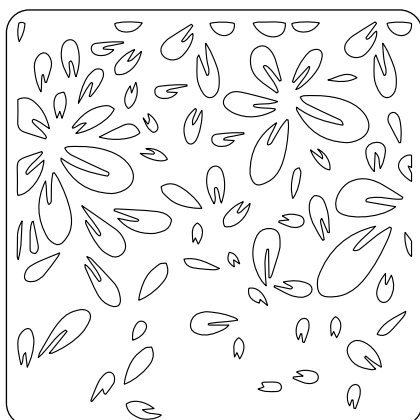

**FLOWERS - Z**

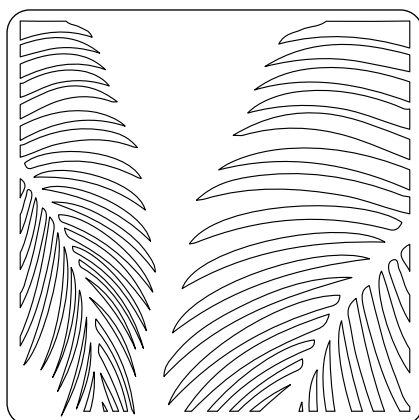

**PALM - AB**

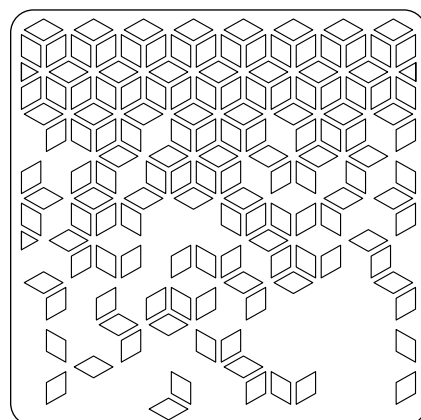

**CUBE - AC**



## SILHOUETTE

All products are cut to order at ECHO**JAZZ**. The possibilities for perforation are as individual as the sizes and shapes. In addition to your own pattern ideas or company logos, we also offer a current collection designed by our designers.

# SILHOUETTE

Silhouettes as an additional option for various ECHOJAZZ products.

Our SILHOUETTE designs are available with the product EchoCove® 24mm STAND 180 XL. [\(Page 152\)](#)

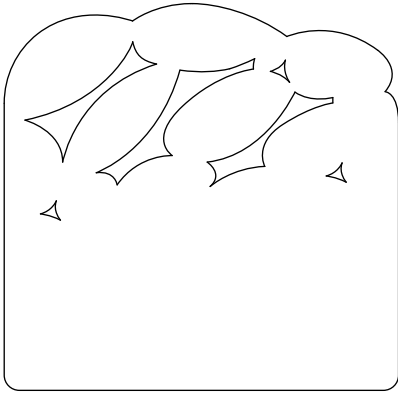

**ABSTRACT**

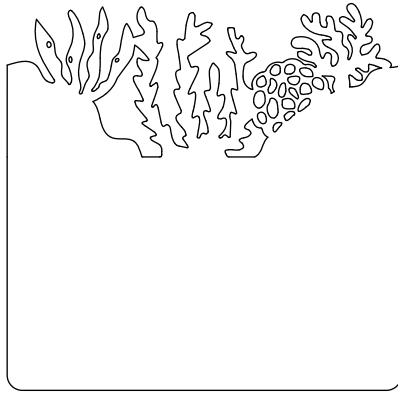

**CORAL**

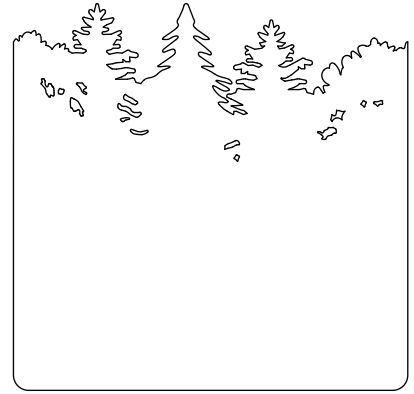

**FOREST**

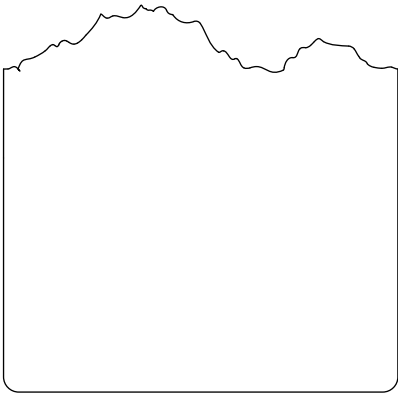

**MOUNTAIN**

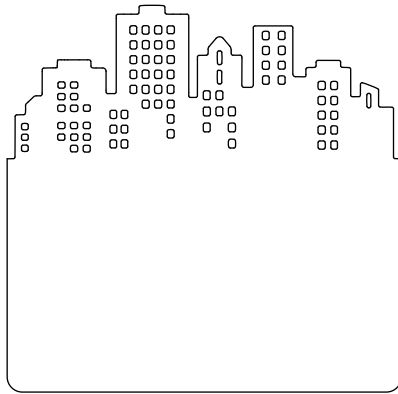

**SKYLINE**

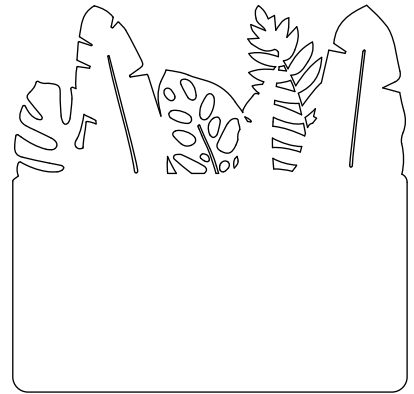

**TROPICAL**



COMPANY PROFILE

MATERIAL

CEILING

LIGHTING

WALLS

PARTITIONS

FURNITURE

ADDITIONAL ITEMS

CREATE



# ECHOJAZZ

**INSPIRED BY ACOUSTICS AND SUSTAINABILITY**

**100% PET ACOUSTIC ABSORBERS**

EN-20251125