

Architectural
elements

CO
AV
R
O



— A legacy of craftsmanship

1970 marked the birth of a vision. A vision of always innovating, always transforming. Pushing the boundaries of material science. From crafting ornate decor to pioneering technology materials in the industry, to Duropolymer.

From our genesis as Orac to our expansion into Orac Decor, our journey now brings us back to where it all began: Orac, coming full circle.



1970

Start of Ostend Research and Application Company

1980



Focus on decorative ornaments

1992



Introduction of flexible products

2000



Start of extrusion

2002



Second generation management

2010



Solar field and ISO14001 certification

2012



Modern concept

UA —

1970 рік став початком нової філософії. Бачення нових інновацій, потреба в трансформації, розширення меж науки про матеріали. Понад п'ятдесят років наше прагнення до інновацій вело нас від створення вишуканого декору до новаторства в галузі технологічних матеріалів та розробки Duropolymer. Ми завжди прагнемо поєднати довговічність з новаціями. Кожного року, ми — в Orac, — виходили за межі власної ідентичності. Наша подорож, яка почалася від заснування Orac до розширення в Orac Decor, замикає коло й повертає нас туди, де все почалося: до Orac. Ми не просто виробники декору — ми першопрохідці, візjonerи, дизайнери простору.

PL —

Rok 1970 był rokiem narodzin wizji. Wizja ciągłego wprowadzania innowacji, ciągłego przekształcania. Przesuwanie granic nauk o materiałach. Od ponad pięćdziesięciu lat nasza pasja do innowacji napędza nas do tworzenia ozdobnych dekoracji z pionierskich materiałów technologicznych w branży przemysłu na duropolimery. Zawsze szukamy tego, co trwałe i napędzane rewolucją. Z każdym obrotem kalendarza my – w Orac – przekraczamy naszą pierwotną tożsamość. Od naszej genezy jako Orac do naszej ekspansji na Orac Decor, nasza podróż prowadzi nas teraz z powrotem do miejsca, w którym wszystko się zaczęło: Orac zatacza koło. Jesteśmy czymś więcej niż rzemieślnikami dekoracji; jesteśmy pionierami, wizjonerami, gawędziarzami wewnątrz.

RO —

Anul 1970 a marcat nașterea unei viziuni. O viziune de a inova mereu, de a transforma mereu. Depășind limitele științei materialelor. Timp de peste cincizeci de ani, pasiunea noastră pentru inovație ne-a condus de la fabricarea de decorațiuni ornamentale până la materiale tehnologice de pionierat în industrie la Duropolymer. Căutând întotdeauna să îmbinăm ceea ce este durabil cu ceea ce este revoluționar. Cu fiecare întoarcere a calendarului, noi - la Orac - am depășit identitatea noastră inițială. De la geneza noastră ca Orac până la extinderea noastră în Orac Decor, călătoria noastră ne aduce acum înapoi la locul unde a început totul: Orac, întorcându-ne la cercul complet. Suntem mai mult decât artizani ai decorului; suntem pionieri, vizionari, naratori ai spațiului.

CZ —

Rok 1970 znamenal zdroj vize. Vize stále inovovat, neustále se transformovat. Posouvání hranic materiálové vědy. Již více než padesát let naši vášně pro inovacénás vedlo od výroby ozdobných dekorací k průkopnickým technologickým materiálům v průmyslu až k Duropolymeru. Vždy jsme se snažili spojit trvalé s revolučním. S každým otočením kalendáře jsme – v Oracu – překročili naši původní identitu. Od našeho zrodu jako Orac po naše rozšíření na Orac Decor, naše cesta nás nyní přivádí zpět tam, kde to všechno začalo: Orac, kruh se uzavírá. Jsme víc než jen výrobci dekorací; jsme průkopníci, vizionáři a vypravěči příběhů o interiéru.

ORAC

We shed our old skin — Orac Decor — to emerge simply as Orac, a name that encapsulates our essence and our expansive vision for the future.

At Orac, we've always believed that there are many sides to a wall, and we are committed to choosing the good one. In a world where design often feels transient, we've chosen a different path.



Sustainability goes beyond the use of recycled materials; it's about designing ideas that stand the test of time. We understand that true sustainability means creating products that remain relevant for generations, not just a few fleeting years.



— A
commitment
carved in
walls

UA —

В Орас ми завжди вірили, що у стіни є багато сторін, і ми прагнемо обрати найкращу з них. У світі, де дизайн часто здається швидкоплинним, ми обрали інший шлях. Екологічність - це не тільки про використання перероблених матеріалів; це про розробку ідей, які витримують випробування часом. Ми розуміємо, що справжня сталість - це створення продуктів, які залишатимуться актуальними протягом поколінь, а не лише кількох швидкоплинних років.

RO —

La Orac, am fost dintotdeauna de părere că un perete are mai multe fațete și depunem toate eforturile pentru a o alege pe cea mai bună. Într-o lume în care designul are de multe ori o dimensiune trecătoare, noi am ales o cale diferită. Sustenabilitatea nu înseamnă doar folosirea de materiale reciclate, ci înseamnă să concepem idei care nu-și pierd valoarea cu trecerea timpului. Înțelegem faptul că sustenabilitatea adevărată înseamnă să creăm produse care continuă să fie relevante pentru generațiile viitoare, nu doar pentru câțiva ani.

PL —

W Orac wierzymy, że ściany mają wiele stron i jesteśmy zobowiązani do wybierania tej dobrej. W świecie, w którym design często wydaje się przemijający, wybraliśmy inną ścieżkę. Zrównoważony rozwój wykracza poza wykorzystywanie materiałów pochodzących z recyklingu; chodzi o projekty, które przetrwają próbę czasu. Rozumiemy, że prawdziwy zrównoważony rozwój oznacza tworzenie produktów, które pozostają aktualne dla wielu pokoleń, a nie będą dekoracją tylko przez kilka ulotnych lat.

CZ —

Ve společnosti Orac jsme vždy věřili, že stěna má mnoho stran, a rozhodli jsme se vybrat si tu dobrou. Ve světě, kde design často působí pomíjivě, jsme si zvolili jinou cestu. Udržitelnost přesahuje používání recyklovaných materiálů; jde o designové záměry, které obstojí ve zkoušce času. Chápeme, že skutečná udržitelnost znamená vytvářet produkty, které zůstanou relevantní pro celé generace, nikoliv jen pro několik pomíjivých let.



— Every wall is a blank canvas



Where others see a flat surface, we see a world of possibilities. A clean primer, waiting for a little intervention. A bare base, in need of shape and dimension. A neutral support, asking to be someone's project and the centre of their attention. Which is all why, at Orac, we like to say we're visual artists of sorts — taking walls as a field of experimentation and at any time, seeking to honour their unique creative potential.

UA —

Там, де інші бачать рівну поверхню, ми вбачаємо світ можливостей. Це чисте полотно, яке чекає на свого митця. Проста основа, яка потребує форм та об'єму, невизначна, але з правильним підходом може стати витвором мистецтва та привернути увагу оточуючих. Саме тому, в компанії Orac, ми вважаємо себе свого роду візуальними художниками - сприймаємо стіни, як поле для експериментів, і прагнемо реалізувати їх унікальний творчий потенціал.

PL —

Tam, gdzie inni widzą płaską powierzchnię, my widzimy świat możliwości. Czysty podkład, czekający na małe zmiany. Kanwa, która potrzebuje, aby nadać jej kształtu i przestrzenności. Neutralne podłoże, które rwie się, aby stać się czymś projektem i być w centrum uwagi. Dlatego w Orac lubimy mówić, że jesteśmy pewnego rodzaju artystami wizualnymi - traktujemy ściany jako pole do eksperymentów i w każdej chwili staramy się uhonorować ich wyjątkowy potencjał twórczy.

RO —

Unde alții văd doar o suprafață plană, noi vedem posibilități nenumărate. Un grund curat, ca o pânză care așteaptă doar intervenția pictorului. O bază simplă, care are nevoie doar de formă și dimensiune. Un suport neutru, care abia așteaptă să devină, pentru cineva, un proiect de suflet și centrul atenției. Iată de ce, la Orac, ne place să spunem despre noi că suntem, într-un fel, artiști vizuali. Peretii sunt, pentru noi, o suprafață cu care ne putem „juca” și apreciem potențialul lor creativ unic.

CZ —

Tam, kde ostatní vidí hladký povrch, my vidíme svět možností. Čistý podklad, který čeká na malý zásah. Holý základ, který potřebuje tvar a rozměr. Neutrální základ, který chce být něčím projektem a středem pozornosti. Ve společnosti Orac proto rádi říkáme, že jsme svým způsobem vizuální umělci – bereme stěny jako prostor pro experimentování a v každém okamžiku se snažíme cítit jejich jedinečný tvůrčí potenciál.





Whether it's a touch of the contemporary or a nod to the classics, each of our products is a chameleon, adept at taking on the character you desire. Here are some glimpses into the myriad of ways our products can animate, define and transform interiors.

Every setting, every angle reveals new potential. A new story to be told.

Unexpected possibilities

UA —

Незалежно від того, чи це дотик до сучасності, чи погляд у сторону класики, кожен наш продукт — це хамелеон, який допоможе створити бажаний ефект. Ми хочемо з вами поділитися незліченною кількістю варіантів того, як наша продукція може надавати характеру, оживляти та видозмінювати простір. Кожне місце, кожен куток розкриває новий потенціал. Нову історію, яку ми хочемо розповісти.

PL —

Niezależnie od tego, czy chodzi o odrobinę współczesności, czy o ukłon w stronę klasyki, każdy z naszych produktów jest kameleonem, który potrafi wywrzeć pożądany efekt. Z przyjemnością prezentujemy niezliczone możliwości, dzięki którym nasze produkty mogą ożywiać, definiować i przekształcać przestrzenie. Każde ustawienie, każdy kąt ujawnia nowy potencjał. Nowa historia, którą chcemy opowiedzieć.

RO —

Fie că este vorba de o tușă contemporană sau de o trimitere la stilul clasic, fiecare dintre produsele noastre este cameleonice, adoptând cu ușurință caracterul dorit de dvs. Ne face plăcere să ilustrăm multitudinea de modalități în care produsele noastre pot aduce la viață interioarele, în care le pot defini și transforma. Fiecare loc, fiecare unghi este încărcat de potențial. Este o nouă poveste care abia așteaptă să fie spusă.

CZ —

Každý z našich produktů je chameleonem, který dokáže převzít charakter, jaký si přejete, ať už se jedná o nádech moderny nebo klasiky. Rádi vás seznámíme s nespočty způsoby, jakými mohou naše produkty oživit, definovat a proměnit prostor. Každé prostředí, každý úhel pohledu odhaluje nový potenciál. Nový příběh, který je třeba vyprávět.

Content

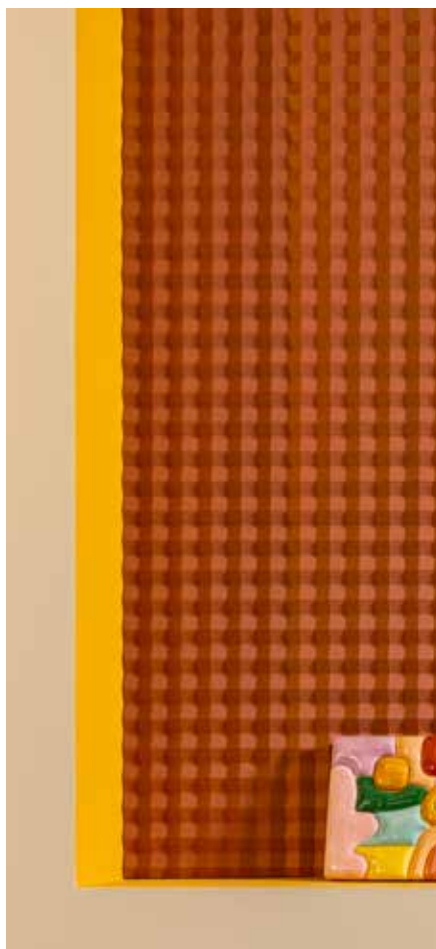

EN –

9 Unexpected possibilities

- 12 About today
- 22 Uncut modern
- 32 Vibrant allure
- 44 Essential still

57 Products

- 58 Materials
- 62 Product Overview
- 64 — 01 Cornice mouldings
- 94 — 02 3D Wall covering
- 110 — 03 Skirting boards
- 124 — 04 Panel mouldings
- 136 — 05 Indirect lighting
- 152 — 06 Deco elements
- 162 — 07 The perfect finish
- 166 — 08 Flexible products

UA –

9 Несподівані можливості

- 12 Про сьогоднішнє
- 22 Нерозрізаний модерн
- 32 Яскрава принада
- 44 Все ще значущі

57 Продукція

- 58 Матеріали
- 62 Огляд продукції
- 64 — 01 Карнизи
- 92 — 02 Стінові 3D-панелі
- 108 — 03 Плінтуси
- 122 — 04 Молдинги
- 134 — 05 Профілі для LED-освітлення
- 148 — 06 Декоративні елементи
- 158 — 07 Бездоганий результат
- 162 — 08 Гнучкі профілі



PL –

9 Nieoczekiwane możliwości

- 12 O dzisiaj
- 22 Nieskazitelna nowoczesność
- 32 Wibrujący urok
- 44 Nadal niezbędny

57 Produkty

- 58 Materiały
- 62 Przegląd Produktów
- 64 — 01 Gzymsy
- 92 — 02 Panele 3D
- 108 — 03 Listwy przypodłogowe
- 122 — 04 Profile ścienne
- 134 — 05 Listwy oświetleniowe
- 148 — 06 Elementy dekoracyjne
- 158 — 07 Idealne wykończenie
- 162 — 08 Produkty elastyczne

RO –

9 Posibilități neașteptate

- 12 Despre prezent
- 22 Modernitate neșlefuită
- 32 Un farmec plin de viață
- 44 Încă esențiale

57 Produse

- 58 Materiale
- 62 Rezumatul produselor
- 64 — 01 Cornise
- 92 — 02 Panouri decorative 3D
- 108 — 03 Plinte
- 122 — 04 Brauri
- 134 — 05 Iluminat indirect
- 148 — 06 Elemente decorative
- 158 — 07 Finisarea perfecta
- 162 — 08 Produse flexibile

CZ –

9 Nečekané možnosti

- 12 O dnešní době
- 22 Moderna bez stříhu
- 32 Živý půvab
- 44 Stále to podstatné

57 Produkty

- 58 Materiály
- 62 Přehled produktů
- 64 — 01 Stropní lišty
- 92 — 02 3D Nástěnné obložení
- 108 — 03 Podlahové lišty
- 122 — 04 Lemovací lišty
- 134 — 05 Nepřímé osvětlení
- 148 — 06 Dekoratívni Prvky
- 158 — 07 Perfektní Zakončení
- 162 — 08 Ohebné Produkty

About today

At times, the modern is inclined to the here and now. Freed from the transience of fashion, it reveals a classic for the future. We are delighted to see it happen. The legacy of an era is revisited to create something new.

UA –

Іноді сучасність тяжіє до сьогодення. Звільнившись від швидкоплинності моди, відкривається майбутнє до класики. Ми раді за цим спостерігати. Спадщина епохи перероджується, щоб створити щось нове. Нота сміливості в знак поваги до сьогодення і майбутнього.

RO –

Uneori, spiritul modern tinde spre momentul prezent. Eliberat de caracterul temporar al modei, aceasta devine un clasic al viitorului. Suntem cu adevărat încântați când asistăm la acest proces. Moștenirea unei epoci este reinterpretată pentru a crea ceva nou. O notă temerară, un omagiu adus prezentului și viitorului.

PL –

Czasami to, co jest nowoczesne, wpisuje się w obecną epokę. Nowoczesność uwolniona od ulotnej natury mody, odsłania ponadczasową esencję na przyszłość. Cieszymy się, że możemy być świadkami tego zjawiska.

Dziedzictwo epoki powraca, aby stworzyć coś innowacyjnego. Odważny gest oddaje hołd zarówno teraźniejszości, jak i przyszłości.

CZ –

Modernost se občas přiklání k proudu. Osvobozena od pomíjivosti módy odhaluje klasiku pro budoucnost. Jsme rádi, že se to děje. Znovu se vracíme k odkazu jedné éry, abychom vytvořili něco nového. Odvážný dotek vzdávající hold současnosti a zítřku.



1. **C990** p.77 2. **CX188** p.146 3. **PX209** p.133 4. **W217** p.101 5. **W218** p.101 6. **SX182** p.113

UA —
Білий, в поєднанні з основними
кольорами, — смілива та
контрастна взаємодія.

PL —
Biel spotyka się z podstawowymi
kolorami: odważna, kontrastowa gra.

RO —
Albul se îmbină cu culorile primare:
o interacțiune îndrăznească, un joc
al contrastelor.

CZ —
Bílá se setkává v odvážné a kontrastní
soubře se základními barvami.

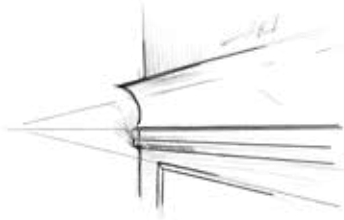

C990 INFINITY + CX188



1. C990 p.77 2. CX188 p.146 3. PX209 p.133

3. PX209 p.133



White meets
primary colours:
a bold, contrasting
interplay.

UA —
Великі 3D-форми створюють
сміливий та естетичний простір.

PL —
Duże kształty 3D odważnie
tworzą estetykę przestrzeni.

RO —
Formele tridimensionale voluminoase
crează un interior cu caracteristici
îndrăznețe.

CZ —
Velké 3D tvary vytvářejí
odvážně estetický prostor.

¹ **W115** p.104



Large 3D shapes
carve out a boldly
aesthetic space.



W218 QUILT

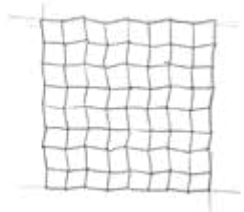

W115 SLOPE



About today

2. W218 p.101 3. W217 p.101 4. SX182 p.113

The Hub

GHENT (BE)

Project

ORAC



1. CX190 | CX190F p.146 2. SX194 | SX194F p.133 3. W114 | W114F p.100

UA —
Еклектичне поєднання округлих 3D-панелей та яскравих кольорових контрастів.

PL —
Eklektyczne połączenie zaokrąglonych paneli 3D i żywych kontrastujących barw.

RO —
Un amestec eclectic de panouri tridimensionale rotunjite și contraste cromatice puternice.

CZ —
Eklektická směs zaoblených 3D panelů a výrazných barevných kontrastů.

Eclectic blend of rounded 3D panels and vivid colour contrasts.

¹ CX190 | CX190F p.146 ² SX194 | SX194F p.133 ³ W114 | W114F p.100



Each room a vibrant canvas with 3D textured walls, daringly immersive. We invite you to dive in and explore.



1. W110 p.98

1. W110 p.98



UA —
Кожна кімната — це яскраве полотно з 3D-текстурними стінами, які зухвало занурюють у свою атмосферу. Запрошуємо вас зануритись разом із нами.

PL —
Każdy pokój to tętniące życiem płótno z teksturowanymi ścianami 3D, odważnie immersyjne. Zachęcamy do wkroczenia do naszego świata, jeśli tylko tego zapragniesz.

RO —
Camerile se transformă în tot atâtea pânze cu pereți tridimensionali texturați, care creează o atmosferă captivantă. Vă invităm să pătrundeți în acest univers, dacă vă doriți aceasta.

CZ —
Každá místnost je živým plátnem s 3D texturou na stěnách, které vás odvážně pohltí. Pokud chcete, můžete se ponořit.

1. W110 p.98



Uncut modern

UA —

Нас постійно вражають унікальні досягнення сучасності. Прогресивність розуму. Спосіб, у який скромність поєднується з тонкою величчю. Ми з любов'ю створюємо чисті лінії, цінуємо мінімалістичний шарм і бруталну зухвалість. Любов до сучасності спонукає нас бути уважними до деталей.

RO —

Realizările unice ale epocii moderne ne-au impresionat întotdeauna și continuă să o facă. Progresul gândirii. Felul în care se îmbină simplitatea cu măreția subtilă. Trasăm cu delicatețe linii curate, admirăm grația minimalismului și estetica brutalismului. Pasiunea noastră pentru modernitate ne îndeamnă să fim mereu atenți la detalii.

PL —

Nieustannie inspirują nas wyjątkowe osiągnięcia współczesności – postępowość umysłu, harmonijne połączenie skromności z subtelną wielkością. Z lubością śledzimy czyste linie, stawiamy na minimalistyczny wdzięk i doceniamy brutalistyczną śmiałość. Nasze przywiązanie do nowoczesności sprzyja dbałości o szczegóły.

CZ —

Neustále nás dojmají výjimečné úspěchy moderní doby. Progresivita mysli. Způsob, jakým se skromnost snoubí s jemnou vznešeností. S láskou sledujeme čisté linie, oceňujeme minimalistický půvab a brutalistní odvahu. Naše slabost pro modernost podporuje naši pozornost věnovanou detailům.

We are perpetually moved by the singular achievements of the modern age. The progressiveness of the mind. The way modesty blends with subtle grandeur. We lovingly trace clean lines, value minimalist grace and brutalist audacity. Our affection for modernity encourages our attentiveness to detail.



UA —

Плавні лінії, кутові форми та мінімалістична елегантність у сучасній гармонії.

PL —

Smukle linie, kanciaste kształty i minimalistyczna elegancja w pełnej harmonii.

RO —

Linii curate, forme unghiulare și eleganță minimalistă, toate se contopesc pentru a crea armonia modernă.

CZ —

Elegantní linie, hranaté tvary a minimalistická elegancie v moderní harmonii.

Sleek lines, angular shapes and minimalist elegance in modern harmony.

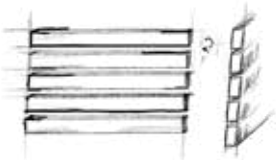

W111 BAR



- 4 C391 p.79
- 5 C393 p.79
- 6 W111 p.103
- 7 W116 p.103
- 8 W119 p.103
- 9 CX190 p.118



1. **C391** p.79
2. **C393** p.79
3. **CX190** p.133
4. **W216** p.104
5. **SX207** p.120

UA —
Сучасна атмосфера арт-деко
— це стримана, багатшарова
елегантність.

PL —
Nowoczesny klimat art deco:
subtelna, wielowarstwowa elegancja.

RO —
Influențe art deco moderne: elegantă
subtilă, care se dezvăluie treptat.

CZ —
Moderní atmosféra Art Deco:
nenápadná, vrstvená elegancie.

Modern Art Deco vibe:
an understated,
layered elegance.

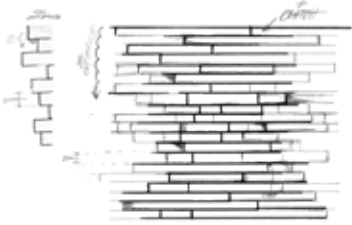

W216 MATRIX

7. C392 p.79 8. C390 p.79 9. P7070 p.128 10. SX180 p.116

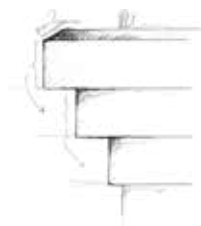

P7070



¹ CX190 p.118

Symmetry
reimagined:
U-profiles dance on
walls and gracefully
embrace ceilings.

Unexpected possibilities

UA —

Переосмислена симетрія: U-подібні профілі танцюють на стінах і витончено обіймають стелю.

PL —

Symetria w nowej odsłonie: Profile w kształcie litery U tańczą na ścianach i wdzięcznie otulają sufity.

RO —

Simetrie reinventată: profiluri în U care pun în valoare pereții și care evidențiază elegant plafoanele.

CZ —

Symetrie v novém pojetí: U-profilý tančí na stěnách a ladně objímají stropy.



² CX190 | CX190F p.118



² CX190F p.119



1. SX180 p.116

Stepped lines
translate a modern
Art Deco vision from
floor to ceiling.

1. SX180 p.116 2. CX188 p.146 3. C393 p.79 4. C394 p.79 5. C391 p.79

UA —
Ступінчасті лінії передають сучасне бачення ар-деко від підлоги до стелі.

PL —
Schodkowe linie wyrażają nowoczesną wizję art deco od podłogi po sufit.

RO —
Linile care formează trepte ilustrează viziunea art deco pe verticală, de la pardoseală până la plafon.

CZ —
Stupňovité linie odrážejí moderní vizi Art Deco od podlahy až ke stropu.





⁶. C991 + 2xP9900 p.77 ⁷. CX188 p.146

Vibrant allure

UA —

Ми любимо занурюватися у світ мистецьких сюрпризів, де класична елегантність поєднується зі сміливими, зухвалими поворотами, створюючи неповторний досвід. Царство несподіванок, де вишуканість зустрічається з примхами на святі творчості.

PL —

Pragniemy zanurzyć się w świecie artystycznych niespodzianek, w którym klasyczna elegancja spotyka się z odważnymi, bezkompromisowymi zwrotami akcji, tworząc jedyne w swoim rodzaju doznanie. To królestwo nieoczekiwanego, gdzie elegancja spotyka się z fanaberią w imię kreatywności.

RO —

Ne face plăcere să pătrundem într-un univers plin de surprize ingenioase, în care stilul clasic și eleganța se îmbină cu detaliile îndrăznețe, creând astfel o experiență unică. Un spațiu surprinzător, unde rafinamentul și fantezia se împletesc într-un omagiu adus creativității.

CZ —

Rádi vstupujeme do světa uměleckých překvapení, kde se klasická elegancie setkává s odvážnými a smělymi zvraty a vytváří jedinečný zážitek. Říše neočekávaného, kde se sofistikovanost setkává s rozmary a oslavuje kreativitu.

We love to step into a world of artful surprises, where classic elegance meets daring, audacious twists, creating a one-of-a-kind experience. A realm of the unexpected, where sophistication meets whimsy in a celebration of creativity.

1. C332 p.74 2. W214 p.98 3. W215 p.98 4. SX138 p.115



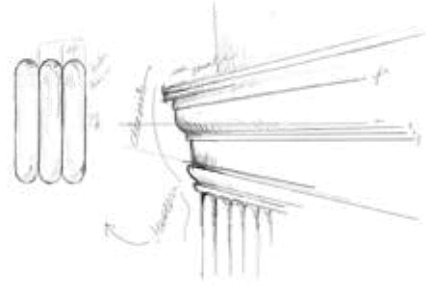

C332 NOBLESSE
W214 HILL BEAD XL

UA —
Пустотливе зіткнення
текстури та кольору;
яскраві візерунки та
глибокі відтінки створюють
несподівану гармонію.

PL —
Figlarna mieszanka tekstur
i kolorów; żywe wzory i
głębokie kolory tworzą
zaskakującą harmonię.

RO —
O îmbinare a texturilor și
culturilor, cu modele pline de
viață și nuanțe intense care
crează o armonie neașteptată.

CZ —
Rozpustilý střet textur a barev;
živé vzory a hluboké odstíny
vytvářejí nečekanou harmonii.

A mischievous collision
of texture and colour;
vibrant patterns and
deep hues crafting an
unexpected harmony.



1. C332 p.74 2. W215 p.98 3. SX138 p.115 4. W214 p.98 5. W110 p.98 6. PX209F p.133 7. WX210F p.97 8. WX211F p.97



2. **W215** p.98 3. **SX138** p.115 4. **W214** p.98



Walls oozing with
glamour and abundance,
beckoning you into
their captivating
design narrative.

UA —
Стіни, наповнені розкішшю і
достатком, приваблюють вас
своїм чарівним дизайном.

PL —
Ściany emanujące przepychem i
obfitością, zachęcają do zapoznania
się z ich urzekającą narracją.

RO —
Pereți care denotă extravaganta
și abundența, care vă cheamă în
universul designului lor captivant.

CZ —
Stěny oplývající půvabem a hojností,
které vás lákají do svého podmanivého
designového příběhu.



1. **PX175** p.131 2. **P8030** p.126

UA —
Неприборкана творчість розквітає в розкішному поєднанні кольору та хитромудрого дизайну.

PL —
Efekt kontrastu: gdzie ozdobne detale i spokojne odcienie znajdują śmiały wyraz.

RO —
Un tablou al contrastelor: unde detaliile ornamentale și nuanțele senine prind viață într-o exprimare îndrăzneață.

CZ —
Kontrastní obrazec, kde se odvážně projevují zdobné detaily a klidné odstíny.

A canvas of contrast:
where ornate details
and serene hues find
daring expression.



¹ PX175 p.131 ² P8030 p.126



³ P3020 p.127 ⁴ P3020A p.135 ⁵ P8050 p.126



¹ PX120 p.131 ² P4020 p.126

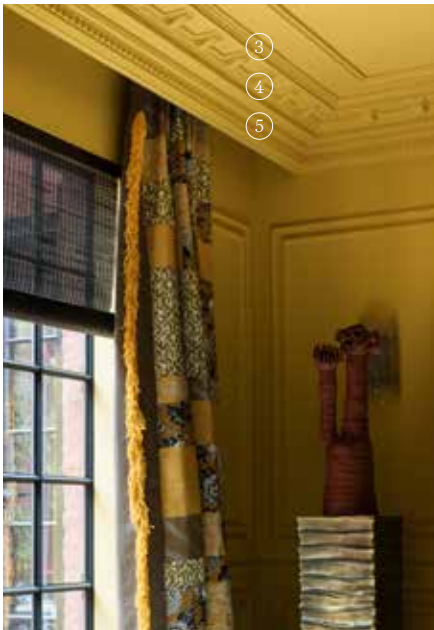

³ C305 p.70 ⁴ C307A p.70 ⁵ C211 p.70

Untamed creativity blooms in a lavish fusion of colour and intricate design.



Vibrant allure

1. PX120 p.131 2. P4020 p.126 3. C305 p.70 4. C307A p.70 5. C211 p.70 6. DX170-2300 p.158 7. D330LR p.158

UA —
Картина контрасту: пишні деталі та спокійні відтінки знаходять сміливе вираження.

PL —
Nieokiełznana kreatywność rozkwita w bogatej fuzji kolorów i misternego desingu.

RO —
Creativitatea nedomolită își găsește expresia potrivită într-un spațiu în care culorile și designul complex se contopesc.

CZ —
Nezkrotná kreativita rozkvétá v bohaté kombinaci barev a složitého designu.

Whenever you fancy a change,
our products are ready for
a repaint.



1- **PX120** p.131 2- **P4020** p.126 3- **C305** p.70 4- **C307A** p.70 5- **C211** p.70

UA —
Якщо ви забажаєте змін,
наші вироби завжди можна
перефарбувати.

PL —
Gdy tylko zapragniesz zmiany,
nasze produkty są gotowe do
przemalowania.

RO —
Ori de câte ori doriți o schimbare,
produsele noastre sunt gata pentru
a fi revopsite.

CZ —
Kdykoli budete mít chuť na
změnu, naše výrobky jsou
připraveny k přetření.



Essential still

We love to embrace the timeless charm of bygone eras as it speaks fluently in the language of today. A demonstration of how classic forms can be reinterpreted to remain ever-relevant.

UA —

Ми в захваті, коли шарм минулих епох може вільно розмовляти мовою сьогодення. Це демонстрація того, як класичні форми можуть бути переосмислені, щоб залишатися завжди актуальними.

PL —

Uwielbiamy momenty, w których niezaprzeczalny urok minionych epok płynnie łączy się ze współczesnym językiem. Jest to dowód na to, jak klasyczne formy mogą być reinterpretowane, zapewniając ich ciągłą aktualność.

RO —

Nu există nimic mai pasionant decât acele momente în care timpurile trecute prind glas în prezent. O demonstrație a modului în care formele clasice pot fi reinterpretate, pentru a nu-și pierde niciodată relevanța.

CZ —

Jsmě tak rádi, když nadčasový půvab minulých epoch mluví plynně jazykem dneška. Ukázka toho, jak lze klasické formy nově interpretovat, aby zůstaly stále aktuální.

1. C343 p.66 2. P8020 p.126 3. P4020 p.126 4. SX206 p.115



UA —

Вишукані елементи на стіні,
розташовані в довільній
послідовності, випромінюють
рівновагу та спокій.

PL —

Wyrafinowane elementy ułożone w
przemyślanej sekwencji na ścianie
emanują poczuciem równowagi i
spokojnej obecności.

RO —

Elemente rafinate care se succed pe pe-
rete, niciodată la întâmplare, sugerând
o prezentă echilibrată și calmă.

CZ —

Rafinované prvky v libovolném
pořadí na stěně vyzařují rovnováhu
a klidnou přítomnost.

C343 HERITAGE

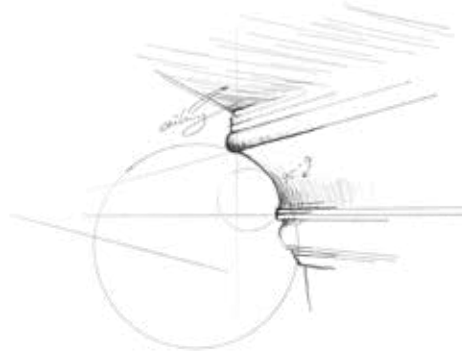

Refined elements,
in a far from arbitrary
sequence on the wall,
exude balance and
discrete presence.





1. **W109** p.100 2. **P9010** p.126 3. **P9050** p.128 4. **SX155** p.114

UA —
Стримана грація в кожній лінії,
що створює атмосферу спокійної
вишуканості.

PL —
Łagodność w każdej linii, tworząca
atmosferę cichego wyrafinowania.

RO —
Grație și echilibru în fiecare linie,
care creează o atmosferă plină de
rafinament și seninătate.

CZ —
Vyrovnáný pôvab v každé linii vytváří
atmosféru klidné sofistikovanosti.

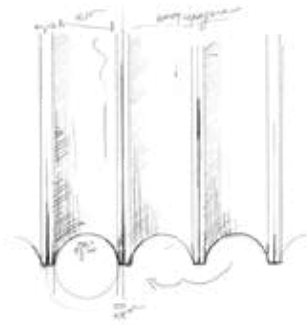

W109 VALLEY

Poised grace in every line,
creating an atmosphere of
calm sophistication.

1. W109 p.100 2. P9010 p.126 3. P9050 p.128





1. P8050 p.126



3. C305 p.70 4. C307A p.70 5. C211 p.70

UA —
Високі стелі, увінчані величними карнизами, розповідають нам про позачасову розкіш.

PL —
Wysokie sufity zwieńczone okazałymi gzymsami tworzą narrację ponadczasowego bogactwa.

RO —
Plafoane înalte, încheiate cu cornișe grandioase, expresie a unei opulențe atemporale.

CZ —
Vysoké stropy korunované honosnými profily vyprávějí o nadčasovém bohatství.

Towering ceilings
crowned with grand
cornices offer a narrative
of timeless opulence.

2. **PX175** p.131 3. **C305** p.70 4. **C307A** p.70 5. **C211** p.70 6. **P8030** p.126 7. **SX191** p.117





1- C343 p.66 2- P8020 p.126 3- P4020 p.126 4- SX191 p.117 5- DX170-2300 p.158 6- D330LR p.158

Grandeur in every detail, framed by a bold monochromatic use of saturated colours.



¹ C343 p.66 ² P8020 p.126 ³ P4020 p.126 ⁴ SX191 p.117

UA —

Велич у кожній деталі, обрамлена сміливим монохроматичним використанням насичених кольорів.

PL —

Wspaniałość w każdym detalu, otoczona odważnym monochromatycznym użyciem nasyconych barw.

RO —

Măreție pănă în cele mai mici detalii, evidențiată de culorile saturate, într-o execuție monocromatică.

CZ —

Velkolepost v každém detailu, rámovaná odvážným monochromatickým použitím sytých barev.

¹ P8030 p.126 ² CX160 p.91 ³ C332 p.74



UA —
Використовуйте для фарбування виробів текстурну фарбу, це додасть глибини та характеру будь-якому приміщенню.

PL —
Wzbogać nasze produkty farbą teksturowaną, aby uzyskać rzemieślnicze wykończenie, które doda głębi i charakteru każdemu pomieszczeniu.

RO —
Îmbunătățiți produsele noastre cu vopsea texturată pentru un finisaj artizanal care adaugă profunzime și caracter oricărei încăperi.

CZ —
Vylepšete naše produkty texturovanou barvou pro řemeslný povrch, který dodá hloubku a charakter každé místnosti.



3



Products

Discover our architectural elements, made for walls. Every product is an innovation with user ease in mind, designed to enhance and transform interiors. We propose a palette that matches styles and meets ideas. So that your walls can become the canvas for your imagination.

UA —

Відкрийте для себе наші стінові панелі. Кожен виріб — це, зручна у використанні інновація, створена для покращення та перевтілення інтер'єру. Ми пропонуємо палітру, яка поєднається з будь-яким стилем та допоможе втілити ваші ідеї. Ми перетворюємо стіни на простір для вашої фантазії.

PL —

Odkryj nasze elementy architektoniczne, stworzone do ścian. Każdy produkt jest innowacją, przygotowaną z myślą o wygodzie użytkownika oraz zaprojektowaną tak, aby ulepszać i przekształcać wnętrza. Proponujemy paletę, która pasuje do stylów i spełnia pomysły. Aby Twoje ściany mogły stać się płótnem dla Twojej wyobraźni.

RO —

Descoperă elementele noastre arhitecturale, create special pentru pereți. Fiecare produs este o inovație gândită pentru confortul utilizatorului, concepută să îmbunătățească și să transforme spațiile interioare. Îți oferim o paletă ce se potrivește diverselor stiluri și vine în întâmpinarea ideilor. Pentru ca pereții dvs. să devină pânza pentru imaginația dumneavoastră.

CZ —

Objevte naše architektonické prvky, vytvořené pro stěny. Každý produkt je inovace s myšlenkou na uživatelskou jednoduchost, navržený k vylepšení a transformaci interiérů. Nabízíme paletu, která odpovídá stylům a naplňuje nápady. Aby se vaše stěny mohly stát plátnem pro vaši představivost.

Materials

In-house engineered material compositions

ВІСОКОТЕХНОЛОГІЧНІ МАТЕРІАЛИ
MATERIAŁY TECHNICZNE
MATERIALE PROIECTATE INTELIGENT
KONSTRUKČNI MATERIÁLY

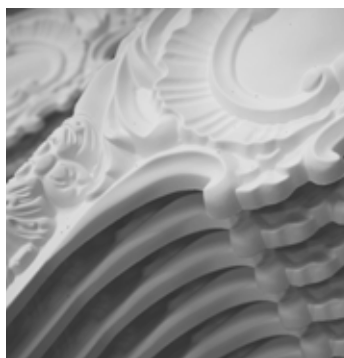

PUROTOUCH®

A high-quality, medium-density polyurethane that allows fine details.

Високоякісний матеріал середньої щільності, який дозволяє відтворити дрібні деталі — Wysokiej jakości, o dużej gęstości poliuretan pozwala uzyskać drobne szczegóły — Un poliuretan de înaltă calitate, cu densitate medie, care permite detalii fine — Vysoce kvalitní polyuretan vysoké hustoty umožňuje jemné detaily

Detail Design ☆☆☆

Impact Resistance ☆☆☆

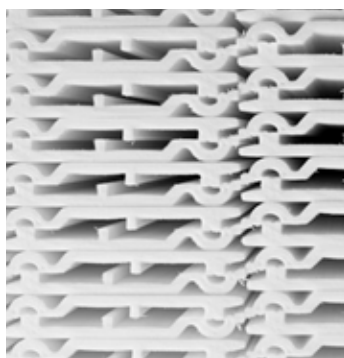

DUROPOLYMER®

An extruded and impact-resistant polymer based on a high-density polystyrene.

Екструдований ударостійкий полімер на основі полістиролу високої щільності — Tłoczony, odporny na uderzenia polimer powstały na bazie polistyrenu o wysokiej gęstości — Un polimer extrudat si rezistent la impact pe baza unui polistiren de inalta densitate. — Lisovaný, mechanicky odolný polymerna bázi hustého polystyrénu

Detail Design ☆☆☆

Impact Resistance ☆☆☆



DUROFOAM®

An extruded lightweight polymer based on a low-density polystyrene blend.

Екструдований легкий полімер на основі полістиролу низької щільності — Lekki, tłoczony polimer na bazie mieszanki polistyrenów o wysokiej gęstości — Un polimer extrudat, ușor, bazat pe un amestec de polistiren cu densitate mică — Lisovaný lehký polymer na bázi středně husté polystyrénové směsi

Detail Design ☆☆☆

Impact Resistance ☆☆☆



FLEX

A quality high-density flexible polyurethane.

Якісний еластичний поліуретан високої щільності — Formowany, wysokiej jakości elastyczny poliuretan o wysokiej gęstości — Un poliuretan flexibil de înaltă calitate și densitate mare — Kvalitní flexibilní polyuretan vysoké hustoty

Detail Design ☆☆☆

Impact Resistance ☆☆☆

READY TO PAINT

All of our products are ready to paint. Coloured end finishes on demand.

Усі наші вироби готові до фарбування —
 Wszystkie nasze produkty są gotowe do malowania. Kolory dostępne na życzenie —
 Toate produsele noastre sunt gata pentru vopsit. Culoare la cerere —
 Všechny naše výrobky jsou připraveny k okamžitému nátěru. Barvy na vyžádání



ПЕРЕВАГИ
 ZALETY
 AVANTAJE
 VÝHODY

Advantages



DURABLE

Orac products are designed to last a lifetime. Smart design and high-end technology assure strong and water resistant products.

Продукція Orac розроблена, щоб слугувати вам якомога довше. Продуманий дизайн і передові технології забезпечують міцність і водостійкість виробів — Produkty Orac zostały zaprojektowane z myślą o wieloletniej trwałości. Przemysłany projekt i najnowocześniejsza technologia zapewniają wytrzymałość i wodoodporność naszych produktów — Produsele Orac sunt concepute să reziste pe viață. Designul inteligent și tehnologia de vârf asigură produse durabile, rezistente la apă — Produkty Orac jsou navrženy tak, aby vydržely po celý život. Inteligentní design a špičková technologie přináší mechanicky odolné a voděodolné produkty

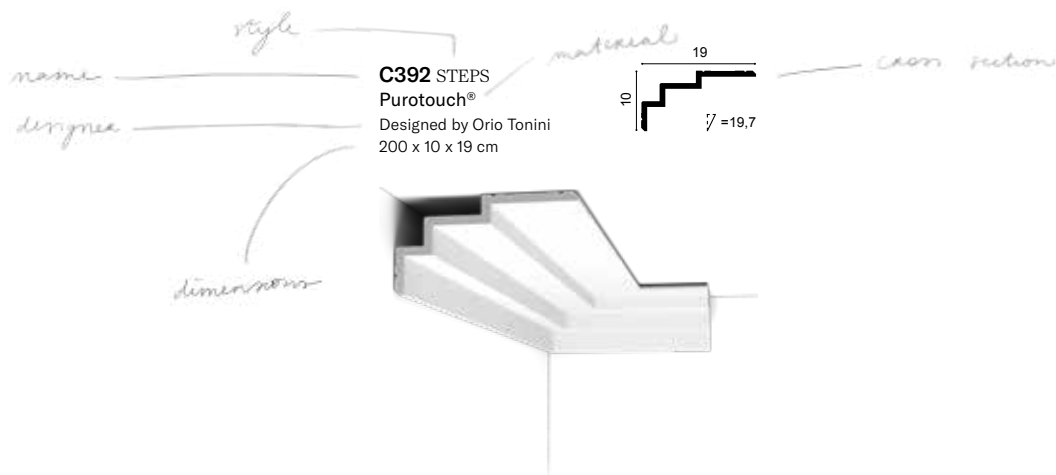

Legend

At Orac, our vision is to become restorative by 2050. This ambitious goal drives our material choices and operational practices, ensuring that every step we take not only minimizes environmental harm but actively contributes to ecological restoration. Since 2018 we have been making profound changes in the full lifecycle of our products. From selection and use of raw materials all the way to our production process.

— There are many sides to walls. We go for the good side.

UA —

V Orac mi прагнемо до 2050 року повністю відновити довкілля, яке зазнає негативного впливу від виробництва. Ця амбітна мета полягає у виборі матеріалів і методів виробництва: кожен наш крок не лише мінімізує шкоду для довкілля, а й активно сприяє його відродженню. З 2018 року ми докорінно змінюємо весь життєвий цикл нашої продукції - від вибору й використання сировини до виробничих процесів.
— Стіни мають багато сторін, і ми прагнемо обрати найкращу з них.

PL —

Naszą wizją w Orac jest odbudowa do roku 2050. Ten ambitny cel napędza nasze wybory materiałów i praktyki operacyjne, dążąc do minimalizowania szkód w środowisku poprzez aktywne przyczynianie się do odnowy ekologicznej. Od 2018 roku wprowadzamy głębokie zmiany w całym cyklu życia naszych produktów. Od wyboru i wykorzystania surowców, aż po proces produkcji.
— Ściany mają wiele stron. My stawiamy na tę dobrą.

RO —

La Orac, viziunea noastră este de a deveni restauratori până în 2050. Acest obiectiv ambițios ne determină să folosim alegețile materiale și practicile operaționale, asigurând că fiecare pas pe care îl facem nu numai că minimizează daunele aduse mediului, ci contribuie în mod activ la refacerea ecologică. Începând cu anul 2018 am făcut schimbări profunde în întregul ciclu de viață al produselor noastre. De la selecția și utilizarea materiilor prime până la procesul nostru de producție. — Pereții au mai multe laturi. Noi mergem pe latura bună.

CZ —

Naší vizí ve společnosti Orac je stát se obnovujícími do roku 2050. Tento ambiciózní cíl je hnacím faktorem při volbě našich materiálů a a provozních postupů, čímž zajišťujeme, že každý náš krok nejen minimalizuje poškozování životního prostředí, ale aktivně přispívá k ekologické obnově. Od roku 2018 provádíme zásadní změny v celém životním cyklu našich výrobků. Od výběru a použití surovin až po náš výrobní proces.
— Stěny mají mnoho stran. My jdeme za tou dobrou stranou.



0% VIRGIN FOSSIL-BASED MATERIALS

Orac's design merge recycled, bio-based and plant based materials, emphasizing sustainable innovation.



SUSTAINABLE OPERATIONS

Orac has been CO₂ neutral for the full scope 1 and 2 since 2021, working towards climate positivity by 2050.



**BUILT TO LAST,
BUILT RESPONSIBLY**

Our durable products with a lasting lifetime support a sustainable, circular economy.



MORE THAN WALLS

Orac's commitment to sustainability extends to community engagement and social responsibility.

Product overview



01

p. 64



02

p. 94



05

p. 136



06

p. 152

- 01 Cornice mouldings
- 02 3D Wall covering
- 03 Skirting boards
- 04 Panel mouldings
- 05 Indirect lighting
- 06 Deco elements
- 07 The perfect finish
- 08 Flexible products



03

p. 110



04

p. 124



07

p. 162



08

p. 166

Cornice mouldings

01



КАРНИЗИ
GZYMSY
CORNISE
STROPNÍ LIŠTY

It truly does move us when we look up and see how it softens the strict transition between wall and ceiling. For us, a cornice is about attention to detail, be it from ornate to subtle. We have thought them all through so that there should always be an option that meets your personal aspirations.

UA –

Це зворушує нас. Коли ми дивимось вгору і бачимо, як він пом'якшує строгий перехід між стіною та стелею. Для нас карниз — це увага до деталей. Від витюватих до витончених. Ми продумали їх до дрібниць, щоб завжди був варіант, який відповідає вашим особистим вподобанням.

PL –

Naprawdę porusza nas, gdy patrzymy w górę i dostrzegamy, jak listwa sufitowa łądzi gwałtowne przejście między ścianą a sufitem. Dla nas gzyms to dbałość o szczegóły, od ozdobnych po subtelne. Skrupulatnie przeanalizowaliśmy każdy projekt, aby zawsze istniała opcja zgodna z osobistymi preferencjami.

RO –

Ne impresionează. Atunci când ne ridicăm privirea și vedem cum tranziția bruscă de la perete la plafon este echilibrată, atenuată. Pentru noi, cornișele sunt expresia atenției la detalii. De la bogat ornamentat la subtil. Le-am conceput cu o atenție deosebită. Pentru ca dvs. să aveți întotdeauna la îndemână o opțiune care să ilustreze propriile dvs. aspirații.

CZ –

Opravdu nás to dojíhá. Když se podíváme nahoru a vidíme, jak zmírňuje přísný přechod mezi stěnou a stropem. Stropní lišta je pro nás o zaměření na detail. Od zdobných až po decentní. Všechny jsme je promýšleli. Tak, aby vždy existovala možnost, která splňuje vaše osobní představy.

C341 | C341F HERITAGE
Purotouch®
200 x 8,8 x 12,2 cm

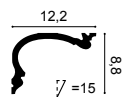

C342 HERITAGE
Purotouch®
200 x 14 x 19 cm

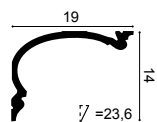

① **C343 HERITAGE**
Purotouch®
200 x 19 x 25 cm

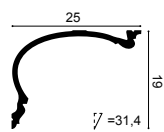

C344 HERITAGE
Purotouch®
200 x 27,3 x 35 cm

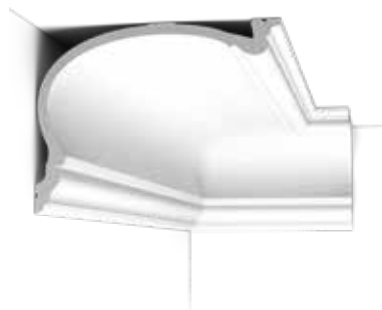
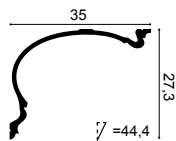

1. C343 2. P8020 p.126





Cornice mouldings

1. C327 2. P8030 p.126 3. P8020 p.126 4. SX191 p.117

C325 MANOIR
Purotouch®
200 x 7 x 6,5 cm

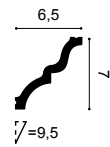

C326 MANOIR
Purotouch®
200 x 10,5 x 9 cm

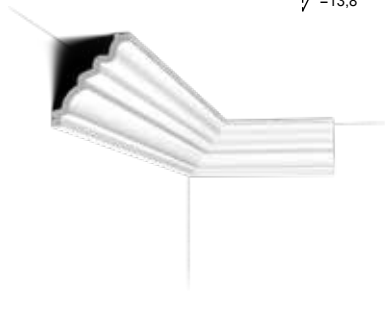
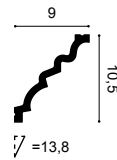

C327 MANOIR
Purotouch®
200 x 14,3 x 15,9 cm

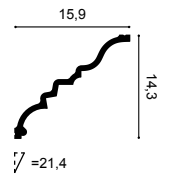

C338 BA'ROCK
Purotouch®
200 x 18,2 x 18,2 cm

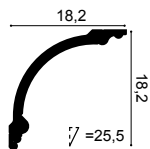

C338A BA'ROCK
Purotouch®
200 x 18,2 x 18,2 cm
Dessin: 120 cm

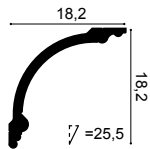

C338B BA'ROCK
Purotouch®
200 x 18,2 x 18,2 cm
Dessin: 2 x 57 cm

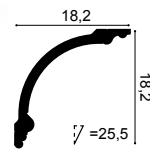

C336 BA'ROCK
Purotouch®
200 x 27,1 x 26,6 cm

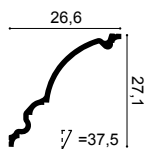

1. C217



C230 | C230F
Purotouch®
200 x 2,9 x 2,9 cm

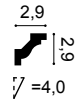

C215 | C215F
Purotouch®
200 x 4,7 x 4,7 cm

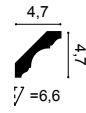

C322
Purotouch®
200 x 5 x 4,2 cm

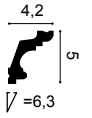

C328 NEW
Purotouch®
200 x 9 x 6,8 cm

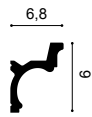

C200
Purotouch®
200 x 6,5 x 5,7 cm



C220 | C220F
Purotouch®
200 x 7,6 x 11,6 cm

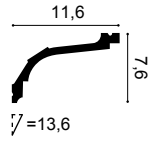

C213 | C213F
Purotouch®
200 x 8 x 8 cm



① **C217 | C217F**
Purotouch®
200 x 15,6 x 10,3 cm

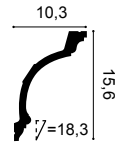

C217 | C217F ↷ 90°
Purotouch®
200 x 10,3 x 15,6 cm

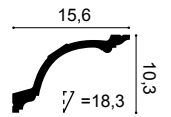

C216
Purotouch®
200 x 11,6 x 13,3 cm

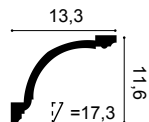

C301
Purotouch®
200 x 17 x 14,4 cm

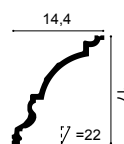

C305
Purotouch®
200 x 4,7 x 15,5 cm

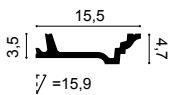

C305 + C213

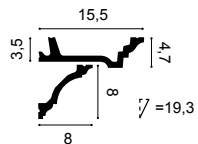

C305 + C211

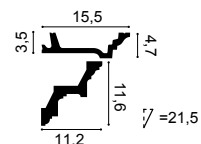

C211 | C211F
Purotouch®
200 x 11,6 x 11,2 cm

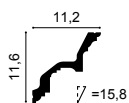

C422
Purotouch®
200 x 16,4 x 19,4 cm

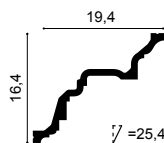

C307
Purotouch®
200 x 19,5 x 19,5 cm

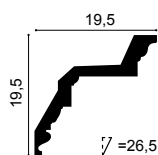

(A) C307 + C307A (B)
Purotouch®
Duropolymer®
C307A: 7,5 x 4 x 9,4 cm

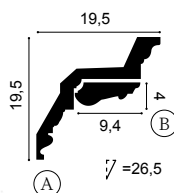



1. PX175 p.131 2. C305 3. C307A 4. C211 5. P8030 p.126 6. SX191 p.117

1 C219



C333 | C333F
Purotouch®
200 x 12,2 x 11,1 cm

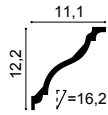

C331 | C331F
Purotouch®
200 x 6,1 x 13,5 cm

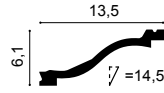

C334 | C334F
Purotouch®
200 x 15 x 19,6 cm

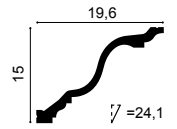

C902 | C902F
Purotouch®
200 x 10,3 x 10,3 cm

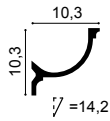

C901 | C901F
Purotouch®
200 x 14,8 x 12,4 cm

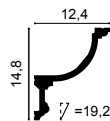

C900
Purotouch®
200 x 17,1 x 14,6 cm

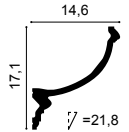

C212
Purotouch®
200 x 7,5 x 4,5 cm



C201
Purotouch®
200 x 11,6 x 4,8 cm

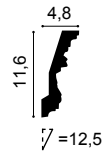

C304 | C304F
Purotouch®
200 x 12,2 x 7,2 cm



C303
Purotouch®
200 x 14,4 x 6,5 cm



① **C219**
Purotouch®
200 x 17,6 x 13 cm

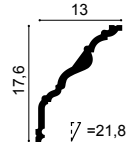

C321 | C321F
Purotouch®
200 x 9,9 x 5 cm

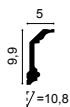

C339 | C339F
Purotouch®
200 x 14,1 x 6,4 cm

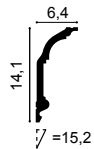

C332 NOBLESSE
Purotouch®
200 x 23 x 11,4 cm

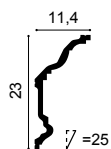

C332 NOBLESSE 90°
Purotouch®
200 x 11,4 x 23 cm

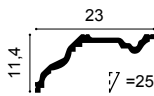

C340
Purotouch®
200 x 25,6 x 13,5 cm

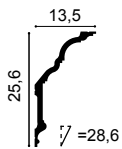

C340 90°
Purotouch®
200 x 13,5 x 25,6 cm

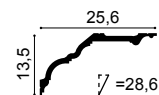

the perfect finish



1- C332 2- P8020 p.126 3- SX118 p.113



C250 | C250F
Purotouch®
200 x 1,6 x 1,6 cm

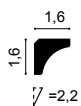

C260
Purotouch®
200 x 4,1 x 4,8 cm

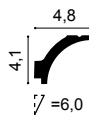

C240 | C240F
Purotouch®
200 x 8 x 8 cm

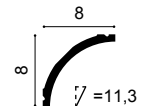

¹-C990 + 2x CX188 p.146



C991
Purotouch®
200 x 14 x 11 cm
Designed by Ulf Moritz

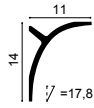

C991 + P9900

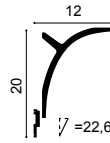

C991 + 2x P9900

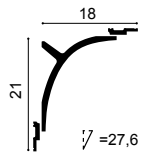

① **C991** 90°
Purotouch®
200 x 11 x 14 cm
Designed by Ulf Moritz

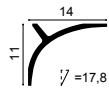

C991 + P9900 90°

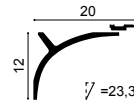

C991 + 2x P9900 90°

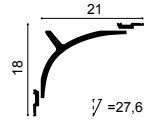

C990 INFINITY
Purotouch®
200 x 21,6 x 15,9 cm
Designed by Xavier Donck

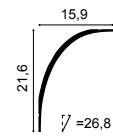

C990 + P9900

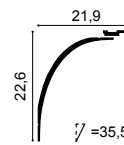

C990 + 2x P9900

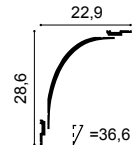

① **C990 INFINITY** 90°
Purotouch®
200 x 15,9 x 21,6 cm
Designed by Xavier Donck

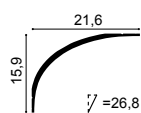

C990 + P9900 90°

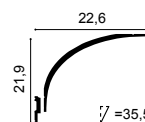

C990 + 2x P9900 90°

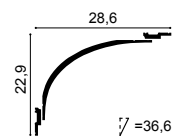



CORNICE MOULDINGS | KROONLIJSTEN | CORNICHES | STUCKLEISTEN | CORNISAS

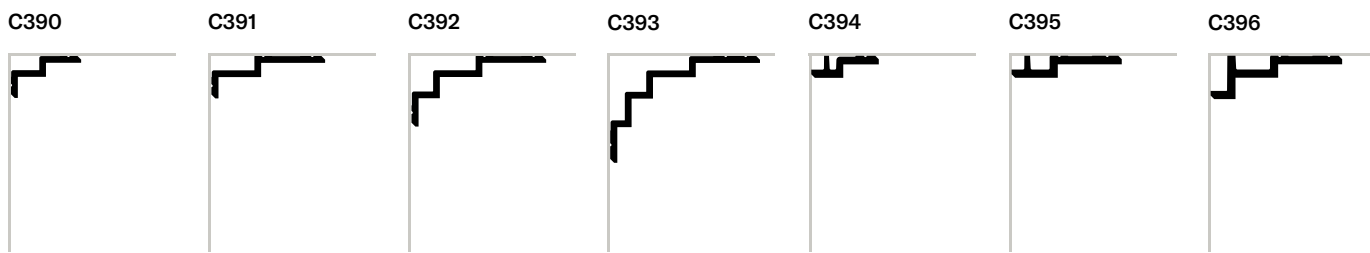

BORDER

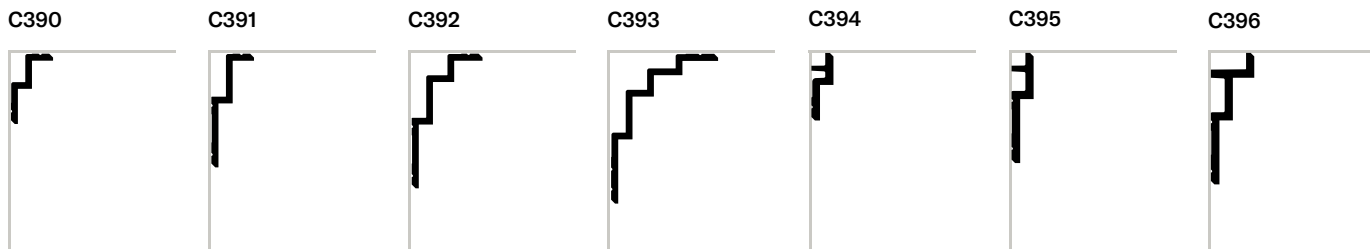

CURTAIN PROFILES | GORDIJNPROFIELEN | PROFILS RIDEAU | GARDINENLEISTEN | CORNISAS PARA CORTINAS

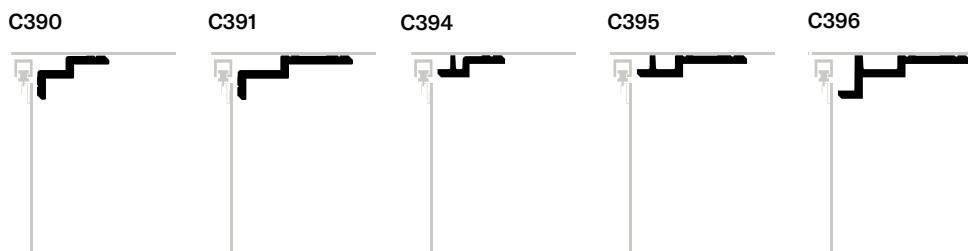

LED COVING | INDIRECTE VERLICHTING | ÉCLAIRAGE INDIRECT | INDIRECTE BELEUCHTUNG | ILUMINACIÓN INDIRECTA



Downlighter

Uplighter

C394 STEPS
Purotouch®
200 x 9,5 x 3,1 cm
Designed by Orio Tonini



C395 STEPS
Purotouch®
200 x 15,5 x 3,1 cm
Designed by Orio Tonini



C396 STEPS
Purotouch®
200 x 18,5 x 6,1 cm
Designed by Orio Tonini

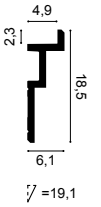

C390 STEPS
Purotouch®
200 x 6 x 10 cm
Designed by Orio Tonini



① **C391 STEPS**
Purotouch®
200 x 6 x 16 cm
Designed by Orio Tonini

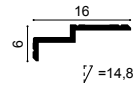

C392 STEPS
Purotouch®
200 x 10 x 19 cm
Designed by Orio Tonini

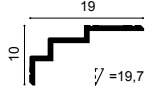

② **C393 STEPS**
Purotouch®
200 x 15 x 21 cm
Designed by Orio Tonini

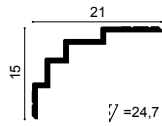

① C391 ② C393



C360
Purotouch®
200 x 2,1 x 6 cm
Designed by Jacques Vergracht



C356
Purotouch®
200 x 2 x 10 cm
Designed by Jacques Vergracht

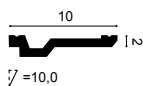

① **C355**
Purotouch®
200 x 3,5 x 11,1 cm
Designed by Jacques Vergracht



C353
Purotouch®
200 x 3 x 16,5 cm
Designed by Jacques Vergracht

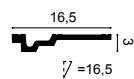

C354
Purotouch®
200 x 4 x 21,5 cm
Designed by Jacques Vergracht

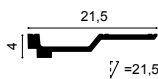

C602
Purotouch®
200 x 5,3 x 5 cm
Designed by Jacques Vergracht



C400
Purotouch®
200 x 6 x 10 cm
Designed by Jacques Vergracht





1- C355 2- C991 p.77

Curtain profiles

КАРНИЗИ ДЛЯ ШТОР
PROFILE KARNISZOWE
CORNİŞE PENTRU PERDELE
GARNÝŽOVÉ PROFILY

ORAC



1. C340

**C394 STEPS
CURTAIN PROFILE**
Purotouch®
200 x 3,1 x 9,5 cm
Designed by Orio Tonini

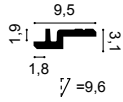

**C395 STEPS
CURTAIN PROFILE**
Purotouch®
200 x 3,1 x 15,5 cm
Designed by Orio Tonini

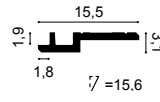

**C390 STEPS
CURTAIN PROFILE**
Purotouch®
200 x 6 x 10 cm
Designed by Orio Tonini

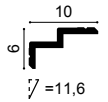

**C391 STEPS
CURTAIN PROFILE**
Purotouch®
200 x 6 x 16 cm
Designed by Orio Tonini

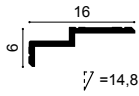

**C396 STEPS
CURTAIN PROFILE**
Purotouch®
200 x 6,1 x 18,5 cm
Designed by Orio Tonini

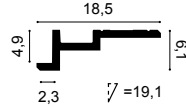

**C991
CURTAIN PROFILE**
Purotouch®
200 x 11 x 14 cm
Designed by Ulf Moritz

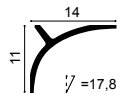

**C341 | C341F HERITAGE
CURTAIN PROFILE**
Purotouch®
200 x 8,8 x 12,2 cm

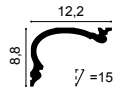

**C342 HERITAGE
CURTAIN PROFILE**
Purotouch®
200 x 14 x 19 cm

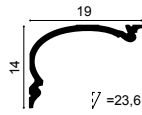

**C343 HERITAGE
CURTAIN PROFILE**
Purotouch®
200 x 19 x 25 cm

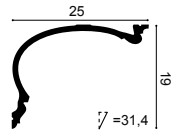

① **C340
CURTAIN PROFILE**
Purotouch®
200 x 13,5 x 25,6 cm

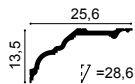

**CX196 U-STEPS
CURTAIN PROFILE**

Duopolymer®
200 x 4 x 11,3 cm

Designed by Orio Tonini



**CX197 U-STEPS
CURTAIN PROFILE**

Duopolymer®
200 x 5 x 9,3 cm

Designed by Orio Tonini



**CX215-2600 LEDGE (NEW)
CURTAIN PROFILE**

Duopolymer®
260 x 9,5 x 4,5 cm



**CX216-2600 LEDGE (NEW)
CURTAIN PROFILE**

Duopolymer®
260 x 12,5 x 4,5 cm



**CX217-2600 LEDGE (NEW)
CURTAIN PROFILE**

Duopolymer®
260 x 15,5 x 5 cm





1. CX215

CX124 | CX124F
Duopolymer®
200 x 4,9 x 4,9 cm

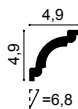

CX100 | CX100F
Duopolymer®
200 x 6,9 x 7,1 cm

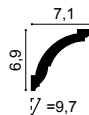

CX123 | CX123F
Duopolymer®
200 x 8 x 8 cm

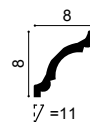

CX127 | CX127F
Duopolymer®
200 x 9,4 x 9,4 cm

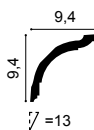

CX199 | CX199F
Duopolymer®
200 x 8 x 8 cm

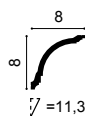

CX106 | CX106F
Duopolymer®
200 x 11,8 x 11,7 cm

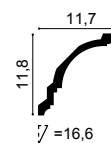

¹ P8030 p.126 ² P8020 p.126 ³ CX110



③ **CX111**
Duropolymer®
200 x 2,6 x 1,5 cm

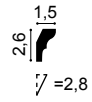

CX110 | CX110F
Duropolymer®
200 x 4,5 x 4,1 cm

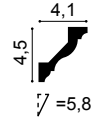

CX108
Duropolymer®
200 x 5,4 x 5,5 cm

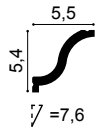

CX112
Duropolymer®
200 x 5,4 x 3,8 cm



CX177
Duropolymer®
200 x 7 x 6 cm

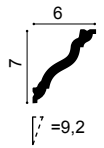

CX129
Duropolymer®
200 x 9,4 x 9,4 cm

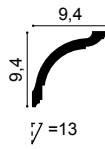

CX107
Duropolymer®
200 x 11,8 x 11,7 cm

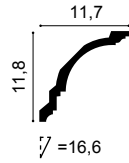

the perfect finish



CX133
Duopolymer®
200 x 2 x 2 cm



CX132
Duopolymer®
200 x 2 x 2 cm



CX115
Duopolymer®
200 x 3 x 2,9 cm



CX109 | CX109F
Duopolymer®
200 x 4,4 x 4,4 cm

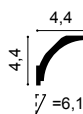

CX126
Duopolymer®
200 x 8,7 x 8,7 cm

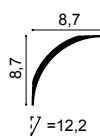

CX148
Duopolymer®
200 x 4,3 x 2,9 cm

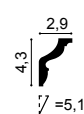

CX141
Duopolymer®
200 x 5,9 x 3,1 cm



CX176
Duopolymer®
200 x 8 x 4 cm

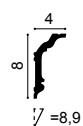

CX192
Duopolymer®
200 x 12 x 6 cm

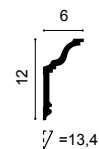

CX215-2600 LEDGE (NEW)
Duopolymer®
260 x 9,5 x 4,5 cm



CX216-2600 LEDGE (NEW)
Duopolymer®
260 x 12,5 x 4,5 cm



CX217-2600 LEDGE (NEW)
Duopolymer®
260 x 15,5 x 5 cm

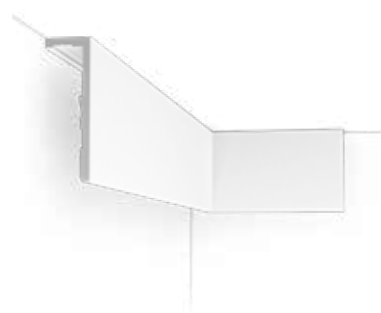

Products

① **CX190 | CX190F** U-PROFILE
 Duopolymer®
 200 x 2 x 3 cm
 Designed by Orio Tonini



CX196 U-STEPS
 Duopolymer®
 200 x 11,3 x 4 cm
 Designed by Orio Tonini

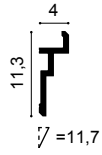

CX197 U-STEPS
 Duopolymer®
 200 x 9,3 x 5 cm
 Designed by Orio Tonini

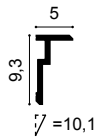

② **PX198 | PX198F** U-STEPS
 Duopolymer®
 200 x 8,3 x 2 cm
 Designed by Orio Tonini



PX198 | PX198F U-STEPS 90°
 Duopolymer®
 200 x 2 x 8,3 cm
 Designed by Orio Tonini



Cornice mouldings

1. CX190F 2. PX198F 3. W111F p.103 4. W116F p.103 5. W119F p.103

1. CX192 p.88 2. P8030 p.126



SX194 | SX194F SQUARE
 Duropolymer®
 200 x 1 x 2 cm



SX162 | SX162F SQUARE
 Duropolymer®
 200 x 1 x 4 cm



SX157 | SX157F SQUARE
 Duropolymer®
 200 x 1,3 x 6,5 cm



SX163 | SX163F SQUARE
 Duropolymer®
 200 x 1,3 x 10,1 cm

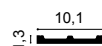

SX182 | SX182F CASCADE
 Duropolymer®
 200 x 1,3 x 5 cm



SX183 | SX183F CASCADE
 Duropolymer®
 200 x 1,3 x 7,5 cm

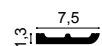

SX184 | SX184F CASCADE
 Duropolymer®
 200 x 1,3 x 11 cm

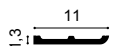

CX160
 Duropolymer®
 200 x 1,3 x 3,9 cm



CX161
 Duropolymer®
 200 x 1,3 x 6,9 cm

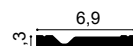

the perfect finish



CB500N
Durofoam®
200 x 2,5 x 1,8 cm

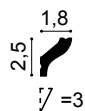

CB501N
Durofoam®
200 x 4,1 x 3,5 cm

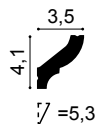

CB502N
Durofoam®
200 x 5,9 x 4,9 cm



CB520N
Durofoam®
200 x 3,5 x 3,5 cm

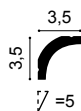

CB521N
Durofoam®
200 x 5 x 5 cm

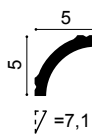

CB522N
Durofoam®
200 x 6,7 x 6,7 cm

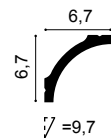

CB525N
Durofoam®
200 x 6,5 x 6 cm

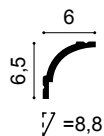

CB523N
Durofoam®
200 x 5,9 x 4,4 cm

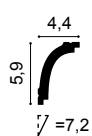

CB510N
Durofoam®
200 x 4 x 4 cm

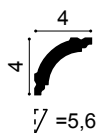

CB511N
Durofoam®
200 x 6,7 x 6,7 cm

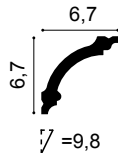

① **CB512N**
Durofoam®
200 x 9 x 9 cm

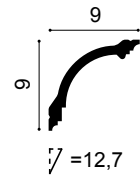

CB503N
Durofoam®
200 x 8,2 x 9,2 cm

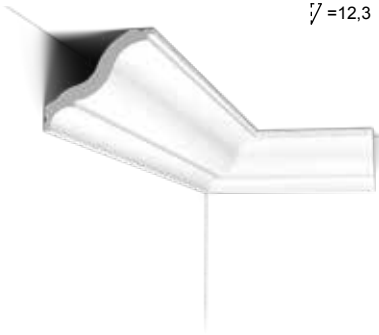
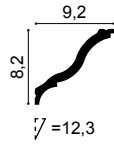

CB524N
Durofoam®
200 x 9 x 9 cm

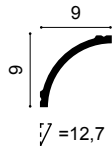

¹ CB512N ² PX103 p.131

3D Wall covering

02

СТИНОВІ 3D-ПАНЕЛІ
PANELE 3D
PANOURI DECORATIVE 3D
3D NÁSTĚNNÉ OBLOŽENÍ

We invite you to experience the extraordinary with our 3D wall coverings. Captivating sculptural landscapes, these masterpieces redefine your walls, inviting touch and exploration. Discover a range of bold and subtle designs, each a testament to the art of interior transformation.

UA —

Пориньте у дивовижний світ наших 3D-покриттів для стін. Рельєфна поверхня створює унікальний і привабливий графічний ефект на стіні, до якого так і хочеться доторкнутися. Відкрийте для себе низку сміливих і витончених дизайнів, кожен з яких є підтвердженням трансформації мистецтва інтер'єру.

PL —

Jeśli chcesz, możesz doświadczyć niezwykłości dzięki naszym panelom ściennym 3D. Urzekające rzeźbiarskie krajobrazy. Te arcydzieła na nowo definiują Twoje ściany, zachęcając do dotyku i eksploracji. Poznaj gamę odważnych i subtelnych wzorów, z których każdy jest świadectwem sztuki transformacji wnętrz.

RO —

Te invităm să descoperi extraordinarul prin colecția noastră de panouri decorative 3D. Peisaje sculpturale captivante. Aceste capodopere vă vor redefini pereteii, invitându-vă să-i atingeți, să-i explorați. Explorează o varietate de modele îndrăznețe și subtile, fiecare reflectând arta transformării interioarelor.

CZ —

Pokud chcete, zažijte s našimi 3D nástěnnými obklady něco výjimečného. Podmanivé plastické scény. Tato mistrovská díla nově definují vaše stěny a vybízejí k dotekům a zkoumání. Prozkoumejte řadu odvážných i jemných vzorů, z nichž každý je dokladem umění proměny interiéru.

— Where art meets science

Duropolimer isn't new to us, but our method is. We have been making profound changes in the full lifecycle of this product. We are combining bio-based raw materials with recycled elements to create 100% sustainable masterpieces. And we've got the ISCC certification* to prove it (for the biobased share).



**BIO-BASED RAW
MATERIALS WITH
ISCC CERTIFICATION**



**RECYCLED
POST-CONSUMER AND
POST-INDUSTRIAL WASTE**

UA —

Дуорополімер не є новим продуктом, але новим є спосіб його виробництва. Ми докорінно змінили весь життєвий цикл цього продукту. Поєднавши біологічну сировину з переробленими елементами, ми створили цей 100% сталій шедевр. Це підтверджує наш сертифікат ISCC* (для біосировини).

PL —

Duropolimer nie jest dla nas nowością, ale naszą metodą owszem. Dokonałiśmy głębokich zmian w całym cyklu życia tych produktów. Łączymy surowce pochodzenia naturalnego z elementami z recyklingu, aby stworzyć w 100% zrównoważone arcydzieła. Posiadamy certyfikat ISCC* jako dowód (na biopochodne produkty).

RO —

Duropolimerul nu este ceva nou pentru noi, dar metoda noastră este nouă. Am realizat în ultimii ani profunde schimbări în întregul ciclu de viață al acestui produs. Combinăm materii prime de origine biologică cu elemente reciclate pentru a crea capodopere 100% sustenabile. Și avem și certificarea ISCC* pentru a dovedi acest lucru (pentru partea de biobază).

CZ —

Duropolymery pro nás není novinkou, ale naše metoda je nová. Děláme zásadní změny v celém životním cyklu tohoto produktu. Kombinujeme biomateriály s recyklovanými materiály, abychom vytvořili tato 100% udržitelná mistrovská díla. A získali jsme certifikaci ISCC* jako potvrzení pro podíl biosložky.

WX204 | WX204-2600 RIPPLE

Duopolymer®
200 x 25 x 1,6 cm
260 x 25 x 1,6 cm

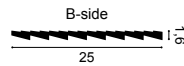
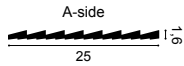

WX205 | WX205-2600 | WX205F TRACK

Duopolymer®
200 x 25 x 1,3 cm
260 x 25 x 1,3 cm

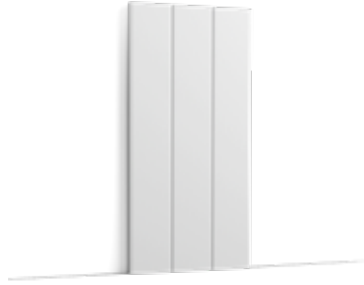
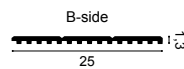
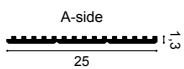

① **WX210 | WX210-2600 | WX210F REED**

Duopolymer®
200 x 25,5 x 1,2 cm
260 x 25,5 x 1,2 cm



② **WX211 | WX211-2600 | WX211F FLUTE**

Duopolymer®
200 x 25,5 x 1,7 cm
260 x 25,5 x 1,7 cm



WX218 | WX218-2600 | WX218F FLUTE.XL NEW

Duopolymer®
200 x 25,5 x 1,7 cm
260 x 25,5 x 1,7 cm

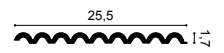

WX213 | WX213-2600 | WX213F ALTO NEW

Duopolymer®
200 x 25 x 1,2 cm
260 x 25 x 1,2 cm

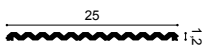

SX207 | SX207F SQUARE

Duopolymer®
200 x 25 x 1,3 cm

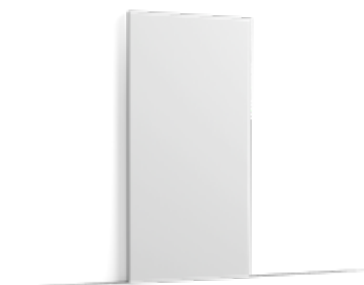

1. WX210 2. WX211

W108 | W108-2600 | W108F ZIGZAG

Purotouch®
200 x 25 x 1,8 cm
260 x 25 x 1,8 cm

Designed by Orio Tonini

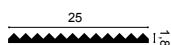

W108 ZIGZAG + 2x CX190



⑤ **W110 | W110-2600 | W110F HILL**

Purotouch®
200 x 25 x 1,6 cm
260 x 25 x 1,6 cm

Designed by Orio Tonini

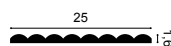

W110 HILL + 2x CX190



② **W213 HILL TRACE**

Purotouch®
200 x 25 x 1,6 cm

Designed by Orio Tonini

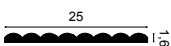

W214 | W214F HILL BEAD XL

Purotouch®
200 x 40 x 1,5 cm

Designed by Orio Tonini



W215 HILL BEAD

Purotouch®
50 x 80 x 1,5 cm

Designed by Orio Tonini





3D Wall covering

1. PX209 p.133 2. W213 3. WX210 p.97 4. WX211 p.97 5. W110 6. CX190 p.118



1. W109 2. PX209 p.133 3. W212

① W109 | W109-2600 | W109F VALLEY

Purotouch®
200 x 25 x 1,2 cm
260 x 25 x 1,2 cm
Designed by Orio Tonini

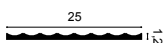

W114 | W114-2600 | W114F VALLEY XL

Purotouch®
200 x 25 x 1,5 cm
260 x 25 x 1,5 cm
Designed by Orio Tonini

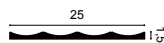

③ W212 VALLEY LOOP

Purotouch®
200 x 25 x 1,2 cm
Designed by Orio Tonini

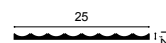

W109 VALLEY + 2x CX190



W114 VALLEY XL + 2x SX194



③ W212 VALLEY LOOP + 2x PX209



⑥ **W217** PILLOW
Purotouch®
200 x 25 x 2,3 cm
Designed by Orio Tonini

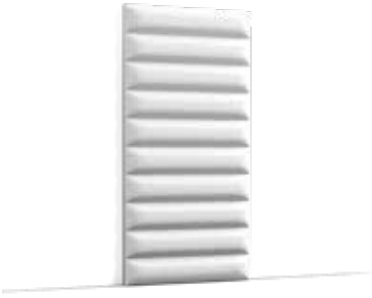

④ ⑥ **W217** PILLOW + **SX182**



⑤ **W218** QUILT
Purotouch®
200 x 25 x 2,3 cm
Designed by Orio Tonini



⑤ ⑥ **W218** QUILT + **SX182**



2. **PX209** p.133 4. **W217** 5. **W218** 6. **SX182** p.113



— Beyond surface beauty

ACOUSTIC CONTRIBUTION — CLASS E

In combination with other elements, Purotouch has a positive effect on the overall sound quality, absorbing up to 25% of conversational sounds.

THERMAL COMFORT

Purotouch offers thermal insulation comparable to that of specialized insulation boards of equal thickness.

$\lambda = 0,029 \text{ W/mK}$

ECO-CONSCIOUS FROM MATERIAL TO FINISH

Over 11% of Purotouch's composition is biobased, sourced from sugar beet and sugar cane. Additionally, we apply a primer paint that contains 14% biobased content.

UA —

ЗВУКОІЗОЛЯЦІЯ — КЛАС Е
У поєднанні з іншими елементами, Purotouch позитивно впливає на загальну акустику приміщення, поглинаючи до 25% шуму всередині приміщення.

ТЕПЛОВИЙ КОМФОРТ
Purotouch забезпечує теплоізоляцію, яку можна порівняти з теплоізоляцією спеціалізованих ізоляційних плит такої ж товщини.
 $\lambda = 0,029 \text{ Вт/мК}$

ЕКОЛОГІЧНІСТЬ ВІД МАТЕРІАЛУ ДО ФІНІШНОГО ПОКРИТТЯ.
Більше 11% складу Purotouch — це біоматеріали, отримані з цукрових буряків та тростини. Крім того, ми використовуємо праймер, який містить 14% інгредієнтів біологічного походження.

RO —

CONTRIBUȚIE ACUSTICĂ - CLASA E
În combinație cu alte elemente, Purotouch are un efect pozitiv asupra calității generale a sunetului, absorbind până la 25% din sunetele conversaționale.

CONFORT TERMIC
Purotouch oferă o izolare termică comparabilă cu cea a plăcilor izolante specializate de grosime egală.
 $\lambda = 0,029 \text{ W/mK}$

CONȚINUT DE ASPECTELE ECOLOGICE, DE LA MATERIAL PÂNĂ LA FINISAJ
Peste 11% din compoziția Purotouch este de origine biologică, provenită din sfeclă de zahăr și trestie de zahăr. În plus, aplicăm un grund cu un conținut de 14% de origine biologică.

PL —

WKŁAD AKUSTYCZNY — KLASA E
W połączeniu z innymi elementami, Poliuretan posiada m.in. pozytywny wpływ na ogólną jakość dźwięku, pochłaniając do 25% dźwięków konwersacyjnych.

KOMFORT TERMICZNY
Purotouch oferuje izolację termiczną porównywalną ze specjalistycznymi płytami izolacyjnymi o tej samej grubości.
 $\lambda = 0,029 \text{ W/mK}$

ŚWIADOMOŚĆ EKOLOGICZNA OD MATERIAŁU DO WYKONCZENIA
Ponad 11% składu Purotouch jest pochodzenia biologicznego, pozyskiwane z buraków cukrowych i trzciny cukrowej. Dodatkowo stosujemy farbę podkładową, która zawiera 14% składników pochodzenia biologicznego.

CZ —

AKUSTICKÝ PŘÍNOS - TŘÍDA E
V kombinaci s dalšími prvky má Purotouch pozitivní vliv na celkovou kvalitu zvuku, protože pohlcuje až do 25 % konverzačních zvuků.

TEPELNÝ KOMFORT
Purotouch nabízí tepelnou izolaci srovnatelnou s tepelnou izolací specializovaných izolačních desek stejné tloušťky. $\lambda = 0,029 \text{ W/mK}$

EKOLOGICKY ŠETRNÝ OD MATERIÁLU AŽ PO POUŽITÍ
Více než 11 % složení materiálu Purotouch tvoří biosložky pocházející z cukrové řepy a cukrové třtiny. Kromě toho používáme základní barvu, která obsahuje 14 % biobavlny.



1. W116 2. W111 3. W119 4. CX190 p.118

3D Wall covering

② W111 | W111-2600 | W111F BAR

Purotouch®
200 x 25 x 2 cm
260 x 25 x 2 cm
Designed by Orio Tonini

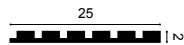

① W116 | W116F BAR XL

Purotouch®
200 x 25 x 2 cm
Designed by Orio Tonini

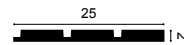

③ W119 | W119F BAR MIX

Purotouch®
200 x 25 x 2 cm
Designed by Orio Tonini

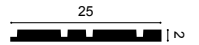

② ④ W111 BAR + CX190 + PX198



① ④ W116 BAR XL + CX190 + PX198



③ ④ W119 BAR MIX + CX190 + PX198



② **W115 SLOPE**

Purotouch®
200 x 25 x 2,3 cm
Designed by Orio Tonini

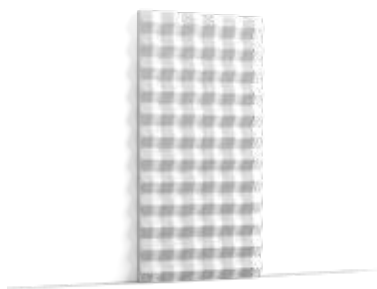
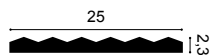

⑤ **W216 MATRIX**

Purotouch®
200 x 25 x 1,6 cm
Designed by Orio Tonini



W219 ZEA NEW

Purotouch®
200 x 25 x 1,9 cm
Designed by Jan Erika

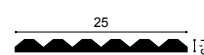

1. CX196 p.146 2. W115 3. CX190 p.118 4. PX198 p.118





5. W216

W112 RIDGE
Purotouch®
200 x 25 x 1,9 cm
Designed by Orio Tonini

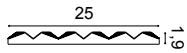

W113 COBBLE
Purotouch®
200 x 25 x 2,2 cm
Designed by Orio Tonini

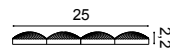

W130 CHEVRON
Purotouch®
200 x 40 x 2 cm

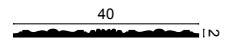

W112 RIDGE + 2x CX190



W113 COBBLE + 2x CX190



W130 CHEVRON + 2x CX190



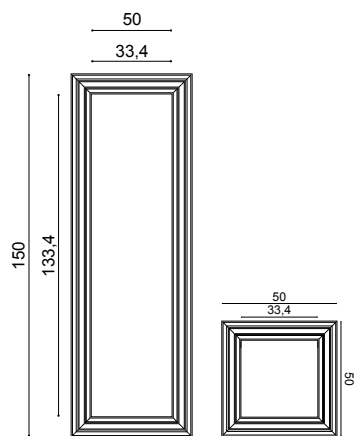

W120 + P4025 + W121
Purotouch®
Designed by Orio Tonini

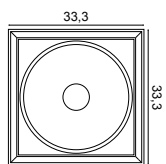
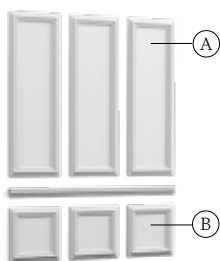

W122 AUTOIRE
Purotouch®
33,3 x 33,3 x 2,6 cm
Designed by Orio Tonini

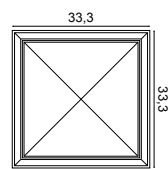

W123 AUTOIRE
Purotouch®
33,3 x 33,3 x 3,5 cm
Designed by Orio Tonini



③ **W120 AUTOIRE**
Purotouch®
50 x 150 x 3,2 cm
Designed by Orio Tonini



W120 + 4*W122
Purotouch®
Designed by Orio Tonini

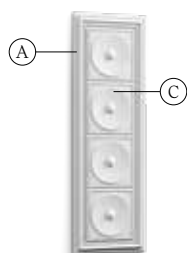

W120 + 4*W123
Purotouch®
Designed by Orio Tonini

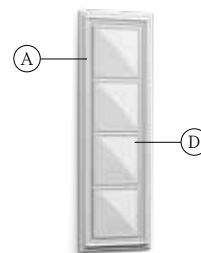

④ **W121 AUTOIRE**
Purotouch®
50 x 50 x 3,2 cm
Designed by Orio Tonini



W121 + W122
Purotouch®
Designed by Orio Tonini

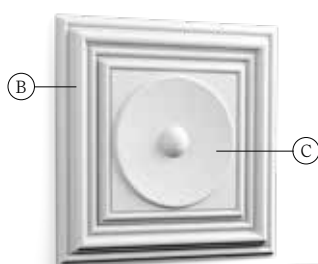

W121 + W123
Purotouch®
Designed by Orio Tonini

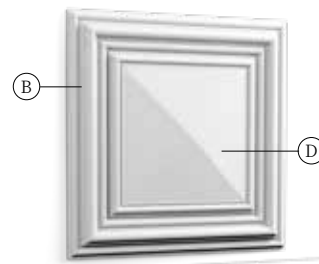

1. DX170-2300 p.158 2. D330LR p.158 3. W120 4. W121 5. SX138 p.115

W124 BURLINGTON NEW

Purotouch®
80 x 50 x 2,2 cm

Designed by *Orio Tonini*



3D Wall covering

W100 ROMBUS
Purotouch®
25,8 x 15 x 2,9 cm

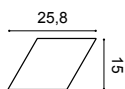

W101 TRAPEZIUM
Purotouch®
34,5 x 15 x 2,9 cm

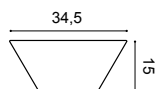

W105 ROMBUS
Purotouch®
30 x 34,6 x 3 cm

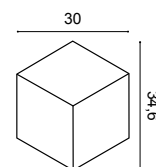

1. W106 2. W107



① **W106 ENVELOP**
Purotouch®
33,3 x 33,3 x 2,9 cm
Designed by Orio Tonini

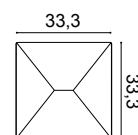

② **W107 CIRCLE**
Purotouch®
33,3 x 33,3 x 2,9 cm
Designed by Orio Tonini

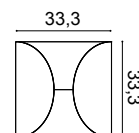

Ceiling ornaments

1. F30



3D Wall covering

F30
Purotouch®
59,5 x 59,5 x 4,3 cm

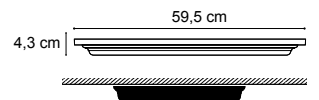



Skirting boards

03



ПЛІНТУСИ
LISTWY PRZYPODŁOGOWE
PLINTE
PODLAHOVÉ LIŠTY

Crafting seamless transitions from floor to wall, from the elegantly ornate to the gracefully understated. We pay meticulous attention to every detail in every design so you can find options that match your vision.

UA —

Ми створюємо плавні переходи від підлоги до будь-якої поверхні, від елегантно оформлених до простих, скромних елементів. У кожному проєкті ми приділяємо увагу до найдрібніших деталей, щоб ви могли знайти варіанти, які відповідають вашому баченню.

PL —

Tworzymy płynne przejścia od podłogi do ściany, od niezwykle ozdobnych po subtelne. Przywiązujemy ogromną wagę do najmniejszych szczegółów w każdym projekcie, abyś mógł znaleźć rozwiązania, które pasują do Twojej wizji.

RO —

Tranziții fluide de la pardoseală la suprafață, de la ornamente elegante la subtilitatea plină de grație. Fiecare design creat de noi este rezultatul unui proces meticulos în care atenția pentru detalii se află mereu în prim-plan, pentru ca dvs. să găsiți opțiunile care se potrivesc cu viziunea dvs.

CZ —

Vytváří plynulé přechody od podlahy k povrchu, od elegantně zdobných po půvabně nenápadné. Do každého designu vkládáme pečlivou pozornost k detailům, abyste mohli najít možnosti, které odpovídají vašim představám.

Three cornerstone skirting families

They invite
you to create.

UA —
Три основні
сімейства плінтусів
Вони запрошують до творчості

PL —
Trzy rodziny listew
przyściennych
Zapraszają do tworzenia

RO —
Trei colecții de plinte de colț
Toate vă invită să creați

CZ —
Tři rodiny soklových lišt
Vyzývají vás k tvorbě



1. SX118 2. PX103 p.131

small

medium

large

Skirting boards

cover

**SX162 | SX162F |
SX162-RAL9003 SQUARE**
Duropolymer®
200 x 4 x 1 cm

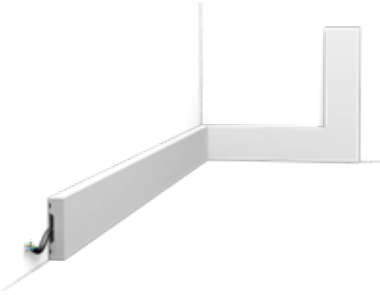

SX182 | SX182F CASCADE
Duropolymer®
200 x 5 x 1,3 cm

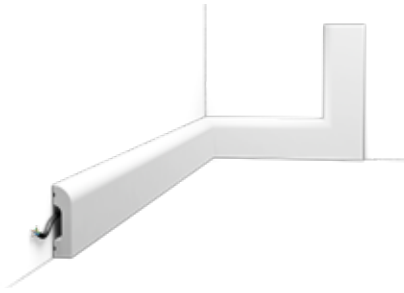

SX165 | SX165F CONTOUR
Duropolymer®
200 x 6,9 x 1,1 cm

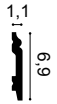

**SX157 | SX157F |
SX157-RAL9003 SQUARE**
Duropolymer®
200 x 6,5 x 1,3 cm

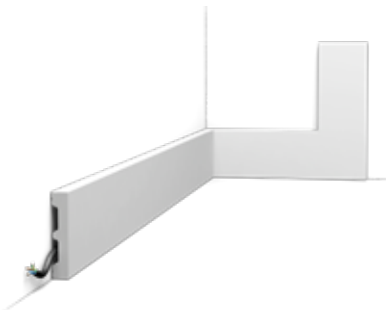

**SX183 | SX183F |
SX183-RAL9003 CASCADE**
Duropolymer®
200 x 7,5 x 1,3 cm

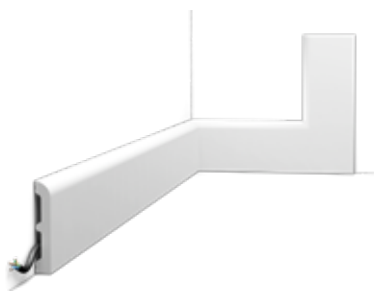

**SX173 | SX173F |
SX173-RAL9003 CONTOUR**
Duropolymer®
200 x 10 x 1,6 cm



**SX163 | SX163F |
SX163-RAL9003 SQUARE**
Duropolymer®
200 x 10,1 x 1,3 cm

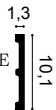

**SX184 | SX184F |
SX184-RAL9003 CASCADE**
Duropolymer®
200 x 11 x 1,3 cm

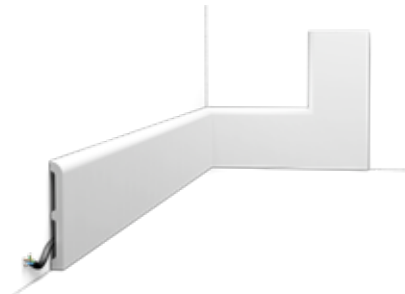
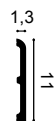

**SX118 | SX118F |
SX118-RAL9003 CONTOUR**
Duropolymer®
200 x 13,9 x 1,8 cm



SX171 | SX171-RAL9003 SQUARE
Duropolymer®
200 x 10 x 2,2 cm



SX185 CASCADE
Duropolymer®
200 x 12 x 2,5 cm

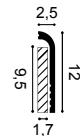

SX186 CONTOUR
Duropolymer®
200 x 13,8 x 2,2 cm

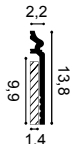

Square

Cascade

Contour

SX195 | SX195F HAMBURG
 Duopolymer®
 200 x 8 x 1,9 cm



SX105 | SX105F
 Duopolymer®
 200 x 11 x 1,3 cm

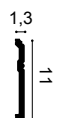

④ SX155 | SX155F
 Duopolymer®
 200 x 10,8 x 2,5 cm

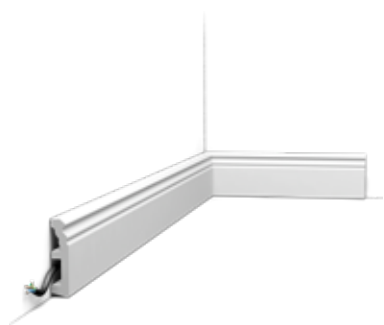

¹ DX170-2300 p.158 ² P9010 p.126 ³ P9050 p.128 ⁴ SX155





SX137 | SX137F
Duropolymer®
200 x 10 x 1,5 cm



1. **W120** p.106 2. **W121** p.106 3. **W122** p.106 4. **W123** p.106 5. **P4025** p.126 6. **SX138** p.115

SX138 | SX138F
Duropolymer®
200 x 13,8 x 1,5 cm



SX206 CONTOUR
Duropolymer®
200 x 18 x 1,8 cm



SX193 AUTOIRE
Duropolymer®
200 x 25 x 2,2 cm
Designed by Orio Tonini



Skirting boards

SX187 | SX187F HIGH LINE
 Duropolymer®
 200 x 7,5 x 1,2 cm
 Designed by Pierre Daems



② **SX180 | SX180F HIGH LINE**
 Duropolymer®
 200 x 12 x 1,6 cm
 Designed by Pierre Daems

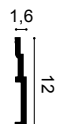

SX181 HIGH LINE
 Duropolymer®
 200 x 20 x 2,2 cm
 Designed by Pierre Daems



¹ P7070 p.128 ² SX180





Skirting boards

3. W120 p.106 4. W121 p.106 5. SX191

SX104 | SX104F
Duopolymer®
200 x 15 x 1,8 cm

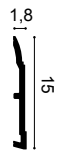

SX156 HIGH HEELS
Duopolymer®
200 x 20,2 x 1,6 cm
Designed by Xavier Donck



⑤ **SX191 HIGH RISE**
Duopolymer®
200 x 21 x 2,1 cm

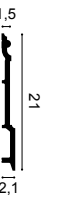

SX194 | SX194F SQUARE
Duopolymer®
200 x 2 x 1 cm

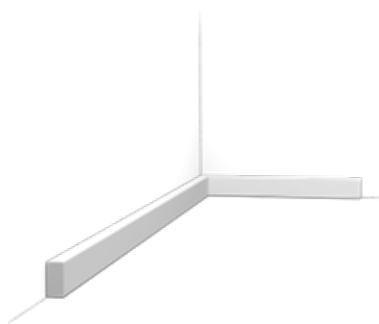

CX132 | CX132F
Duopolymer®
200 x 2 x 2 cm



CX133
Duopolymer®
200 x 2 x 2 cm



③ **CX190 | CX190F U-PROFILE**
Duopolymer®
200 x 3 x 2 cm
Designed by Orio Tonini

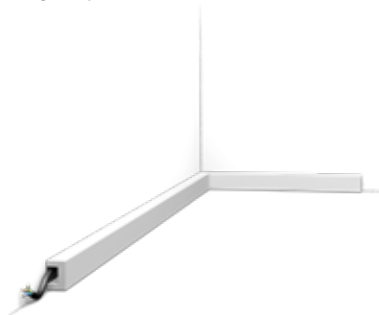

PX198 | PX198F U-STEPS
Duopolymer®
200 x 8,3 x 2 cm
Designed by Orio Tonini



PX198 | PX198F U-STEPS 180°
Duopolymer®
200 x 8,3 x 2 cm
Designed by Orio Tonini



SX159
Duopolymer®
200 x 6 x 1,2 cm

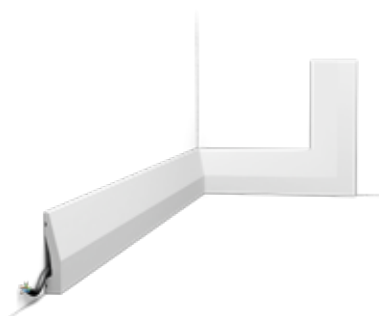

SX125
Duopolymer®
200 x 6,9 x 1,4 cm



SX179 DIAGONAL
Duopolymer®
200 x 9,7 x 2,9 cm
Designed by Orio Tonini

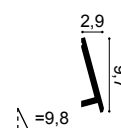

SX172 | SX172F
Duopolymer®
200 x 8,5 x 1,4 cm



SX212 CASCADE
Duopolymer®
200 x 17 x 1,3 cm



¹ C343 p.66 ² P8020 p.126 ³ CX190 ⁴ W109 p.100



Multifunctional

БАГАТОФУНКЦІОНАЛЬНІ ПРОФІЛІ
WIELOFUNKCYJNE
MULTIFUNCTIONAL
MULTIFUNKČNÍ

PX198 | PX198F U-STEPS
Duropolymer®
200 x 8,3 x 2 cm
Designed by Orio Tonini



PX198 | PX198F U-STEPS 180°
Duropolymer®
200 x 8,3 x 2 cm
Designed by Orio Tonini

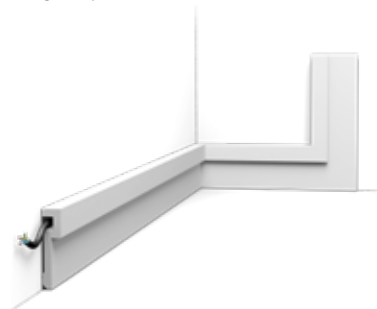

CX190 | CX190F U-PROFILE
Duropolymer®
200 x 3 x 2 cm
Designed by Orio Tonini

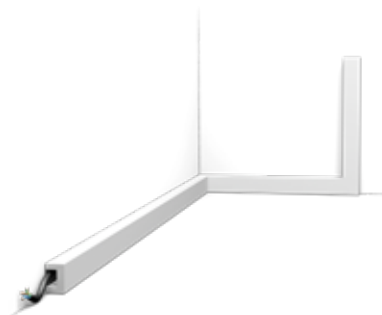

SX159
Duropolymer®
200 x 6 x 1,2 cm

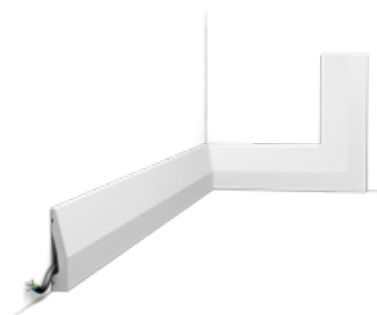

SX194 | SX194F SQUARE
Duropolymer®
200 x 2 x 1 cm

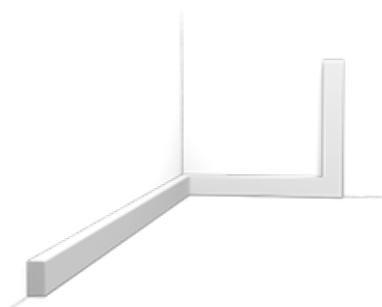

SX162 | SX162F SQUARE
Duropolymer®
200 x 4 x 1 cm

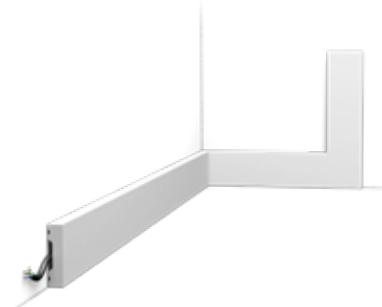

SX157 | SX157F SQUARE
Duropolymer®
200 x 6,5 x 1,3 cm

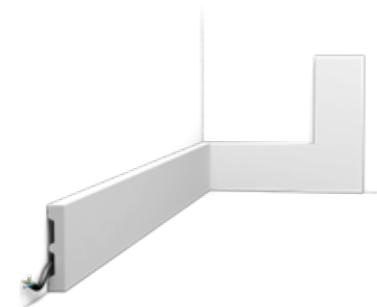

SX163 | SX163F SQUARE
Duropolymer®
200 x 10,1 x 1,3 cm

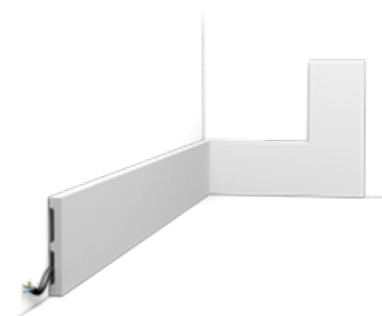
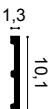

SX168 SQUARE
Duropolymer®
200 x 15 x 1,3 cm

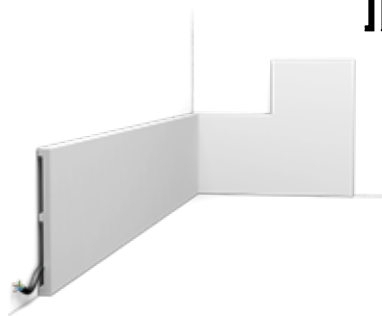
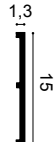

SX207 | SX207F SQUARE
Duropolymer®
200 x 25 x 1,3 cm



SX182 | SX182F CASCADE
Duropolymer®
200 x 5 x 1,3 cm



SX183 | SX183F CASCADE
Duropolymer®
200 x 7,5 x 1,3 cm

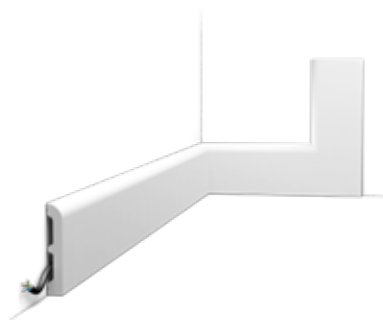

SX184 | SX184F CASCADE
Duropolymer®
200 x 11 x 1,3 cm

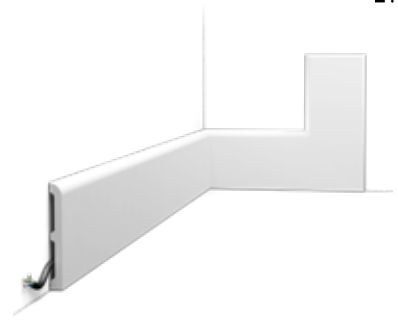
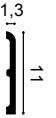

SX187 | SX187F HIGH LINE
Duropolymer®
200 x 7,5 x 1,2 cm
Designed by Pierre Daems



② **SX180 | SX180F** HIGH LINE
Duropolymer®
200 x 12 x 1,6 cm
Designed by Pierre Daems



SX181 HIGH LINE
Duropolymer®
200 x 20 x 2,2 cm
Designed by Pierre Daems



1 P7070 p.128 2 SX180



We embrace limitless possibilities. Our profiles flow seamlessly from a moulding to a door frame, fostering creativity.

UA —
Ми відкриваємо безмежні можливості. Наші профілі трансформуються від молдинга до дверного обрамлення, надихаючи на творчі ідеї.

RO —
Posibilitățile sunt nenumărate. Profilurile noastre transformă tot ce le înconjoară, de la o mură la un cadru de ușă, încurajând creativitatea.

PL —
Otwieramy się na nieograniczone możliwości. Nasze profile przekształcają się od listwy po ramę drzwiową, napędzając tym samym kreatywność.

CZ —
Využíváme neomezené možnosti. Naše profily se přeměňují od lišty až po dveřní obložky a podporují kreativitu.

¹ CX190 p.120





НАКЛАДНІ ПЛІНТУСИ
LISTWA PRZYKRYWAJĄCA
ACOPERIREA PLINTELOR
KRYCÍ PODLAHOVÁ LIŠTA

Cover skirting boards

Skirting boards

Paintable

Фарбується
Można malować
Vopsibil
Přetíratelné

Water resistant

Водостійкий
Wodoodporne
Rezistent la apă
Voděodolné

Ideal for renovations

Легке оновлення інтер'єру
Idealne do renowacji
Ideal pentru revovari
Ideální pro renovace

2. **PX175** p.131 3. **SX185**

SX171 | SX171-RAL9003 SQUARE
Duropolymer®
200 x 10 x 2,2 cm



3. **SX185 CASCADE**
Duropolymer®
200 x 12 x 2,5 cm



SX186 CONTOUR
Duropolymer®
200 x 13,8 x 2,2 cm



Panel mouldings

04



МОЛДИНГИ
PROFILE ŚCIENNE
BRAURI
LEMOVACÍ LIŠTY

An empty wall is like a bare base,
in need of shape and dimension.
Which is why we love to entertain
ideas with these versatile accents.
By using our panel mouldings,
harmony comes into play, a sense
of proportion that is balanced and
pleasing to the eye.

UA —
Пуста стіна — це гола основа,
яка потребує форми та розміру.
Ось чому ми любимо грати з
ідеями та різними акцентами.
Завдяки використанню наших
декоративних молдингів,
досягається гармонія та
збалансоване відчуття міри,
що радує око.

PL —
Pusta ściana jest jak goła podstawa,
która potrzebuje kształtu i wymiaru.
Dlatego uwielbiamy bawić
się pomysłami i igrać z tymi
wszechstronnymi akcentami.
Zastosowanie naszych listew
panelowych zapewnia harmonię,
poczucie proporcji, które jest
zrównoważone i przyjemne dla oka.

RO —
Un perete gol este ca o bază neutră,
care are nevoie de formă și dimensiune.
Acesta este motivul pentru care ne
place să concepem ajutându-ne de
aceste accente ușor adaptabile.
Atunci când folosim mulurile noastre
tip panou, creăm armonie, proporții
echilibrate și plăcute ca aspect.

CZ —
Prázdná stěna je jako holý základ, který
potřebuje tvar a rozměr. Proto se rádi
bavíme nápady s těmito všestrannými
akcenty. Použitím našich panelových
lišť vzniká harmonie, smysl pro
proporce, které jsou vyvážené
a příjemné na pohled.

① **P8030 | P8030F**
Purotouch®
200 x 4,1 x 1,7 cm

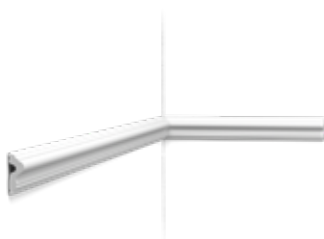

② **P8020 | P8020F**
Purotouch®
200 x 6 x 2,6 cm

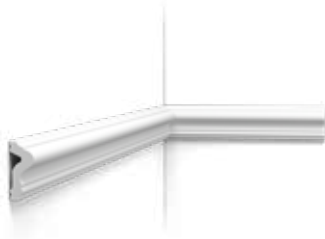

③ **P8050 | P8050F**
Purotouch®
200 x 12 x 3 cm



P4020 | P4020F
Purotouch®
200 x 5 x 2,9 cm

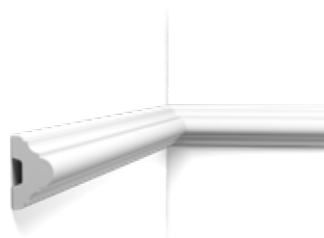

P9040
Purotouch®
200 x 5 x 2,5 cm

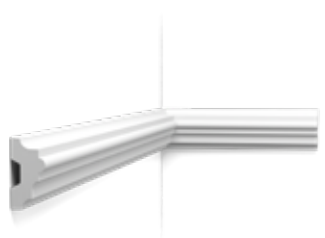

P4025 | P4025F AUTOIRE
Purotouch®
200 x 8,3 x 3,4 cm
Designed by Orio Tonini

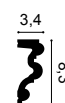

P9010 | P9010F
Purotouch®
200 x 9,1 x 3 cm

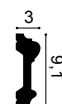

P8040 | P8040F
Purotouch®
200 x 10,1 x 2,2 cm

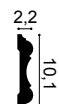

P9020
Purotouch®
200 x 9,6 x 2,1 cm

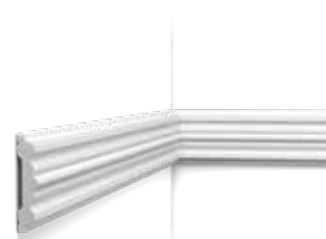

P4000 NEW
Purotouch®
200 x 14,5 x 5,5 cm



P4010 NEW
Purotouch®
200 x 14,5 x 5,5 cm



P1020
Purotouch®
200 x 4,9 x 2,4 cm

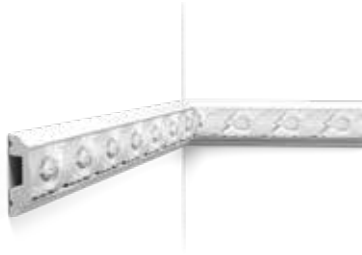

P3020 | P3020F
Purotouch®
200 x 6,1 x 3,2 cm

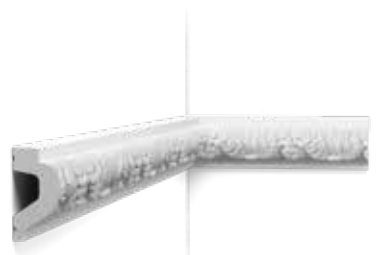

1. P8050 2. P8020 3. P8030



P6020
Purotouch®
200 x 6,4 x 2,8 cm

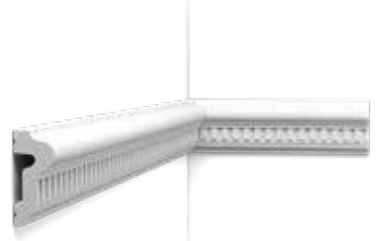

P7030
Purotouch®
200 x 8,5 x 1,7 cm

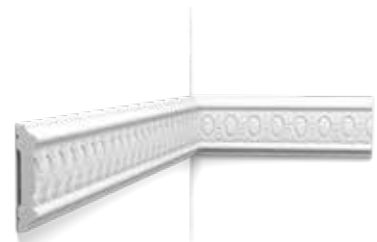

P7020
Purotouch®
200 x 11,1 x 1,9 cm

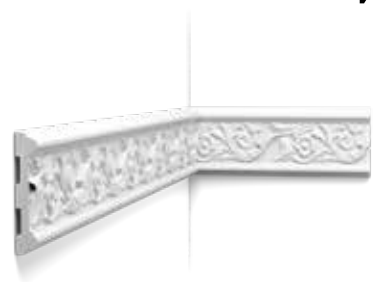
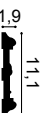

Panel mouldings

② **P9050 | P9050F**
Purotouch®
200 x 2,5 x 1,3 cm



P5021 | P5021F
Purotouch®
200 x 3,1 x 0,9 cm



P7070 | P7070F
Purotouch®
200 x 7,4 x 2,2 cm

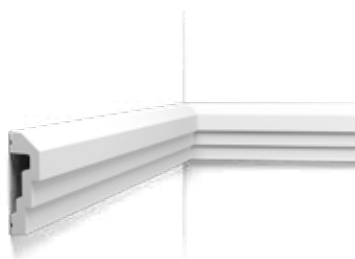

P9900 | P9900F
Purotouch®
200 x 8 x 1 cm

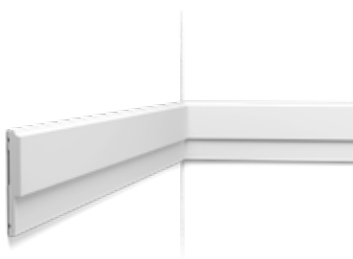

P8060
Purotouch®
200 x 5 x 3,5 cm

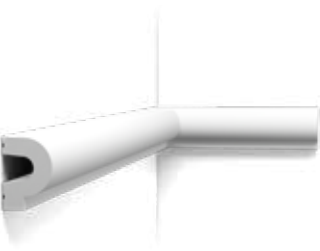

P9901
Purotouch®
200 x 7 x 1,4 cm

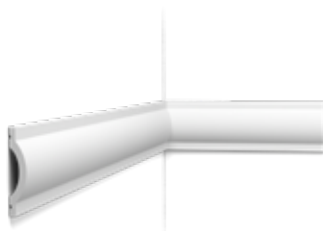

P3070 RADIUS
Purotouch®
200 x 12,5 x 3,2 cm
Designed by Ulf Moritz

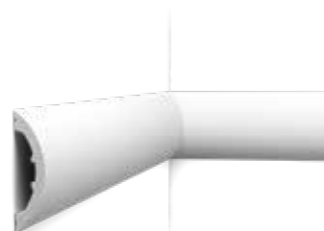
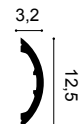

P3071 GOLF
Purotouch®
200 x 37,2 x 7,6 cm
Designed by Ulf Moritz

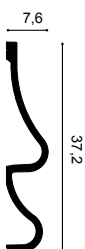



Panel mouldings

1- P9010 p.126 2- P9050 3- SX155 p.114

DX174-2300 | DX174F
 Duropolymer®
 230 x 6 x 2,2 cm (DX174-2300)
 200 x 6 x 2,2 cm (DX174F)



DX170-2300
 Duropolymer®
 230 x 11,9 x 3,2 cm

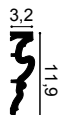

DX119-2300
 Duropolymer®
 230 x 9,2 x 2,2 cm



DX121-2300
 Duropolymer®
 230 x 9,4 x 2,3 cm

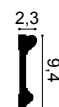

1. P8020 p.126 2. P4020 p.126 3. SX206 p.115



PX103 | PX103F
Duopolymer®
200 x 2,5 x 1,2 cm

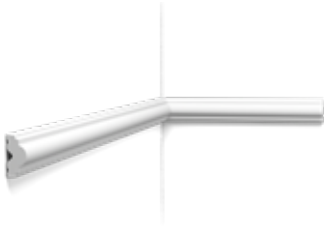

PX120 | PX120F
Duopolymer®
200 x 4 x 1,9 cm



PX201 | PX201F
Duopolymer®
200 x 2,5 x 0,9 cm

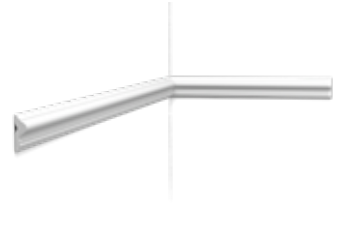

PX175 | PX175F
Duopolymer®
200 x 5 x 1,7 cm

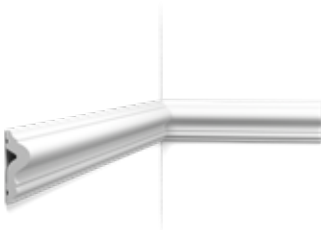

PX202 | PX202F
Duopolymer®
200 x 7,5 x 2 cm



PX116
Duopolymer®
200 x 3,1 x 1 cm



PX117
Duopolymer®
200 x 3,5 x 1,5 cm



PX113
Duopolymer®
200 x 6 x 2,7 cm

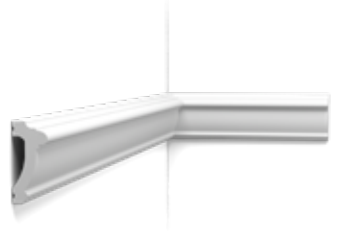

PX144 | PX144F
Duopolymer®
200 x 4,7 x 0,8 cm



SX159
Duopolymer®
200 x 6 x 1,2 cm

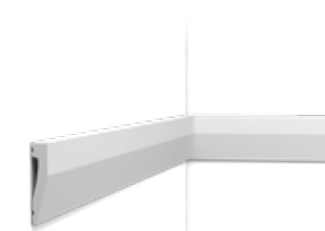



①

②

1. PX209 2. SX207

PX169 ^(A)
Duropolymer®
200 x 5,5 x 3,4 cm

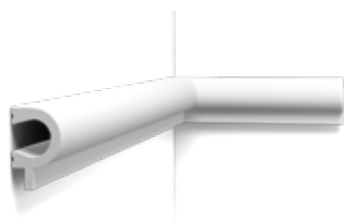

PX147 ^(B)
Duropolymer®
200 x 16,9 x 0,9 cm

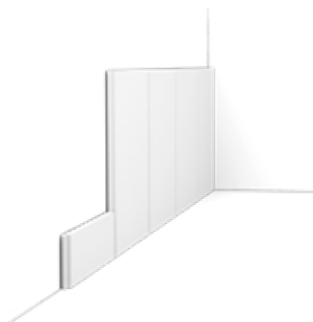

PX169 + PX147



CX190 | CX190F U-PROFILE
Duropolymer®
200 x 3 x 2 cm
Designed by Orio Tonini



PX198 | PX198F U-STEPS
Duropolymer®
200 x 8,3 x 2 cm
Designed by Orio Tonini



CX197 U-STEPS
Duropolymer®
200 x 9,3 x 5 cm
Designed by Orio Tonini

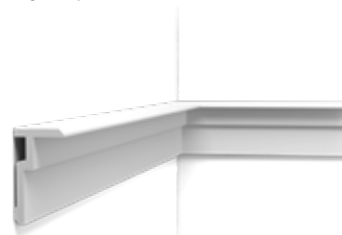
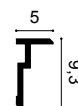

SX194 | SX194F SQUARE
Duopolymer®
200 x 2 x 1 cm

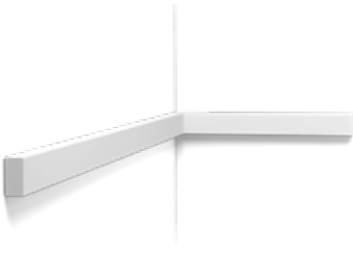

SX162 | SX162F SQUARE
Duopolymer®
200 x 4 x 1 cm

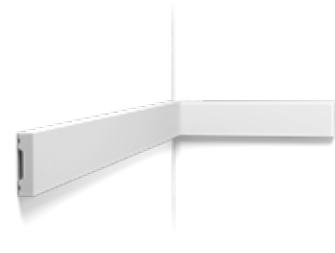

SX157 | SX157F SQUARE
Duopolymer®
200 x 6,5 x 1,3 cm

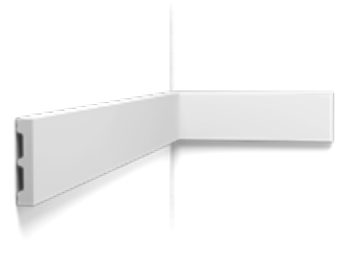

SX163 | SX163F SQUARE
Duopolymer®
200 x 10,1 x 1,3 cm

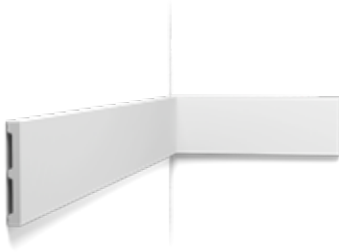
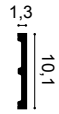

SX168 SQUARE
Duopolymer®
200 x 15 x 1,3 cm

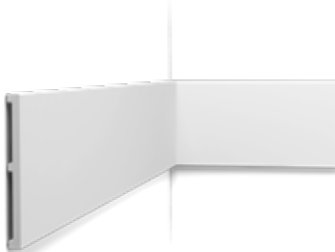
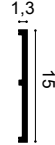

② **SX207 | SX207F SQUARE**
Duopolymer®
200 x 25 x 1,3 cm

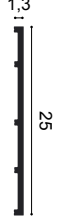

SX182 | SX182F CASCADE
Duopolymer®
200 x 5 x 1,3 cm

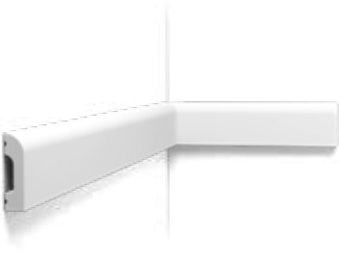

SX183 | SX183F CASCADE
Duopolymer®
200 x 7,5 x 1,3 cm

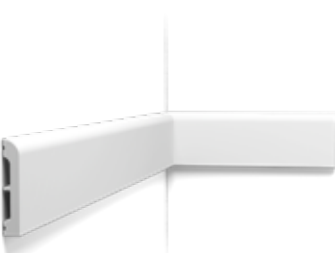

SX184 | SX184F CASCADE
Duopolymer®
200 x 11 x 1,3 cm

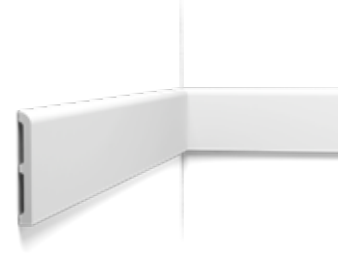
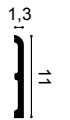

SX212 CASCADE
Duopolymer®
200 x 17 x 1,3 cm

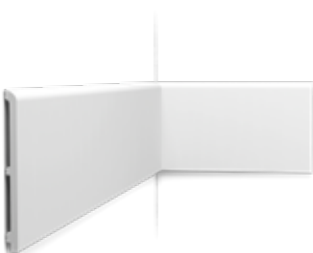

① **PX209 | PX209F RIBBON**
Duopolymer®
200 x 1 x 1,8 cm
Designed by Orio Tonini



CX134
Duopolymer®
200 x 3 x 3 cm

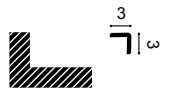

1. P3020 p.127 2. P3020A 3. P8050 p.126



1

2

3

1

P101A + P1020
Purotouch®
24,5 x 24,5 x 2,4 cm

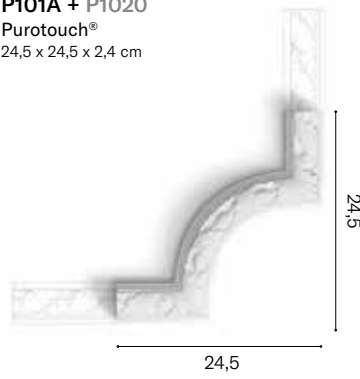

P801C + P8020
Purotouch®
19,8 x 11 x 2,6 cm



P4020A + P4020
Purotouch®
16,4 x 9,1 x 2,9 cm



P3020A + P3020
Purotouch®
42,5 x 42,5 x 4 cm

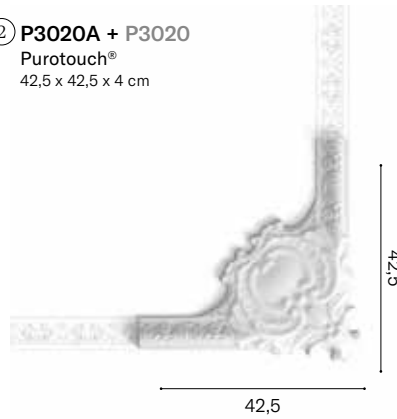

P20 + P101A
Duropolymer®
Ø 6,1 - 0,8 cm

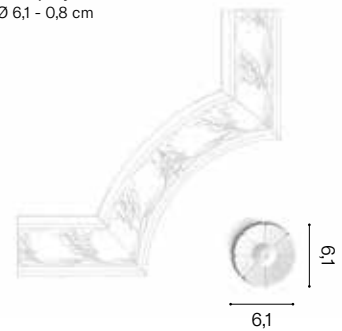

PX103A + PX103
Duropolymer®
19 x 6,8 x 1,5 cm

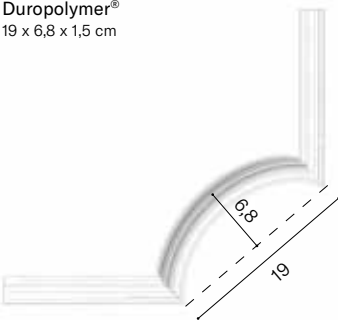

P8030D + P8030
Duropolymer®
13,2 x 13,2 x 1,7 cm

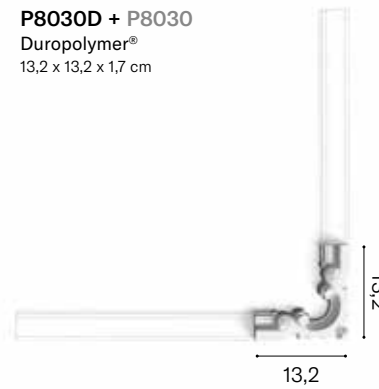

PX120A + PX120
Duropolymer®
20 x 8,8 x 2 cm

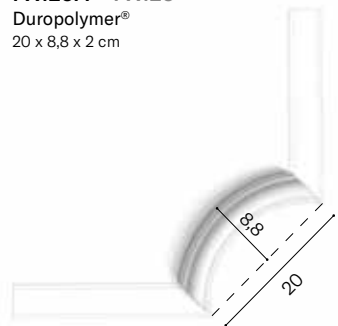

P8030C + P8030
Duropolymer®
19 x 8,6 x 1,7 cm

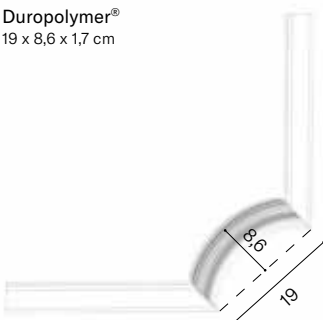

the perfect finish



PG.162-165

Indirect lighting

05

ПРОФІЛІ ДЛЯ LED-ОСВІТЛЕННЯ
LISTWY OŚWIETLENIOWE
ILUMINAT INDIRECT
NEPŘÍMÉ OSVĚTLENÍ

Our indirect lighting solutions are the unseen maestros of ambiance. They are as versatile as they are subtle, designed to enhance every line and curve. So, we encourage you to integrate them as you see fit, for you to create an atmosphere that complements the time of day and the essence of the moment.

UA —

Наші рішення для прихованого освітлення — це майстри створення атмосфери. Вони настільки ж універсальні, як і витончені, створені, щоб підкреслити кожную лінію та вигин. Тож ми заохочуємо вас інтегрувати їх так, як забажаєте, щоб створити атмосферу в потрібний час та момент.

PL —

Nasze rozwiązania oświetlenia pośredniego to skryci mistrzowie tworzenia nastroju. Są równie wszechstronne, co subtelne, zaprojektowane tak, aby podkreślić każdą linię i krzywiznę. Zachęcamy więc do wykorzystania ich według własnego pomysłu, aby stworzyć atmosferę pasującą do pory dnia i charakteru danej chwili.

RO —

Soluțiile noastre de iluminat indirect creează ambianțe deosebite. Sunt adaptabile, dar și subtile, concepute să scoată în evidență fiecare linie și fiecare curbă. Vă încurajăm să le integrați în interiorul dvs. așa cum vă doriți, pentru a crea o atmosferă care completează armonios momentul zilei și esența momentului.

CZ —

Naše řešení nepřímého osvětlení jsou neviditelnými mistry atmosféry. Jsou stejně všestranné jako jemné, navržené tak, aby zvýraznily každou linii a křivku. Proto vám doporučujeme, abyste je začlenili tak, jak uznáte za vhodné, abyste vytvořili atmosféru, která doplňuje denní dobu a podstatu okamžiku.

② **C323**
Purotouch®
200 x 5,5 x 4,2 cm

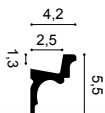

C328 NEW
Purotouch®
200 x 9 x 6,8 cm

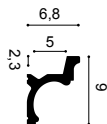

C324 AUTOIRE
Purotouch®
200 x 8,3 x 3,4 cm
Designed by Orio Torini

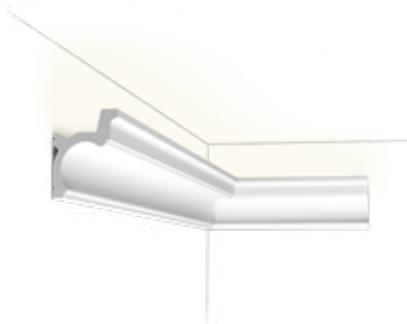

1. W212 p.100 2. C323 3. W109 p.100 4. PX209 p.133 5. SX118 p.113



C357 STRAIGHT
Purotouch®
200 x 7,1 x 11 cm
Designed by Jacques Vergracht

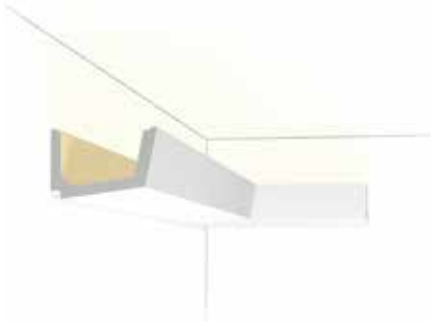
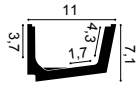

C352 FLAT
Purotouch®
200 x 7,6 x 17,1 cm
Designed by Jacques Vergracht

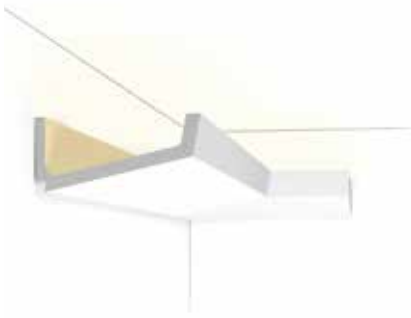
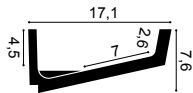

Indirect lighting

6 C902

6 **C902 | C902F**
Purotouch®
200 x 10,3 x 10,3 cm
Designed by Jacques Vergracht

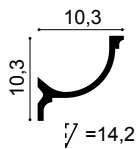

C901 | C901F
Purotouch®
200 x 14,8 x 12,4 cm
Designed by Jacques Vergracht

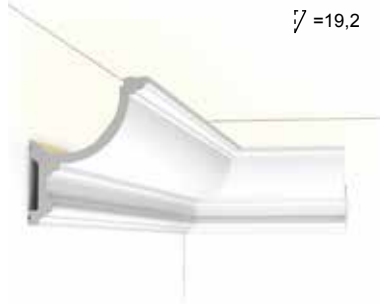
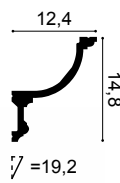

C900
Purotouch®
200 x 17,1 x 14,6 cm
Designed by Jacques Vergracht

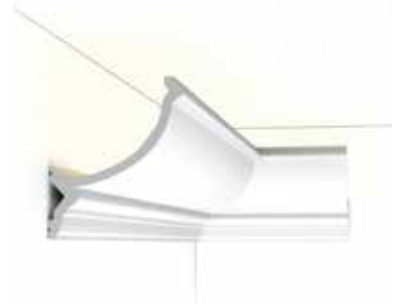

L3 lighting combinations

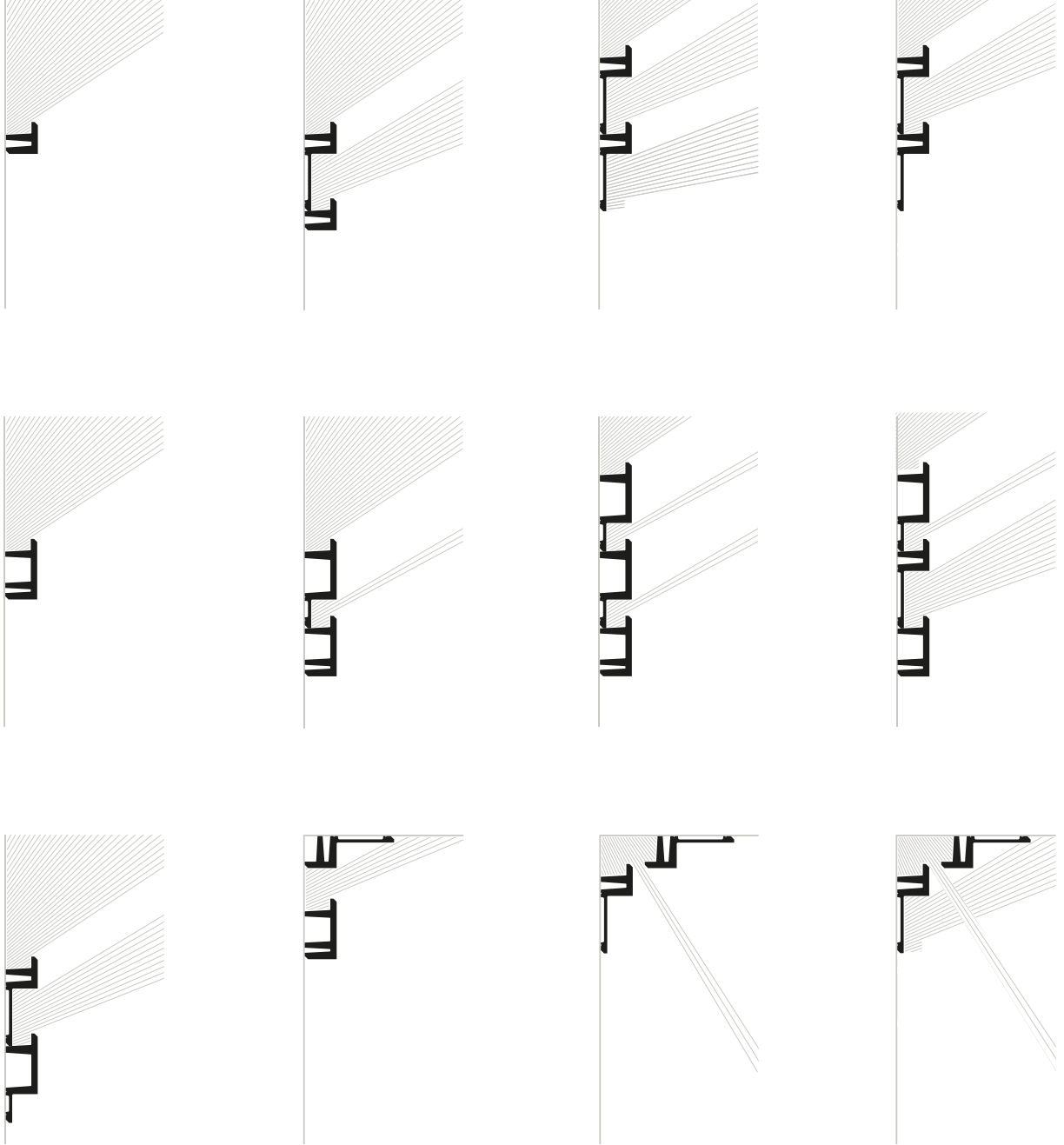



③ **C380** L3 LINEAR LED LIGHTING
Purotouch®
200 x 5 x 5 cm
Designed by Orio Tonini

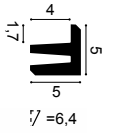

C381 L3 LINEAR LED LIGHTING
Purotouch®
200 x 9,5 x 5 cm
Designed by Orio Tonini

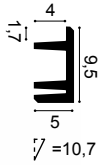

① **C382** L3 LINEAR LED LIGHTING
Purotouch®
200 x 14 x 5 cm
Designed by Orio Tonini

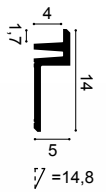

② **C383** L3 LINEAR LED LIGHTING
Purotouch®
200 x 14 x 5 cm
Designed by Orio Tonini

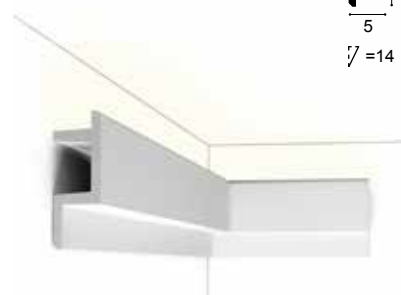
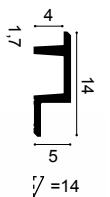

Indirect lighting

1. C394 2. C393 p.79 3. SX180 p.116



C394

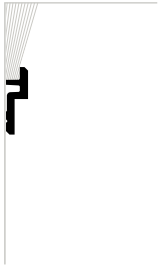

C395

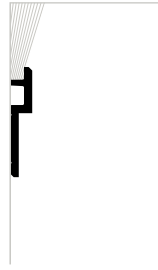

C396

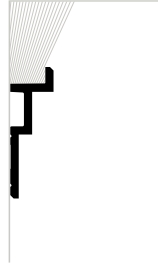

Uplighter

C390

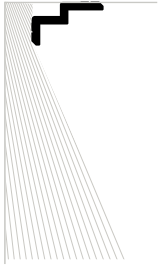

C391

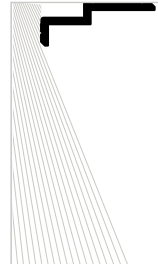

C394

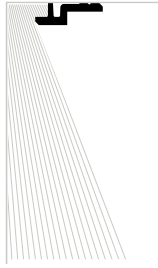

C395

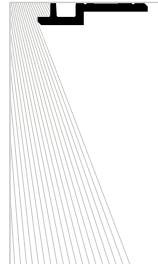

Downlighter

C390 STEPS
Purotouch®
200 x 6 x 10 cm
Designed by Orio Tonini

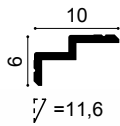

C391 STEPS
Purotouch®
200 x 6 x 16 cm
Designed by Orio Tonini

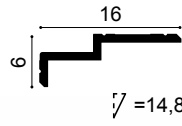

① **C394 STEPS**
Purotouch®
200 x 9,5 x 3,1 cm
Designed by Orio Tonini

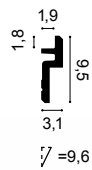

C395 STEPS
Purotouch®
200 x 15,5 x 3,1 cm
Designed by Orio Tonini



C396 STEPS
Purotouch®
200 x 18,5 x 6,1 cm
Designed by Orio Tonini

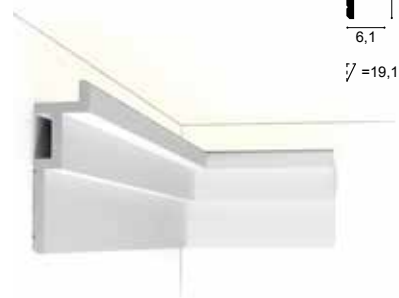
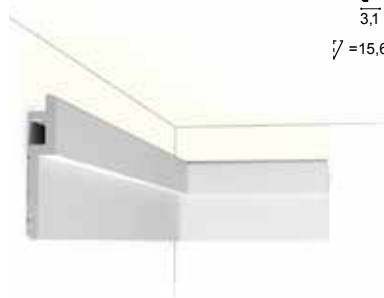
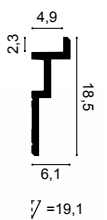

① **CX215-2600** LEDGE (NEW)
 Duopolymer®
 260 x 9,5 x 4,5 cm



CX216-2600 LEDGE (NEW)
 Duopolymer®
 260 x 12,5 x 4,5 cm



CX217-2600 LEDGE (NEW)
 Duopolymer®
 260 x 15,5 x 5 cm



CX215-2600 LEDGE (NEW)
CURTAIN PROFILE
 Duopolymer®
 260 x 9,5 x 4,5 cm



CX216-2600 LEDGE (NEW)
CURTAIN PROFILE
 Duopolymer®
 260 x 12,5 x 4,5 cm



CX217-2600 LEDGE (NEW)
CURTAIN PROFILE
 Duopolymer®
 260 x 15,5 x 5 cm



1. C215 2. SX157 p.113



Indirect lighting

SX179 DIAGONAL
 Duropolymer®
 200 x 9,7 x 2,9 cm
 Designed by Orio Tonini

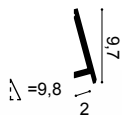

SX179 DIAGONAL
 Duropolymer®
 200 x 9,7 x 2,9 cm
 Designed by Orio Tonini



Use aluminium
 tape or bar for
 LED lighting

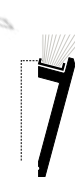

CX197 U-STEPS
 Duropolymer®
 200 x 5 x 9,3 cm
 Designed by Orio Tonini



CX196 U-STEPS
 Duropolymer®
 200 x 11,3 x 4 cm
 Designed by Orio Tonini



CX188 | CX188F
 Duropolymer®
 200 x 3,4 x 3 cm
 Designed by Orio Tonini



CX189 | CX189F
 Duropolymer®
 200 x 2,7 x 2,7 cm
 Designed by Orio Tonini



CX190 | CX190F U-PROFILE
 Duropolymer®
 200 x 2 x 3 cm
 Designed by Orio Tonini



CX190 | CX190F U-PROFILE
 Duropolymer®
 200 x 2 x 3 cm
 Designed by Orio Tonini



CX190 | CX190F U-PROFILE
 Duropolymer®
 200 x 2 x 3 cm
 Designed by Orio Tonini

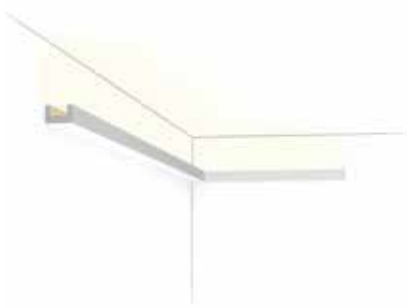



1. CX196 2. W115 p.104 3. CX190 p.120

C373 | C373F ANTONIO
 Purotouch®
 200 x 8 x 5 cm
 Designed by Ulf Moritz



C374 ANTONIO
 Purotouch®
 200 x 18 x 5 cm
 Designed by Ulf Moritz

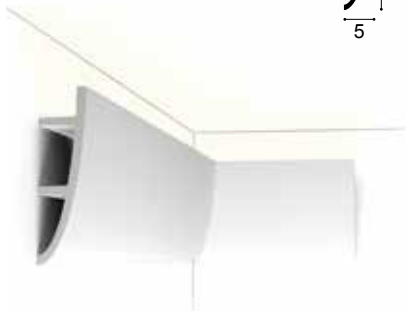
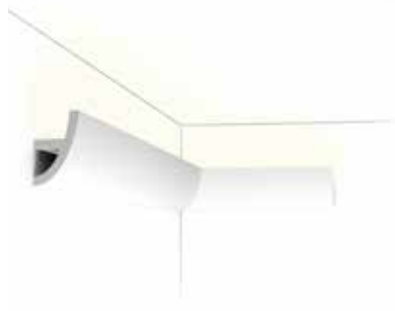
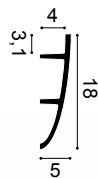

Antonio

C373 + C374

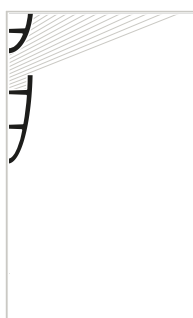

C373 + C373

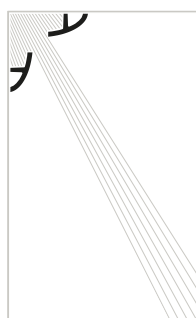

C374 + C991



C373 + C373

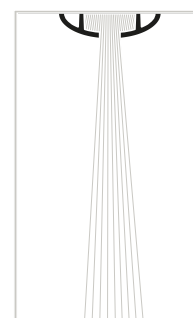

C374 + C374

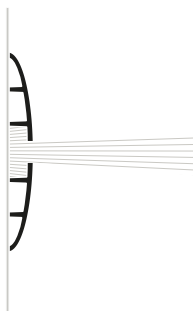

C373 + C374

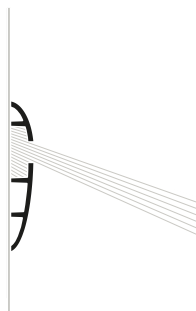

C373 + C373

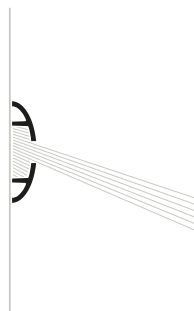

C374 + C373



C373 + C374

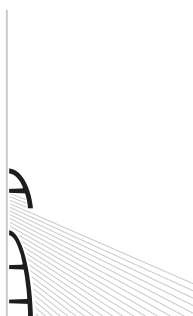

C374 + C374

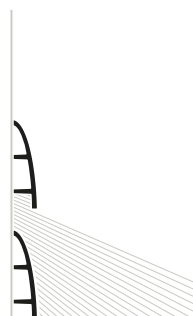

1. PX120 p.131 2. C394 p.77 3. C991 p.78 4. C361 p.150



Indirect lighting

C361 STRIPE
 Purotouch®
 200 x 5 x 5 cm
 Designed by Pierre Daems



C362 CURVE
 Purotouch®
 200 x 5 x 5 cm
 Designed by Pierre Daems

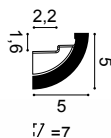

① **C991**
 Purotouch®
 200 x 11 x 14 cm
 Designed by Ulf Moritz

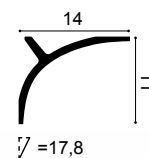

C371 SHADE
 Purotouch®
 200 x 18,5 x 5,8 cm
 Designed by Ulf Moritz

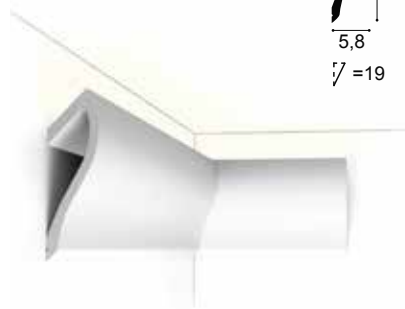
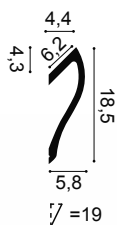

the perfect finish



1. C991



Deco elements

06



ДЕКОРАТИВНІ ЕЛЕМЕНТИ
ELEMENTY DEKORACYJNE
ELEMENTE DECORATIVE
DEKORATIVNÍ PRVKY

Deco elements are the subtle whispers of personality that breathe life into a space. From grandiose flourishes to understated accents, we propose options to punctuate your interior design narrative with finesse, for you to find what feels right.

UA —
Елементи декору — це тонкий шепіт індивідуальності, який вдихає життя в простір. Від грандіозних елементів декору до стриманих акцентів. Ми пропонуємо безліч варіантів, які вигідно підкреслять ваш дизайн інтер'єру.

PL —
Elementy dekoracyjne to subtelne szepty osobowości, które tchną życie w każdą przestrzeń. Od okazałych dodatków po stonowane akcenty — proponujemy opcje, które z finezją podkreślą narrację wystroju wnętrza, aby każdy mógł znaleźć to, co mu odpowiada.

RO —
Elementele decorative sunt indicii subtile ale personalității, care aduc la viață orice spațiu. De la detalii grandioase la accente subtile, vă propunem opțiuni care vor scoate în evidență, cu rafinement, povestea pe care o spune interiorul dvs., pentru ca dvs. să găsiți ceea ce vi se potrivește.

CZ —
Dekorativní prvky jsou jemným vyjádřením osobnosti, které vdechují prostoru život. Nabízíme možnosti, jak jemně obohatit příběh vašeho interiéru, od velkolepých ozdob až po nenápadné akcenty, abyste našli to, co vám bude sedět nejlépe.

Ceiling roses

СТЕЛЬОВІ РОЗЕТКИ
ROZETY
ROZETE
ROZETY

ORAC



1. R64

R10 
Purotouch®

ø 15 x 4,2 - ø 2 cm



R11
Purotouch®
ø 19 x 3,6 - ø 3 cm



R12
Purotouch®
ø 19,5 x 1,8 - ø 1 cm



R13 
Purotouch®
 ø 28 x 3,1 - ø 2,5 cm



R14 
Purotouch®
 ø 33 x 3 - ø 2,5 cm



R31 
Purotouch®
 ø 38,5 x 2,7 - ø 3,5 cm



R17 
Purotouch®
 ø 47 x 3,5 - ø 6,5 cm



R18
Purotouch®
 ø 49 x 4,7 - ø 7 cm



R52 
Purotouch®
 ø 69,5 x 4,8 - ø 12,5 cm



R73 
Purotouch®
 ø 70 x 5,9 - ø 8 cm



R23
Purotouch®
 ø 71 x 4,4 - ø 6 cm



R27
Purotouch®
 ø 75 x 4,5 - ø 9 cm



R22
Purotouch®
 77,5 x 53 x 3,6 cm



R24
Purotouch®
 ø 79 x 6 - ø 8 cm



R64 
Purotouch®
 ø 95,2 x 4,8 - ø 7 cm



R07
Purotouch®
ø 26 x 3 - ø 5 cm



R08
Purotouch®
ø 38 x 4,2 - ø 5 cm



R09 ⊕
Purotouch®
ø 48,5 x 3,7 - ø 6 cm



R76
Purotouch®
ø 62 x 4,1 - ø 10,5 cm



① **R77**
Purotouch®
ø 62 x 4,2 - ø 10,5 cm



R40 ⊕
Purotouch®
ø 74,5 x 3,1 - ø 10 cm

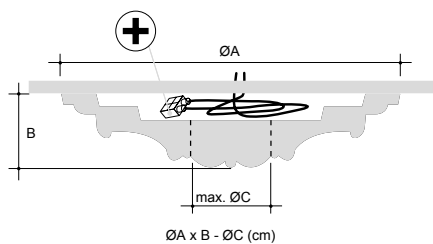

⊕ Room for cables

ВІЙМКА ДЛЯ ДРОТІВ
PRZESTRZEŃ NA KABELE
SPATIU PENTRU CABLURI
PROSTOR PRO KABELY



Deco elements

1. R77

Door frames

ДВЕРНЕ ОБРАМЛЕННЯ
 OBRAMOWANIA DRZWIOWE
 ANCADRAMENTE DE USI
 DVEŘNÍ RÁMY

ORAC



DX157-2300
 Duropolymer®
 230 x 6,5 x 1,3 cm



DX163-2300
 Duropolymer®
 230 x 10,1 x 1,3 cm



1. D170 2. D401 3. DX170-2300 4. D330LR

D210
 Duropolymer®
 9,6 x 9,6 x 3,5 cm



D200
 Duropolymer®
 9,6 x 9,6 x 3 cm

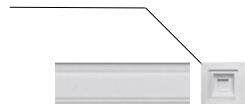

DX121-2300
 Duropolymer®
 230 x 9,4 x 2,3 cm



DX119-2300
 Duropolymer®
 230 x 9,2 x 2,2 cm



3 **DX170-2300**
 Duropolymer®
 230 x 11,9 x 3,2 cm

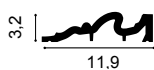

DX174-2300
 Duropolymer®
 230 x 6 x 2,2 cm



D310
 Duropolymer®
 9,5 x 24,9 x 3,1 cm

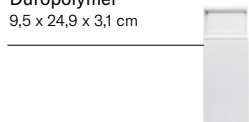

D310
 Duropolymer®
 9,5 x 24,9 x 3,1 cm

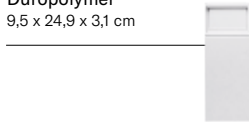

4 **D330LR (2pc)**
 Duropolymer®
 12,6 x 16 x 4,1 cm

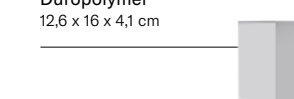

D340
 Duropolymer®
 7 x 11 x 2,5 cm

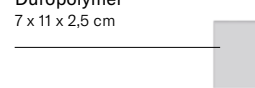

Products

D402
Purotouch®
only for D400 and D401
14,5 x 12 x 5,5 cm



① **D170**
Purotouch®
105 x 24,5 x 3,2 cm



D400
Purotouch®
127,5 x 14,5 x 5,5 cm
Also available in 2m version, see **P4000** p.126



② **D401**
Purotouch®
127,5 x 14,5 x 5,5 cm
Also available in 2m version, see **P4010** p.126



D507
Duropolymer®
55 x 90,5 x 1,7 cm



D503
Duropolymer®
55 x 55 x 1,7 cm



D504
Duropolymer®
55 x 22 x 1,7 cm



Full columns

КОЛОНИ
PEŁNE KOLUMNY
COLOANE INTREGI
PLNÉ SLOUPY

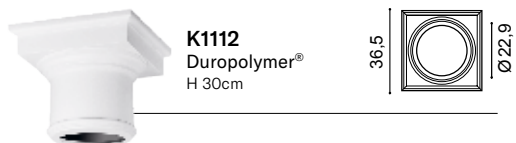

K1112
Duropolymer®
H 30cm



K1122
Duropolymer®
H 30cm

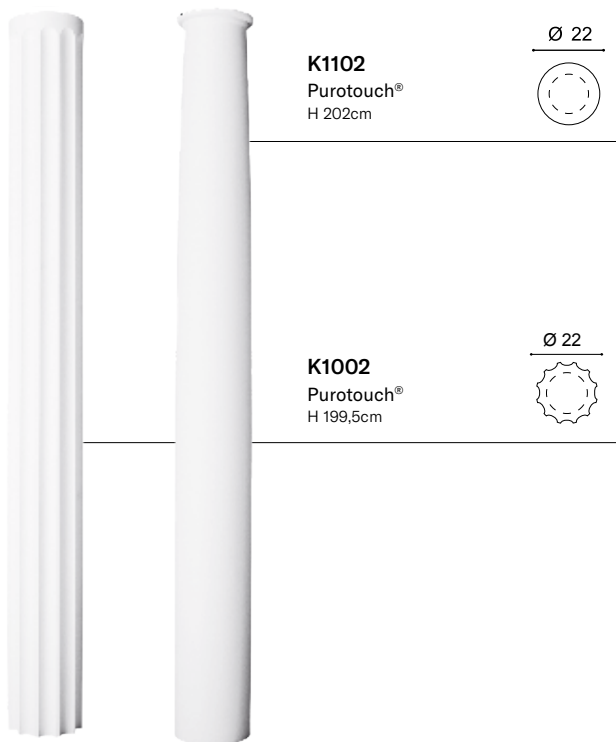

K1102
Purotouch®
H 202cm

K1002
Purotouch®
H 199,5cm



K1152
Duropolymer®
H 12,5 cm

K1132
Purotouch®
H 57,5 cm

K1112 + K1002 + K1152 = 242 cm H
K1112 + K1002 + K1132 = 287 cm H max
K1122 + K1102 + K1152 = 242 cm H
K1122 + K1102 + K1132 = 287 cm H max

ORAC

Half columns

НАПІВКОЛОНИ
PÓŁKOLUMNY
COLOANE JUMATATI
POLOVIČNÍ SLOUPY



K1111
Duropolymer®
H 30cm



K1121
Duropolymer®
H 30cm

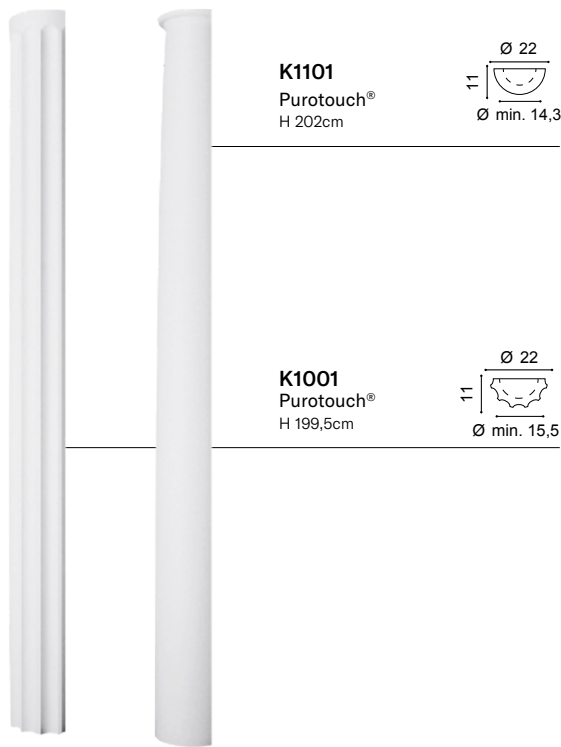

K1101
Purotouch®
H 202cm

K1001
Purotouch®
H 199,5cm



K1151
Duropolymer®
H 12,5 cm

K1131
Purotouch®
H 57,5 cm

K1111 + K1001 + K1151 = 242 cm H
K1111 + K1001 + K1131 = 287 cm H max
K1121 + K1101 + K1151 = 242 cm H
K1121 + K1101 + K1131 = 287 cm H max

Pilasters

1. K1122
2. K1002
3. K1152
4. K251
5. K250
6. K254

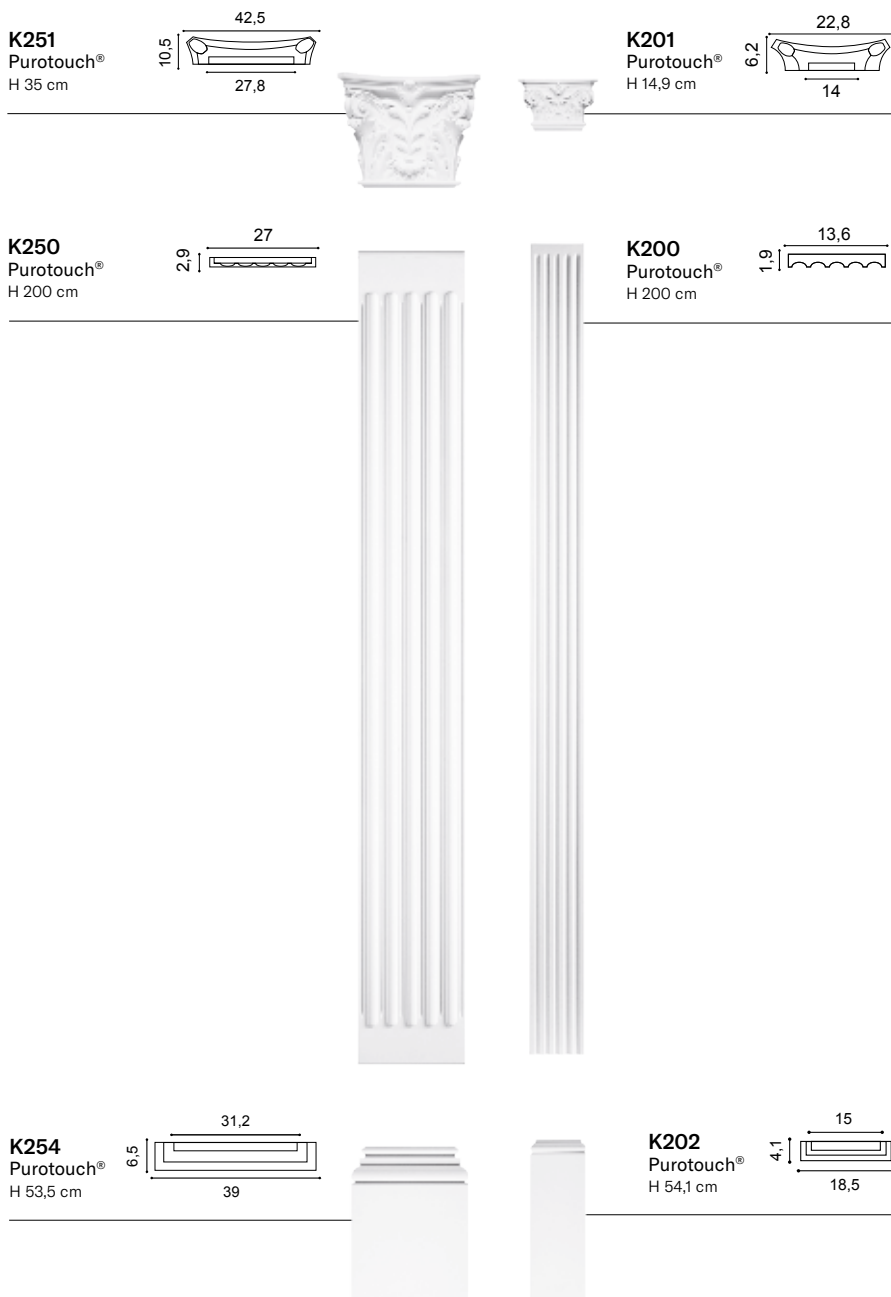

The perfect finish

07



БЕЗДОГАННИЙ РЕЗУЛЬТАТ
IDEALNE WYKOŃCZENIE
FINISARE PERFECTA
PERFEKTNÍ ZAKONČENÍ

We once vowed never to stop at what looks good. That's why our products stand the test of time, right down to the glue that holds them in place. Our installation products are the silent artisans behind the scenes, ensuring a seamless and straightforward installation of our architectural elements.

UA —

Колись ми записягнулися ніколи не зупинятися на тому, що гарно виглядає. Саме тому наша продукція витримує випробування часом, починаючи з клею, який тримає її. Наші монтажні вироби - це мовчазні ремісники, які забезпечують безшовну і просту інсталяцію наших архітектурних елементів.

PL —

Kiedyś przysięgliśmy nigdy nie zadowalać się wyłącznie efektami estetycznymi. Dlatego nasze produkty wytrzymują próbę czasu, wyłącznie z klejem, który je mocuje. Nasze produkty instalacyjne działają jak cisi rzemieślnicy za kulisami, zapewniając płynną i prostą instalację naszych elementów dekoracyjnych.

RO —

Ne-am propus, în trecut, să nu ne oprim doar la aspectul plăcut. Acesta este motivul pentru care nu doar produsele noastre, ci și adezivul cu care sunt fixate, rezistă în timp. Produsele noastre pentru instalare sunt artiștii neștiuți din spatele scenei, care asigură instalarea simplă, fără complicații, a elementelor noastre arhitecturale.

CZ —

Kdysi jsme si slibili, že se nikdy nezastavíme jen u toho, co vypadá dobře. Proto naše produkty odolávají zkoušce časem, a to až po lepidlo, které je drží na místě. Naše instalační produkty jsou tichými pomocníky v pozadí, kteří zajišťují bezproblémovou a jednoduchou instalaci našich architektonických prvků.

Ready?

Surface and atmosphere

ORAC

ПІДГОТОВКА ПОВЕРХНІ ТА НАВКОЛИШНЄ СЕРЕДОВИЩЕ
 POWIERZCHNIA & ATMOSFERA
 SUPRAFATA & AMBIENT
 POVRCH & PODMÍNKY

Storage and installation conditions: Store profiles and adhesives at room temperature and wait 24 hours before installing.



Умови зберігання та монтажу: зберігати профілі та клеї при кімнатній температурі; перед монтажем зачекайте 24 години.

Warunki przechowywania i użycia kleju: profile i kleje przechowywać w temperaturze pokojowej, odczekać 24 godziny przed instalacją.

Conditii de depozitare si instalare: depoziteaza profilele si adevizii la temperatura camerei cu 24h inainte de instalare.

Skladovaci a instalační podminky: skladujte profily a lepidla v pokojové teplotě a vyčkejte 24 hod než začnete instalovat.



Dust free
 Без пилу
 Bez kurzu
 Fara praf
 Bez prachu



Sand and wash surface
 Відшліфувана та чиста поверхня
 Wyszlifowana i umyta powierzchnia
 Suprafata neteda si curata
 Obrušte a očistěte povrch



Flat wall & ceilings
 Рівні стіни та стеля
 Płaska ściana i sufit
 Perete & tavan plat
 Rovná stěna & strop



Dry
 Суха
 Sucha
 Uscat
 Suché



No grease
 Знежирена
 Bez tuszczu
 Fara grasime
 Odmaštěné

Set?

Decofix adhesives

КЛЕЙ DECOFIX
 KLEJE DECOFIX
 ADEZIVI DECOFIX
 DECOFIX LEPIDLA

ONLINE GLUE CALCULATOR



Porous and dry surface
 Робит, пористих та сухих поверхонь
 Do powierzchni porowatych i suchych
 Porosa si uscata
 Porézni a suchý povrch



Heavy profiles or
 Для важких профілів або
 Duże profile lub
 Profile mari si
 Těžký profil nebo



Non-porous and humid surfaces and 3D Wall Covering
 непористих і вологих поверхонь
 Do powierzchni nieporowatych i wilgotnych i panele 3D
 Non-porosa si umeda si panouri decorative 3D
 Neporézni a vlhký povrch



Seal wall/ceiling
 Фіксація до стіни/стелі
 Uszczelnia ścianę / sufit
 Inchidere perete / tavan
 Stěna & strop



DecoFix Pro

Strong, water-based acrylic installation adhesive

FDP500 310ml | 7 > 8m



DecoFix Power

Very strong MS-Polymer-based installation adhesive

FDP700 290ml | 7 > 8m



Joints between mouldings*
 Для з'єднання швів профілів
 Do łączenia listew
 Imbinările dintre profile
 Spoje mezi listami



DecoFix Ultra

Polymer-based adhesive

FX400 270ml | min. 80m



DecoFix Ultra

Polymer-based adhesive

FX400 270ml | min. 80m



Filler & finishing
 Застосування шпаклівки
 Wypełniacz i wykończenie
 Chit și finisare
 Vyplň a konečná úprava



DecoFiller

Acrylic filler

FL300 310ml | > 30m



DecoFiller

Acrylic filler

FL300 310ml | > 30m



Go!

Installation videos & manuals

VISIT WWW.ORACDECOR.COM/INSTALLATION OR SCAN THE QR CODE



DecoFix Pro



FDP500 310ml
> 7 – 8m

Extra strong installation adhesive for porous surfaces and interior applications

- Strong, water-based acrylic glue
- Long-lasting seal between mouldings and the wall and/or ceiling
- Remove with humid sponge or cloth
- Should be kept frost free
- Paintable after hardening (min. 24 hours)

Надміцний клей для внутрішніх робіт та пористих поверхонь

- Міцний акриловий клей на водній основі
- Довговічне з'єднання між профілями та стіною і/або стелею;
- Видаляється за допомогою вологої губки чи ганчірки
- Зберігати в захищеному від морозу місці
- Ліпний декор можна фарбувати після затвердіння (мін. через 24 год.)

DecoFix Power



FDP700 290ml
> 7 - 8m

Extra strong MS polymer glue for new build, non-porous (tiles, glass, ...) surfaces, damp environments and 3D wall covering

- Remove with soap solution
- Paintable after hardening (min. 24 hours)
- Also compatible with our outdoor Xterio collection, which is exclusively available in the UK.

Надміцний полімерний клей для новобудов, непористих поверхонь (плитка, скло тощо), а також для вологих приміщень

- Надлишки видаляються мильним розчином
- Можна фарбувати після затвердіння (мін. через 24 год.)

DecoFix Ultra



FX400 270ml
> 80m

White, polymer-based adhesive for joints between mouldings

- Apply sufficient DecoFix Ultra in every joint.
- Firmly press the profiles together until adhesive comes out slightly. Be careful not to push all glue out of the joint.
- Maintain a small gap (between 0 to 0.2 mm).
- Use a painter's knife to remove excess adhesive.
- Use FL300 DecoFiller if needed and finish with sandpaper.
- Can be painted after 24 hrs.

Білий клей на полімерній основі для стиків профілів між собою

- Нанести достатню кількість DecoFix Ultra на кожен стик.
- Щільно притиснути профілі один до одного, поки клей не почне злегка виступати. Будьте обережні, щоб не виштовхнути весь клей із з'єднання.
- Використовувати малярський ніж для видалення надлишків клею з утвореного невеликого стику (від 0 до 0,2 мм).
- За потреби нанести шпаклівку FL300 DecoFiller та відшліфувати наждачним папером.
- Можна фарбувати через 24 години.

DecoFiller



FL300 310ml
> 30m

Ready to use lightweight acrylic filler

- For shrink-proof finishing of gaps (between decorative profiles after adhesion, between wall and profiles, between walls and between wall and ceiling), cracks and irregularities in profiles or on walls
- Rapidly repaintable (after 15 min.)
- Does not crack

Готова до використання легка акрилова шпаклівка

- Безусадкова, для заповнення щілин (між декоративними профілями після монтажу, між стіною і профілями, між стінами та стіною і стелею), тріщин і виправлення нерівностей на профілях або стінах
- Швидко сохне (готова до фарбування через 15 хв)
- Не розтріскується

Wyjątkowo mocny klej instalacyjny do aplikacji we wnętrzach na porowatych powierzchniach

- Mocny, akrylowy klej na bazie wody
- Długotrwałe uszczelnienie pomiędzy listwami, a ścianami lub sufitami
- Nadmiar usuwać za pomocą wilgotnej gąbki lub szmatki
- Chronić przed mrozem
- Nadaje się do malowania po całkowitym stwardnieniu (min. 24 godz.)

Wyjątkowo mocny klej MS polimerowy do nowych konstrukcji, gładkich powierzchni (plytki, szkło, itp.), w środowiskach wilgotnych oraz do montażu paneli 3D

- Usuwać roztworem z mydła
- Nadaje się do malowania po całkowitym stwardnieniu (min. 24 godz.)

Klej na bazie polimerów, biały, do łączeń między listwami.

- Nanieść odpowiednią ilość DecoFix Ultra na każdym łączeniu.
- Mocno docisnąć listwy jedna do drugiej, aż klej zacznie lekko wypływać. Uważaj, aby nie wypchnąć całego kleju z łączenia.
- Zachowaj niewielką szczelinę (od 0 do 0,2 mm).
- Użyj noża malarskiego, aby usunąć nadmiar kleju.
- W razie potrzeby należy użyć FL300 DecoFiller i wykończyć papierem ściernym
- Można malować po 24 godzinach

Gotowy do użycia lekki wypełniacz akrylowy

- Do niekuczliwego wykańczania szczelin (pomiędzy profilami ozdobnymi po przyklejeniu, między ścianami i profilami, pomiędzy ścianami oraz ścianami i sufitem), a także pęknięć i nierówności w profilach lub na ścianach
- Możliwość szybkiego ponownego malowania (po 15 min.)
- Nie pęka

Adeziv pentru o instalare foarte puternică pe suprafețe poroase și aplicatii la interior

- Puternic, silicon acrilic pe baza de apă
- Lipire de lungă durată între profile și pereți și/sau tavan
- Se îndepărtează cu un burete umed sau o carpa.
- A se feri de îngheț
- Vopsirea se face după întarire (min. 24h)

Silicon MS polimer foarte puternic pentru construcție nouă, suprafețe non-poroase (gresie, sticlă, ...) și medii umede și panouri decorative 3D

- Se îndepărtează cu soluție de săpun
- Vopsirea se face după întarire (min. 24h)

Adeziv pe bază de polimer alb pentru îmbinări între profile

- Aplicați suficient DecoFix Ultra în fiecare îmbinare
- Presați ferm profilele până când adezivul iese puțin la iveală. Aveți grijă să nu împingeți tot adezivul afară din îmbinare.
- Mențineți un spațiu mic (între 0 și 0,2 mm). Folosiți un cuțit pentru pictură pentru a îndepărta excesul de adeziv.
- Folosiți FL300 dacă este necesar și finisați cu șmirghel
- Poate fi vopsit după 24 de ore

Chit acrilic gata de utilizare

- Pentru finisarea rezistentă la contracție a gurilor (între profile decorative după lipire, între pereți și profile, între pereți și între pereți și tavan), fisuri și neregularități în profile sau pe pereți
- Revopsit rapid (după 15 min.)
- Nu crapă

Mimořádně silné montážní lepidlo pro porézní povrchy a pro použití v interiéru

- Silné akrylátové lepidlo na vodní bázi
- Dlouhodobé spojení mezi listou a stěnou nebo stropem
- Odstranění pomocí navlhčené houbyčky nebo hadříku
- Chaňte před mrazem
- Po zatvrdnutí přetřítelné (min. za 24 hodin)

Mimořádně silné polymerové lepidlo pro nová vystavba, pro neporézní povrchy (dlaždice, sklo...) a vlhke prostředí a 3D nástěnné obložení

- Odstranění mýdlovým roztokem
- Po zatvrdnutí přetřítelné (min. za 24 hodin)

Polymerové lepidlo, bílé, pro spoj mezi listami

- Do každého spoje naneste dostatečné množství DecoFix Ultra
- Profily k sobě pevně přitiskněte, až se lepidlo mírně vytlačí. Dejte pozor, aby nedošlo k vytlačení všeho lepidla ze spoje.
- Udržujte malou mezeru (0 až 0,2 mm). K odstranění přebytečného lepidla použijte malířský nůž.
- V případě potřeby použijte DecoFiller FL300 a přebruste brusným papírem
- Lze natírat po 24 hodinách

Lehký akrylový tmel, připravený k použití

- Pro úpravu spár bez smřtování (mezi dekorativními profily po lepení, mezi stěnou a profily, mezi stěnami navzájem a mezi stěnou a stropem), na praskliny a nedokonalosti profilů nebo stěny a stropu), praskliny a nerovnosti v profilech nebo na stěnách
- Rychle přetřítelné (po 15 minutách)
- Nepraská

Tools

ИНСТРУМЕНТЫ
NARZĘDZIA
INSTRUMENTE
NÁSTROJE



FB15

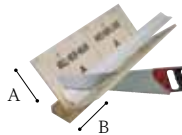

FB300
A: 29,7 cm | B: 29,1cm

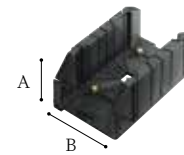

FB13
A: 12,5 cm | B: 15,5 cm

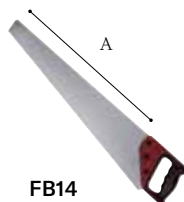

FB14
A: 60 cm

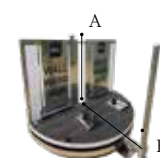

Flexible products

08

ГНУЧКІ ПРОФІЛІ
PRODUKTY ELASTYCZNE
PRODUSE FLEXIBILE
OHEBNÉ PRODUKTY

You may expect walls to be straight by nature. But we invite you to imagine a flowing interior. Many of our solutions are flexible, following or effectively suggesting a curve in a wall. As far as we're concerned, a rounded corner should never be out of the question.

UA —

Ви могли звикнути до того, що стіни мають бути рівними. Але ми пропонуємо вам уявити інтер'єр з вигинами на стінах. Багато наших профілів є гнучкими, вони повторюють або ефектно підкреслюють непрямі форми. Тому для нас це особливе місце, яке не можна залишити без уваги.

PL —

Można oczekiwać, że ściany będą proste z natury. Zachęcamy jednak, by wyobrazić sobie płynne wnętrze. Wiele z naszych rozwiązań jest elastycznych: podążają one za krzywizną ściany lub skutecznie ją sugerują. Dla nas zaokrąglony narożnik nigdy nie powinien być wykluczony.

RO —

Poate vă așteptați ca pereții să fie mereu drepti. Vă invităm să vă imaginați un interior cursiv. Multe dintre soluțiile noastre sunt flexibile și urmează - sau chiar sugerează - o linie curbă a unui perete. Pentru noi, un colț rotund nu este de domeniul imposibilului.

CZ —

Možná očekáváte, že stěny budou od podstaty rovné. My vás však vyzýváme, abyste si představili proměnlivý interiér. Mnohá naše řešení jsou flexibilní a sledují nebo efektně naznačují křivku stěny. Protože pro nás by zaoblený tvar stěny neměl být nikdy vyloučen.

Overview radius of bending

ОГЛЯД РАДІУСУ ВИГІНУ

TABELA GIĘCIA PRODUKTÓW FLEX

PREZENTARE GENERALĂ A RAZEI DE CURBURA

PŘEHLED POLOMĚRŮ OHYBU

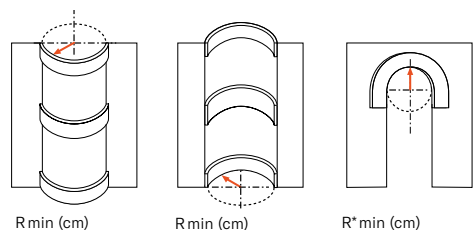

R min (cm)

R min (cm)

R* min (cm)

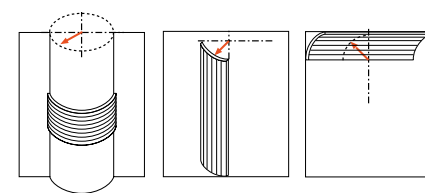

R min (cm)

R** min (cm)

R** min (cm)

Flex Radius	R min (cm)	R* min (cm)	Flex Radius	R min (cm)	R* min (cm)	Flex Radius	R min (cm)	R* min (cm)	Flex Radius	R min (cm)	R* min (cm)	Flex Radius	R min (cm)	R** min (cm)
C211F	250		CX100F	200		SX104F	40		P3020F	50	180	W108F	30	40
C213F	280		CX106F	360		SX105F	30		P4020F	40	200	W109F	30	40
C215F	160		CX109F	160		SX118F	40		P4025F	70		W110F	30	40
C217F	380		CX110F	180		SX137F	40		P5021F	20	70	W111F	30	40
C220F	400		CX123F	280		SX138F	40		P7070F	30	230	W114F	30	40
C230F	150		CX124F	160		SX155F	30		P8020F	40	130	W116F	30	40
C240F	270		CX127F	240		SX157F	35	260	P8030F	20	70	W119F	30	40
C250F	70		CX188F	110		SX162F	20	80	P8040F	30		W214F	30	40
C321F	140		CX189F	90		SX163F	35		P8050F	80	200			
C333F	300		CX190F	30	130	SX165F	40		P9010F	40	310	WX205F	30	40
C334F	380		CX199F	200		SX172F	35		P9050F	20	60	WX210F	30	40
C339F	380					SX173F	45		P9900F	20	250	WX211F	30	40
C341F	400					SX180F	45					WX213F	30	40
C373F	100					SX182F	35	100	PX103F	20	80	WX218F	30	40
C901F	600					SX183F	40		PX120F	30	110			
C902F	600					SX184F	45		PX144F	20	220			
						SX187F	40		PX175F	30	80			
						SX194F	25	80	PX198F	70				
						SX195F	30		PX201F	30	80			
						SX207F	40		PX202F	60	150			
									PX209F	20	70			
						DX174F	60	300						

R min (cm)

R* min (cm)

R* min (cm)

R** min (cm)



SX180F | SX180



PX103F | PX103A | PX103 | C338B



P9010F | P9010



W110F | W110



¹ W108F p.98

Index

C

C200	69
C201	73
C211 C211F	40, 41, 42, 50, 51, 70, 71
C212	73
C213 C213F	69, 70
C215 C215F	69
C216	69
C217 C217F	69
C219	73
C220 C220F	69
C230 C230F	69
C240 C240F	76
C250 C250F	76
C260	76
C301	69
C303	73
C304	73
C305	40, 41, 42, 50, 51, 70, 71
C305 + C211	40, 41, 42, 50, 51, 70, 71
C305 + C213	70
C307	70
C307 + C307A	70
C307A	40, 41, 42, 50, 51, 70, 71
C321 C321F	74
C322	69
C323	138
C324	138
C325	67
C326	67
C327	67
C328 <small>NEW</small>	69, 138
C331	73
C332	34, 35, 36, 37, 74, 75
C333 C333F	73
C334 C334F	73
C336	68
C338	68
C338A	68
C338B	68
C339 C339F	74
C340	74, 83
C341 C341F	66, 83
C342	66, 83
C343	46, 47, 52, 53, 66, 83, 119
C344	66
C352	139
C353	80
C354	80
C355	80, 81
C356	80
C357	139
C360	80
C361	149, 150
C362	150
C371	150
C373 C373F	148
C374	148

C380	141
C381	141
C382	141
C383	141
C390	27, 79, 83, 143
C391	25, 26, 30, 79, 83, 143
C392	27, 79
C393	25, 26, 30, 79
C394	30, 79, 83, 143, 149
C395	79, 83, 143
C396	79, 83, 143
C400	80
C422	70
C602	80
C900	73, 139
C901 C901F	73, 139
C902 C902F	73, 139
C990	14, 15, 76, 77
C990 + 2x P9900	77
C990 + P9900	77
C991	77, 81, 83, 149, 150
C991 + 2x P9900	31, 77
C991 + P9900	77
CB500N	92
CB501N	92
CB502N	92
CB503N	93
CB510N	92
CB511N	92
CB512N	92, 93
CB520N	92
CB521N	92
CB522N	92
CB523N	92
CB524N	93
CB525N	92
CX100 CX100F	84
CX106 CX106F	84
CX107	87
CX108	87
CX109 CX109F	88
CX110 CX110F	84
CX111	87
CX112	87
CX115	88
CX123 CX123F	84
CX124 CX124F	84
CX126	88
CX127 CX127F	84
CX129	87
CX132	88
CX133	88
CX134	133
CX141	88
CX148	88
CX160	54, 91
CX161	91
CX176	88
CX177	87
CX188 CX188F	14, 15, 30, 31, 76, 146
CX189 CX189F	148

CX190 CX190F	18, 19, 25, 26, 28, 29, 89, 103, 105, 118, 120, 122, 132, 146, 147
CX192	88
CX196	83, 89, 104, 144
CX197	83, 89, 132, 144
CX199 CX199F	86
CX215-2600 <small>NEW</small>	84, 85, 88, 144
CX216-2600 <small>NEW</small>	84, 85, 88, 144
CX217-2600 <small>NEW</small>	84, 85, 88, 144

D

D170	158
D200	158
D210	158
D310	158
D330LR	41, 52, 107, 158
D340	158
D400	159
D401	159
D402	159
D503	159
D504	159
D507	159
DX119-2300	130, 159
DX121-2300	130, 159
DX157-2300	159
DX163-2300	159
DX170-2300	41, 52, 107, 114, 130, 158, 159
DX174-2300 DX174F	128, 155

F

F30	109
-----	-----

K

K200	161
K201	161
K202	161
K250	161
K251	161
K254	161
K1001	161
K1002	161
K1101	161
K1102	161
K1111	161
K1112	161

K1121	161
K1122	161
K1131	161
K1132	161
K1151	161
K1152	161

P

P20	135
P101A	135
P801C	135
P1020	127
P3020A	39, 134, 135
P3020 P3020F	127
P3070	128
P3071	128
P4000 <small>NEW</small>	126
P4010 <small>NEW</small>	126
P4020A	135
P4020 P4020F	40, 41, 42, 46, 52, 126, 130
P4025 P4025F	126
P5021 P5021F	128
P6020	127
P7020	125
P7030	127
P7070 P7070F	27, 116, 121, 128
P8020 P8020F	46, 52, 66, 67, 75, 84, 119, 126, 127, 129
P8030C	135
P8030D	135
P8030 P8030F	38, 39, 51, 54, 67, 71, 84, 90, 126, 127
P8040 P8040F	126
P8050 P8050F	39, 50, 126, 127, 134
P8060	128
P9010 P9010F	48, 49, 112, 126, 129
P9020	126
P9040	126
P9050 P9050F	48, 49, 114, 128, 129
P9900 P9900F	24, 31, 77, 128
P9901	128
PX103 PX103F	93, 112, 131
PX103A	135
PX113	131
PX116	131
PX117	131
PX120 PX120F	131
PX120A	135
PX144 PX144F	131
PX147	132
PX169	132
PX175 PX175F	131
PX198 PX198F	89, 104, 118, 120, 132
PX201 PX201F	131
PX202 PX202F	131
PX209 PX209F	14, 15, 36, 99, 100, 101, 132, 133, 138

R

R07	156
R08	156
R09	156
R10	154
R11	154
R12	154
R13	155
R14	155
R17	155
R18	155
R22	155
R23	155
R24	155
R27	155
R31	155
R40	156
R52	155
R64	155
R73	155
R76	156
R77	156

S

SX104 SX104F	117
SX105 SX105F	114
SX118 SX118F	95
SX125	118
SX137 SX137F	115
SX138 SX138F	34, 36, 37, 107, 115
SX155 SX155F	48, 114
SX156	117
SX157 SX157F	91, 113, 120, 133, 145
SX159	128
SX162 SX162F	91, 113, 120, 133
SX163 SX163F	91, 113, 120, 133
SX165 SX165F	113
SX168	120, 133
SX171	113, 123
SX172 SX172F	118
SX173 SX173F	113
SX179	118, 146
SX180 SX180F	25, 27, 30, 116, 121, 141, 142
SX181	116, 121
SX182 SX182F	14, 17, 91, 101, 113, 121, 133
SX183 SX183F	91, 113, 121, 133
SX184 SX184F	91, 113, 121, 133
SX185	113, 123
SX186	113, 123
SX187 SX187F	116, 121
SX191	51, 52, 53, 67, 71, 117
SX193	115
SX194 SX194F	19, 24, 91, 118, 120, 133
SX195 SX195F	114

SX206	46, 115, 130
SX207 SX207F	26, 97, 120, 132, 133
SX212	121, 133

W

W100	108
W101	108
W105	108
W106	108
W107	108
W108 W108F	98, 169
W108-2600	98, 169
W109 W109F	48, 49, 100, 119, 138
W109F-2600	48, 49, 100, 119, 138
W110 W110F	20, 21, 36, 98, 99
W110-2600	20, 21, 36, 98, 99
W111 W111F	25, 89, 103
W111-2600	25, 89, 103
W112	105
W113	105
W114 W114F	18, 19, 100
W114-2600	18, 19, 100
W115	16, 104, 145
W116 W116F	25, 89, 103
W119 W119F	25, 89, 103
W120	106, 107, 115, 117
W121	106, 107, 115, 117
W122	106, 107
W123	106, 107
W124 <small>NEW</small>	107
W130	105
W212	100, 138
W213	98, 99
W214 W214F	34, 35, 36, 37, 98, 99
W215	34, 35, 36, 37, 98, 99
W216	26, 104, 105
W217	14, 17, 101
W218	14, 17, 101
W219 <small>NEW</small>	104
WX204	97
WX204-2600	97
WX205 WX205F	97
WX205-2600	97
WX210 WX210F	36, 97, 99
WX210-2600	36, 97, 99
WX211 WX211F	36, 97, 99
WX211-2600	36, 97, 99
WX213 WX213F <small>NEW</small>	97, 99
WX213-2600 <small>NEW</small>	97, 99
WX218 WX218F <small>NEW</small>	97, 99
WX218-2600 <small>NEW</small>	97, 99

Colofon

Concept

Base Design
zworm.studio

Graphic design

Beau De Maesschalck

Special thanks to

BLCN Design	blcn-design.com	8
The HUB Ghent	thehub.be	18–19
The Room Studio	theroom-studio.com	12, 15, 56
Maison Numéro 20	maisonnumero20.fr	20–21
Atelier DAAA	atelierdaaa.com	28–29, 90, 122
Marie-Emilie Geerinckx	marieemiliegeerinckx.be	30–31, 142
Aboco	aboco.be	38–39, 134
Geoffroy Van Hulle	geoffroyvanhulle.com	40–41, 42–43, 54–55, 76, 84
Van Damme - Vandeputte architects	vandammevandeputte.com	50–51, 71, 124, 127
LOFT4C	loft4c.be	52–53
Anthony Boelaert	anthonyboelaert.be	68
Interieurprojects	interieurprojects.com	81
Sur Mesure Interieur	surmesure-interieur.be	75, 82
Sofie de Kruijff	thomestyleclub.com	100
Atelier En Aparté	atelierenaparté.com	108
Blume Studio	blumestudio.es	109
Madrid Forest	madridforest.com	109
Hotel Du Parc Oostende	hotelduparc.be	112
D-ZAJN	d-zajn.be	112
Hotel Astoria De Haan	hotelastoria.be	117
Roelfien Vos	roelfienvos.com	147, 149
Perfect Living	perfectliving.be	154
Alina Vilhjálmisdóttir		157
Eichholtz	eichholtz.com	161
Belén Imaz	belenimaz.com	109
Cafeine	cafeine.be	18–19, 28–29, 50–51, 71, 90, 117, 122, 124, 127
Damon De Backer	damondebacker.com	43
Didier Delmas	didierdelmas.com	20–21
DVO Photographic	dvo-photographic.be	81
Hannelore Veelaert	hanneloreveelaert.com	8, 38–39, 112, 134
Lotte van Uittert	lottevanuittert.com	100
Rebecka Oftedal		108
Space Content Studio	spacecontent.studio	149, 151
Stephanie Mathias	stephaniemathias.be	75, 82
Tijs Vervecken	tijssvervecken.com	30–31, 40–41, 42–43, 52–53, 54–55, 76, 84, 142
Verne	verne.be	
Willem Van Puyenbroeck	willemvanpuyenbroeck.com	154
Maud Lebossé Testud		168

Guarantee terms and conditions apply if provided installation instructions have been followed to the letter. Fire retardant standards. In many interiors and projects strict fire regulations are imposed. Therefore, ORAC has implemented a number of solutions depending on the country and its regulations. Please contact us for more information. The information in this catalogue is without engagement. Changes and discrepancies in sizes or/and shapes against those stated in the catalogue can occur. This catalogue and the design embodied within are protected by copyright law and international treaties. Unauthorized reproduction of the catalogue, any portion of it or the reproduction of the designs embodied therein may result in severe civil and criminal penalties and will be prosecuted to the maximum.

Further legal information can be found on: www.oracdecor.com/nl/disclaimer.



This catalogue is printed on FSC-certified paper.

ORAC Headquarters | nv ORAC sa

Biekorfstraat 32
8400 Ostend, Belgium
T +32 59 80 32 52
info@oracdecor.com

ORAC Benelux

Biekorfstraat 32
8400 Ostend, Belgium
NL: T +31 852 08 40 59
BeLux: T +32 59 79 02 82
benelux@oracdecor.com

ORAC Bulgaria

T +40 (31) 630 06 19
bulgaria@oracdecor.com

ORAC Deutschland

Boltensternstraße 159A
50735 Köln, Deutschland
T +49 221 747 499 39
deutschland@oracdecor.com

ORAC España

C/ del Rosselló, 229
08008 Barcelona, España
T +34 938 56 49 00
spain@oracdecor.com

ORAC Estonia

T +372 58 55 8668
eesti@oracdecor.com

ORAC Export

T +32 59 79 02 83
export.cs@oracdecor.com

ORAC France

13 Rue Séguier
75006 Paris, France
T +33 188803631
france@oracdecor.com

ORAC Ireland

T +35 381 8000 280
ireland@oracdecor.com

ORAC Italia srl

Corso Giacomo Matteotti, 5/H
23900 Lecco (LC), Italia
T +39 0341 362062
italia@oracdecor.com

ORAC Latvija

T +371 264 888 31
latvija@oracdecor.com

ORAC Lietuva

T +370 6999 0006
lietuva@oracdecor.com

ORAC Österreich

T +43 662 23 49 27
oesterreich@oracdecor.com

ORAC Polska

ul. Pomorska 106A
91-402 Łódź, Polska
T +48 42 203 60 56
polska@oracdecor.com

ORAC Romania

Blvd. I.C. Bratianu nr. 10, floor 1, district 3
Bucharest, cod 030174, Romania
T +40 31 630 06 19
romania@oracdecor.com

ORAC Schweiz

T 0800 562 118
switzerland@oracdecor.com

ORAC Slovakia s.r.o.

Kpt. Nalepku 6
08271 Lipany, Slovakia
T +421 232 784 952
slovakia@oracdecor.com

ORAC UK ltd.

The Courtyard
30 Worthing Road
Horsham RH12 1SL
T +44 1403 240 102
uk@oracdecor.com

ORAC PRA CO

WWW.ORACDECOR.COM

