

Main Catalogue

Skirting Boards,
Floor Profiles and
Accessories

Issue 1 | May 2025

Döllken Profiles

SURTECO GROUP

New Products

S 60 flex life with short soft lip



New stock availability of S 60 flex life Top

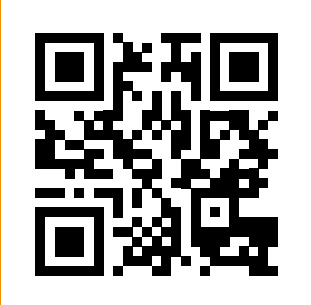
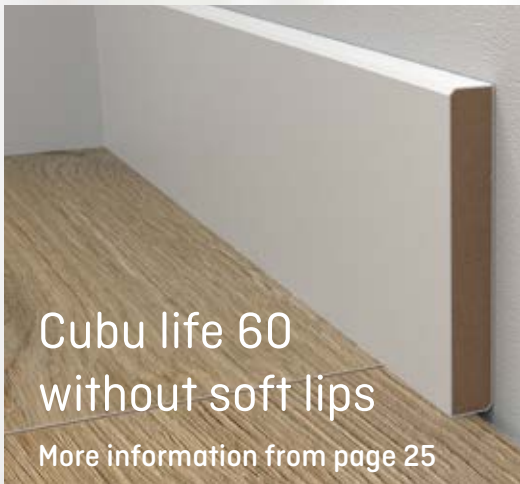

To view important revisions to our range and the latest online version of our catalogue, please visit our website

doellken-profiles.com

The perfect finish for all flooring

Contemporary flooring is very diverse and just as diverse are the various skirting boards in the Döllken Profiles range that provide for the perfect transition between floor and wall. From solidcore skirtings to custom profiles – the individual situation determines which model should be used. Whether the decision is in favour of a plastic-based solution or a high-

quality solidcore skirting board with HDF core, all products are made for and developed with customers so that they meet the needs of professional floor layers. We regularly introduce new, individual collections that are adapted to the latest trends in flooring that use materials such as LVT, laminates and textiles.

From floor to skirting board



Our decor-related skills are one of our main strengths, making us practically unique in our sector. Our decor expertise enables us to translate current trends into successful product solutions. And our decor finder already includes more than 5000 recommended skirting boards

that match well with current flooring collections. With our customer-orientated, sustainable and service-driven approach, we have taken innovative routes in processing and product development.

Looking for a decorative effect that matches your flooring? Simply take a look in our decor finder; go to: www.doellken-profiles.com



Your benefits

... as a floor layer

- 30-50% saving of time using Döllken tools in comparison with other tools
- Long-lasting products complying with the most stringent quality standards
- Our decors are designed to match the collections of many leading flooring manufacturers – we add new designs daily
- It has been demonstrated that Döllken Profiles products are subject to fewer complaints
- All products available at short notice – even express shipments are possible
- Almost 100% applicability thanks to collaboration with nearly all flooring and paint wholesalers in Germany and Austria

What we offer you:

- Free provision of samples of all products
- Free training and workshops
- On-site advice
- Helpful information on installation and instructional videos with numerous tips and step-by-step tutorials (www.doellken-profiles.com/en/processing)
- Many dealers can provide tools on loan or to try out
- Online repair service
- Express and direct shipments through collaboration with distributors
- Customer-orientated communication: give us a call or send us an email

i



Did you know? We offer a wealth of advice and tips on YouTube. Visit us at:
www.youtube.com/DöllkenProfilesGmbH



Your benefits

... as a specialist dealer
and wholesaler

- Products already established on the market
- Regular development of innovations
- Products available at short notice (large stocks of all products)
- On request, we will ship directly to your customers
- Free check of the match between your flooring collection and our skirting boards
- On request, we will include your skirting board recommendations in our decor finder
- Free content for your website, catalogues etc.
- Highly diversified field force for your support
- Help with projects by means of special production of small batch sizes
- Help with architectural aspects in the form of provision of corresponding documentation and samples

What we offer you:

- Our decor finder will enable you to rapidly find matching skirting boards
- Free provision of samples of all products
- Free training of your back office and field force staff
- Tools (punches and hot glue guns) available on loan at attractive prices – 50% discount on listed prices
- Support for your field force; our personnel will accompany them on visits to customers
- Regular events at your premises, such as 'punching days' and 'painter breakfasts' etc.
- Support with marketing of samples, POS design, workshops and much more



Visit us on Facebook and Instagram
and get more useful information!



Key

Environmental protection

At Döllken Profiles, environmental protection plays a major role in the case of our products and production processes.



GREENGUARD Gold Certification
Nearly all Döllken products meet the most stringent and extensive requirements in terms of reduction of emission of chemicals into indoor air and can thus be used in sensitive environments such as schools and health institutes.



Emissions
The levels of emission from all our solidcore skirtings are extremely low. No hazardous organic compounds are released into the air in rooms.



Blue Angel
Nearly all our solidcore skirtings bear the Blue Angel ecolabel.

www.blauer-engel.de/uz176



Other certifications

All our solidcore skirtings are made from chlorine-free plastics, are certified in accordance with ISO 16000 and are low-emission.



All our plastic skirtings are exclusively made using phthalate-free softening agents.



An Environmental Product Declaration (EPD S-P-11728) has been issued that provides information on the environmentally relevant properties of our WLK range in the form of neutral and objective data. The data covers all effects that the products can have on their surroundings. The entire life cycle of the products is taken into account. The EPD was drawn up in compliance with the stipulations of ISO 14025:2006 and EN 15804:2012+A2:2019/AC:2021 and conformity has been confirmed by an independent expert. When it comes to construction, EPDs are important sources used by architects and planners for the holistic design of structures and their evaluation. EPDs also provide critical information required for building certification per the German Sustainable Building Council (DGNB) and the Building Research Establishment Environmental Assessment Method (BREEAM).

Key to icons



Döllken punch



Döllken clamping lever XL



Döllken hot melt adhesive



Döllken strip cutter



Döllken skirting scissors



Döllken mitre shears



Döllken Easy-Scooter



Döllken notching pliers



Döllken rubber hammer



Döllken joint filler



Döllken skirting board nails



ClipStar metal type G



UZIN adhesive strip



Screws



Mitre saw



Slotted screwdriver



Side cutter or pliers



Climate-resistant



Quick to install



Hard-wearing



Water-repellent



Slip-resistant at least class R10



Hot melt gun



Repair angle



Please note that the images and colours of the decors shown in this catalogue may not completely accurately reproduce the originals due to deviations of the printed colours.

Contents

Solidcore skirting Robust and suitable for professional installation	from page 8
LED and cable duct strips Perfect combination of outstanding appearance and functional qualities	from page 42
Plastic skirting boards Reliable fitting to various types of flooring	from page 50
Wall and special profiles Clean finish against walls, door frames and heater pipes	from page 68
Flexible skirtings Installed in no time for perfect transition between wall and floor	from page 84
Floor profiles The ideal solution for sites subject to extensive stresses	from page 96
Tools Perfectly designed to meet all current needs	from page 112
Kitchen profiles Clean finish between worktop and wall	from page 128
Other products Useful helpers and all-round aids for daily use	from page 135

Contact details for our customer services

Wholesalers and retailers:
+49 (711)3643 4170 0
info@doellken-profiles.com

DIY stores:
+49 2383 910 00 717
kundencenter@praktikus.de

Industrial sector:
+49 2383 910 00 717
info@doellken-profiles.com

Artisans and architects:
+49 (711)3643 4170 0
info@doellken-profiles.com

We are always there for you! If you have enquiries outside our normal office hours, you can always contact us by email. We will get back to you as soon as possible.





Solidcore skirtings

Excellent in terms of practical installation and ecological balance

All our solidcore skirtings are characterised by the following properties and advantages:

- High-quality cores made of certified conifer wood fibres
- With high performance polymer covering
- Very robust and durable
- Easy to install as all our solidcore skirtings can be mitred

Overview of our solidcore skirtings

(Wholesale | All sales outlets)

	Page
EP 60 flex life	11
S 60 flex life Top	12
S 60 flex life with short soft lip	14
Solidcore Skirting Board 60/80	15
S 100 life	16
KSO 6/8	17
Cubu flex life	24
Cubu life 60 without soft lips	25
Cubu flex life Decor	26
Cubu flex life Premium	28
Cubu flex life XL	29
Cubu flex life Urban Jungle	30
Cubu structured	32
Hamburger Style 80 slim	33
Hamburger Style	34
D 60 life Top I CV adhesive skirting 60	35
C 60 life Top	36
TS 60 life Top	38
TS 100 life	39
Cored carpet skirting 60	41



Nearly all our solidcore skirtings have been awarded the Blue Angel ecolabel (with the exception of Cubu Premium)



EP 60 flex life

Also available
in 80 mm
height
(Minimum purchase unit
from 1000 m)

Suitable for the following flooring types

- Solidcore skirting specifically for decorative floorings

Product information

- HDF core encased in a chlorine-free PP/TPE-based polyblend, with flexible soft lips top and bottom
- Decors match decorative flooring collections per consolidated lists (see current lists on our website)
- Profile ends can be readily formed from the profile itself with the Döllken skirting board punch without additional elements



PVC-FREE

www.blauer-engel.de/uz176



TCF
totally
chlorine-
free



Installation recommendations



Döllken
punch



Döllken hot melt
adhesive



Döllken
skirting scissors
(for EP 60 mm only)

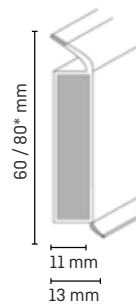

Scan here and get
tips for installation!



Wholesale

- 1 PU = 10 x 2.5 m
(EP 60 also available in small units for filling)

* Minimum purchase unit from 1000 m for 80 mm height

Colours

- Our range contains an extensive selection of different decors

(Other colours available on request)

For our complete
range of decors,
please see our
website.

S 60 flex life Top

Shorter lengths available on request!

Matches the following flooring types

- Solid core skirting matching all flooring types

Product information

- HDF core encased in a chlorine-free PP/TPE-based polyblend, with flexible soft lips top and bottom



www.blauer-engel.de/uz176



Installation recommendations



Döllken punch



Döllken hot melt adhesive



Döllken notching pliers



Döllken skirting scissors



UZIN adhesive strip

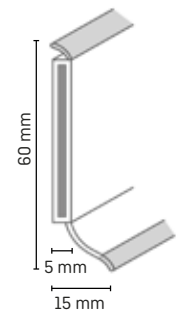

Wholesale

- 1 PU = 20 x 5.15 m
(also available as 20 x 2.57 m on request)

Accessories

- 1 PU = 10 units
- Available in the following colours:
1013 white, 1147 grey



End cap left/right



Connector

Contemporary new range:

- ✓ adapted to current flooring decors
- ✓ More extensive printing and new embossing techniques

New stock programme

38 new decors and two new colours

										
1408 white	1246 platinum silver	2491 white pine	2452 calistoga cream	2989 blond limed oak	2813 island oak honey	2619 ash blond 2022	vintage oak grey	2330 ash white	3606 natural summer oak	2032 twist
										
2511 bleached ash	2369 rustic board	3483 natural place	2646 natural maple	2412 tuscan walnut	2254 light classic oak	2388 victoria oak	2518 scandin. country plank	2487 wild oak	2639 scandinavian pine	2364 medium fruit tree
										
2425 alba oak cottage	2396 orient oak	2573 western oak	3101 grant oak brown	2493 classic oak	2324 rustic gold oak	3621 summer oak greige	2660 chene gris	2495 grey oak	2645 grey limed oak	2698 warm rustic pine
										
2447 calistoga grey	2574 country oak	2976 spirit oak silver	2402 honey oak	2567 summer oak	2449 aruba	3889 natural summer beech				

We have 22 popular colours and decors in stock

										
1005 white	1013 white	1145 white	1012 light grey	1147 grey	1209 anthracite	1144 black	1148 beige	1152 (M60) silver metallic	1168 (M60) alu metallic	1245 champagne
										
2780 boogie	2781 salsa	2782 quartet	2365 pale oak	2395 nut tree island	2570 native oak	2339 classic oak	2357 stained country plank	2485 smoked oak white	2572 fashion oak	2571 vintage desert

S 60 flex life with short soft lip



Matches the following flooring types

- Solid core skirting matching all flooring types

Product information

- HDF core encased in a chlorine-free PP/TPE polyblend, with flexible soft lips top and bottom

Installation recommendations



Döllken punch



Döllken hot melt adhesive



Döllken notching pliers



Döllken skirting scissors



UZIN adhesive strip

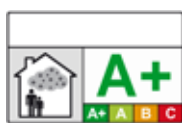
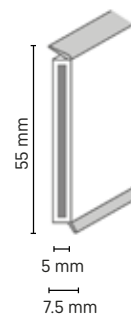

www.blauer-engel.de/uz176

Wholesale

- 1 sales unit = 20 x 5.15 m
(also available as 20 x 2.57 m on request)

Colours

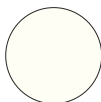

1013 white

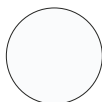

1408 white



1147 grey



1012 light grey



1209 anthracite



1144 black

Solidcore skirting 60/80

Additional colors
in 80 height
on request

Suitable for the following flooring types

- Solidcore skirting for all flooring types

Product information

- HDF core encased in a chlorine-free PP/TPE-based polyblend,
- with flexible soft lips at bottom

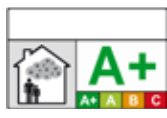

www.blauer-engel.de/luz176

Installation recommendations



Döllken punch



Döllken hot melt adhesive



Döllken notching pliers



Döllken skirting scissors

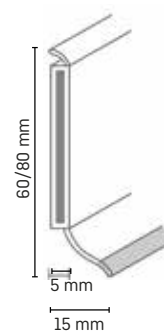

All sales outlets

- 1 PU = 20 x 2.55 m (60 mm height)
- 1 PU = 10 x 2.575 m (80 mm height)

Accessories

Available as:

- SS: 1 PU = 5 x 2 units
- LP: 1 sales unit = 1 x 50 units



Inner corner



Outer corner



End caps (left and right)

Colours in SS packs:

- oak
- rustic oak
- white
- silver-grey
- black

- maple
- beech
- beige
- dark beech
- dark grey

Colours in large packs:

- white
- dark grey
- pale beech

Solidcore skirting 60 colours

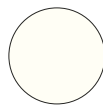

1013 white

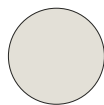

1132 white



1147 grey



1131 grey



1144 black



1230 white



1231 pale grey



1235 beige



1232 dark grey



3002 beech



3004 rufino oak



3005 beige oak



3006 maple london



3007 country maple



3008 maple

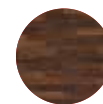

3012 walnut



3013 pale walnut



3014 natural oak



3018 pale beech



3019 beech



3020 oak



3021 pale aspen oak

Solidcore skirting 80 colours

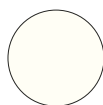

1013 white



1012 pale grey



1147 grey



0110 black

S 100 life

Shorter lengths available on request!

Suitable for the following flooring types

- Solidcore skirting for all flooring types

Product information

- HDF core encased in a chlorine-free PP/TPE-based polyblend, with flexible soft lips at bottom



www.blauer-engel.de/uz176



Installation recommendations



Döllken punch



Döllken hot melt adhesive



Döllken notching pliers



UZIN adhesive strip

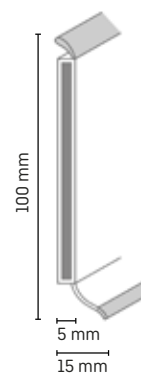

Wholesale

- 1 PU = 10 x 5.15 m

Colours

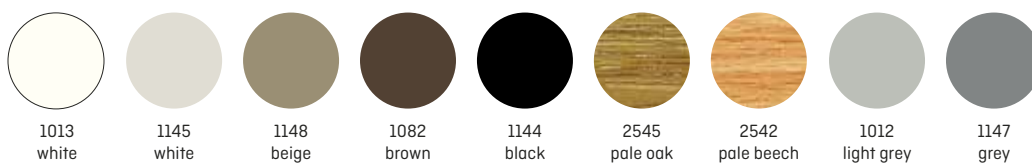

{Other colours available on request}



Scan now and view installation tips on our YouTube channel!

KSO 6/8



Suitable for the following flooring types

- Solidcore skirting for all flooring types

Product information

- HDF core encased in a chlorine-free PP/TPE-based polyblend,
- with flexible soft lip at bottom

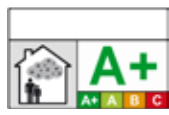

www.blauer-engel.de/uz176

Installation recommendations



Döllken punch



Döllken hot melt adhesive



Döllken notching pliers



Döllken skirting scissors

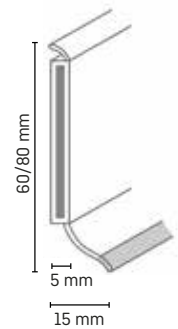

Wholesale

- 1 PU = 20 x 5.15 m

Accessories

- LP: 1 sales unit = 1 x 50 units



Inner corner



Outer corner



End caps (left and right)

Colours in large packs:
oak, white, grey, pale beech

Colours

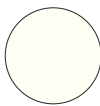

1013 white



1014 pale beige



1012 light grey



1082 brown



1147 grey



1144 black



1145 white



1148 beige



2772 andante beech



2542 pale beech



2543 beech



2545 pale oak



2548 pine

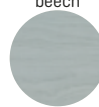

2549 grey wood



2551 white wood

All distributors

- 1 PU = 20 x 2.575 m

Accessories

- SS: 1 PU = 5 x 2 units



Inner corner



Outer corner



End caps (left and right)

Colours in SS packs:
oak
rustic oak
light grey
white
grey
black
maple
beech
beige oak
dark beech

Colours KSO 6

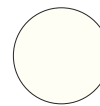

1013 white



2545 pale oak



1147 grey

Colours KSO 8

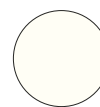

1013 white



1012 light grey



1147 grey



1144 black

Floor layer training at our Event Centre

By professionals for professionals

See our website for more information!

Register online now and take part in our next training course! Don't wait too long – there are only a limited number of places!



For a payment of just €119*, you'll experience two days of professional advice on how to lay skirting boards.

*Price is per person, plus VAT and covers the following: hotel accommodation, meals, supporting programme, voucher for tools (does not cover costs of travel to and from venue). In the case of events not requiring accommodation, the corresponding amount will be retained as a deposit and returned on course completion. Payments will not be reimbursed on failure to attend or cancellations within 4 weeks of the event date.

Our Event Centre is in an idyllic location near to the metropolitan Dortmund region.



Drei-Eichen-Weg 5
59069 Hamm



Our Event Centre in Hamm

Theory and practice:
Punching, use of adhesives and positioning of skirting – practical tutorials for all participants with valuable tips and advice from our installation specialists and presentation of our new products



Workshops/training courses

View behind the scenes:
Visit to Döllken Profiles skirting production site in Bönen; fascinating insights!



Production site visits

We will organise a suitable supporting programme (e.g. visit to the stadium of Borussia Dortmund) with meals and hotel accommodation. There will also be exclusive special features, such as advice on punching tool maintenance and vouchers or discount offers for Döllken tools.



Supporting programme and exclusive features

The diversity of the Cubu family



2 thicknesses

2 forms

4 heights

5 surface finishes

Many combination options:
the choice is yours

Just get in touch with
us to put together
your own Cubu
concept!



On request, all solidcore skirtings identified using this label in the catalogue can be supplied so that they can be combined with each other.

myCUBU

..... 11 and 16 mm wood core (with overlap 13 mm/18 mm)

..... Cubic form and Hamburger Style

..... 40, 60, 80, 100 mm

..... Unicoloured plastic surfacing, tactile plastic films,
chlorine-free plastic films, melamine films, real metal foils

The Cubu family

Advantages at a glance

- ✓ Can be mitred: Closed corners, no visible gaps between cut edges, no silicone or similar elements required
- ✓ Hard-wearing and resistant to impacts, soiling and moisture
- ✓ Easy to handle, rapid and uncomplicated installation
- ✓ Water-repellent plastic coating





www.blauer-engel.de/uz176

**PVC-
free**

**Made in
Germany**

Greenguard-certified, safe to use in sensitive environments, such as schools and health institutes.

Nearly all our solidcore skirtings* have been awarded the Blue Angel ecolabel: this means that the wood in the core has been obtained from sustainable, eco-friendly forestry and that the skirting is no risk to health as it is low-emission and contains no hazardous substances.

A healthy living environment: with our PVC-free Cubu skirting, you can be sure that your home will be free of any potential hazardous chemicals.



*With the exception of Cubu Premium



Suitable for the following flooring types

- Solidcore skirting for all flooring types

Product information

- HDF core encased in a chlorine-free PP/TPE-based polyblend, with flexible soft lips top and bottom
- Profile ends can be readily formed from the profile itself with the Döllken skirting board punch



www.blauer-engel.de/uz176

Installation recommendations



Döllken punch



Döllken hot melt adhesive



Döllken joint filler set



Döllken skirting scissors (for Cubu 60 mm only)

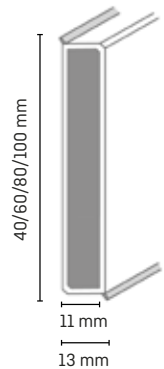

All distributors

- 1 PU = 10 x 2.5 m

Accessories

- 1 PU = 5 x 2 units



Corner pieces for inner and outer corners

Colours
1013 white
1063 silver

Scan now and view installation tips on our YouTube channel!



Colours

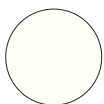

1013 white

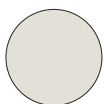

1132 white



1012 light grey



1209 anthracite



1245 champagne



1246 platinum silver



1144 black



1408 white

[Other colours available on request]

Four different heights – available colours:

Cubu flex life	40 mm	60 mm	80 mm	100 mm
1013 white	✓	✓	✓	✓
1132 white	✓	✓	✓	✓
1408 white	✓	✓	✓	-
1012 light grey	✓	✓	✓	✓
1209 anthracite	✓	✓	✓	✓
1245 champagne	✓	✓	✓	✓
1246 platinum silver	✓	✓	✓	-
1144 black	-	✓	✓	✓

Cubu life 60

NEW!

Without soft lips

Suitable for the following flooring types

- Solidcore skirting for all flooring types

Product information

- HDF core encased in a chlorine-free PP/TPE-based polyblend
- Solidcore skirting without soft lips; silicone can thus be used to individually improve transitions between skirting, floor and wall where there are major wall or floor irregularities
- Particularly suitable for renovation e.g. of older structures
- Proven advantages of the Cubu range: resistant to moisture, soiling and impacts
- Profile ends can be readily formed from the profile itself with the Döllken skirting board punch without additional elements

Installation recommendations



Döllken punch



Döllken hot melt adhesive



Döllken joint filler set



Döllken skirting scissors

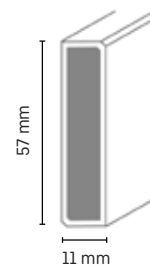

www.blauer-engel.de/uz176

All sales outlets

- 1 PU = 10 x 2.5 m

Colours

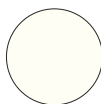

1013 white

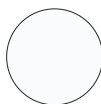

1408 white

Accessories

- 1 sales unit = 5 x 2 units



Corner pieces for inner and outer corners

Colours
1013 white

Cubu flex life Decor

New Decors



Suitable for the following flooring types

- Solid core skirting matching all flooring types

Product information

- HDF core encased in a chlorine-free PP/TPE-based polyblend
- With flexible soft lips top and bottom
- Design extends across whole skirting, soft lips are also printed
- Decors match many standard decorative floorings
- Profile ends can be readily formed from the profile itself with the Döllken skirting board punch without additional elements

Installation recommendations



Döllken punch



Döllken hot melt adhesive



Döllken skirting scissors

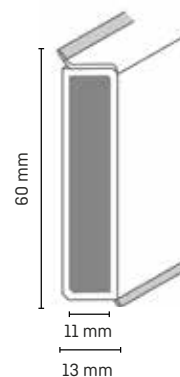

All sales outlets

- 1 PU = 10 x 2.5 m

Colours (more than 300 decors available)

1013 white	2033 calypso	2032 twist	2386 malua	2486 smoked oak	2572 fashion oak	2574 country oak	2580 grey cherry	2339 classic oak	2407 european oak	2022 vintage oak grey
2258 limed grey wood	2324 rustic gold oak	2332 waxed oak	2357 country plank	2365 pale oak	2369 rustic board	2428 alder	2370 silver oak	2373 silver slate	2375 vintage oak	2379 grey driftwood
2388 victoria oak	2402 honey oak	2424 natural oak	2445 monterey creme	2485 s. white oak	2487 wild oak	2491 white pine	2562 white pine	2570 native oak	2571 vintage desert	2603 classic oak
2615 grey sandstone	2629 alba oak snow	2661 chene naturel	1144 black							





























[Other colours available on request]

Discover the perfect harmony between skirting and your selected decorative flooring thanks to our fully printed decorative skirting. The printed soft lips will ensure an appropriate and uniform effect in your rooms.



www.blauer-engel.de/uz176



- | | | | | | | | | | | |
|---|---|---|--|--|---|---|--|---|--|--|
| 
2003
nordic ash | 
2004
dark classic oak | 
2015
filler eff light | 
2368
natural sandstone | 
2391
cambridge | 
2396
orient oak | 
2447
calistoga grey | 
2452
calistoga cream | 
2494
blond ash | 
2495
grey oak | 
2568
rustic oak |
| 
2698
rustic pine warm | 
2573
western oak | 
2589
royal oak | 
2719
iceland | 
2773
plankwood | 
2813
island oak honey | 
2986
white ash | 
3058
cc67523 | 
3096
lunar greige | 
3101
grant oak brown | 
3483
natural place |
| 
3594
sherman oak | 
3595
kentucky oak | 
3600
sebastian oak | 
3604
texas oak | 
3620
sheffield brown oak | 
3776
summer oak | | | | | |

More than 300 other decors in our range – available on request!

i

Cubu flex life Premium

Also available in
80 mm
height!*



Suitable for the following flooring types

- Solidcore skirting with real metal finish, thus eminently suitable as a design element with ambitious flooring schemes

Product information

- HDF core encased in a chlorine-free PP/TPE polyblend, with flexible soft lips top and bottom
- Finished with real metal foil
- The flexible wall and floor lips adapt to irregularities of each surface
- Profile ends and inner and outer corners can be readily formed from the profile itself with the Döllken skirting board punch without additional elements

Installation recommendations



Döllken punch



Döllken hot melt adhesive



Döllken skirting scissors (for Cubu 60 mm only)



Hot melt gun

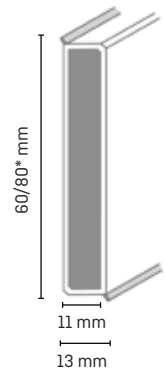

All sales outlets

- 1 PU = 10 x 2.5 m (60 height also available in small units for filling)

Colours



1190* stainless steel



1193 pale copper

*** The 80 height is only available for decor 1190 (stainless steel)!**

(Other colours available on request)

Tips from a professional: Heat the punched section using a hot melt gun and the special real metal film can then be shaped to form an outer corner.



Scan the QR code and view the video!



Suitable for the following flooring types

- Cubic skirting matching all flooring types, particularly suitable for the covering expansion joints when laminates are used

Product information

- HDF core encased in a chlorine-free PP/TPE-based polyblend, with flexible soft lips top and bottom
- Profile ends and inner and outer corners can be readily formed from the profile itself with the Döllken skirting board punch without additional elements
- More leeway when it comes covering expansion joints up to 18 mm, particularly when laminates are used

Installation recommendations



Döllken punch



Döllken clamping lever XL for punch



Döllken hot melt adhesive



Döllken joint filler set

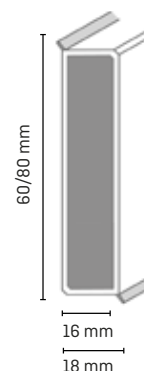

www.blauer-engel.de/uz176

All sales outlets

- 1 PU = 6 x 2.5 m (Cubu XL with 80 mm height)
- 1 PU = 8 x 2.5 m (Cubu XL with 60 mm height)

Accessories

- 1 PU = 5 x 2 units



Corner pieces for inner and outer corners

Colours 1013 white

Colours



1013 white

1132 white

1012 light grey

1408 white

[Other colours available on request]

Scan now: Tips for installation



Tips from a professional:

To ensure optimal fitting of a skirting board, it is advisable to use the support blocks supplied with the punch. You will find these on page 115.



Two different heights – available colours:

Cubu flex life XL	60 mm	80 mm
1013 white	✓	✓
1132 white	✓	✓
1012 light grey	–	✓
1408 white	✓	✓



OUR TREND COLORS FOR THE CUBU FLEX

All sales outlets

• 1 PU = 10 x 2,50 m

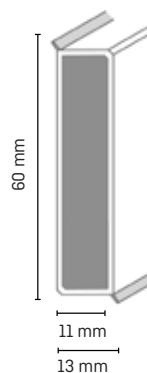

Colours

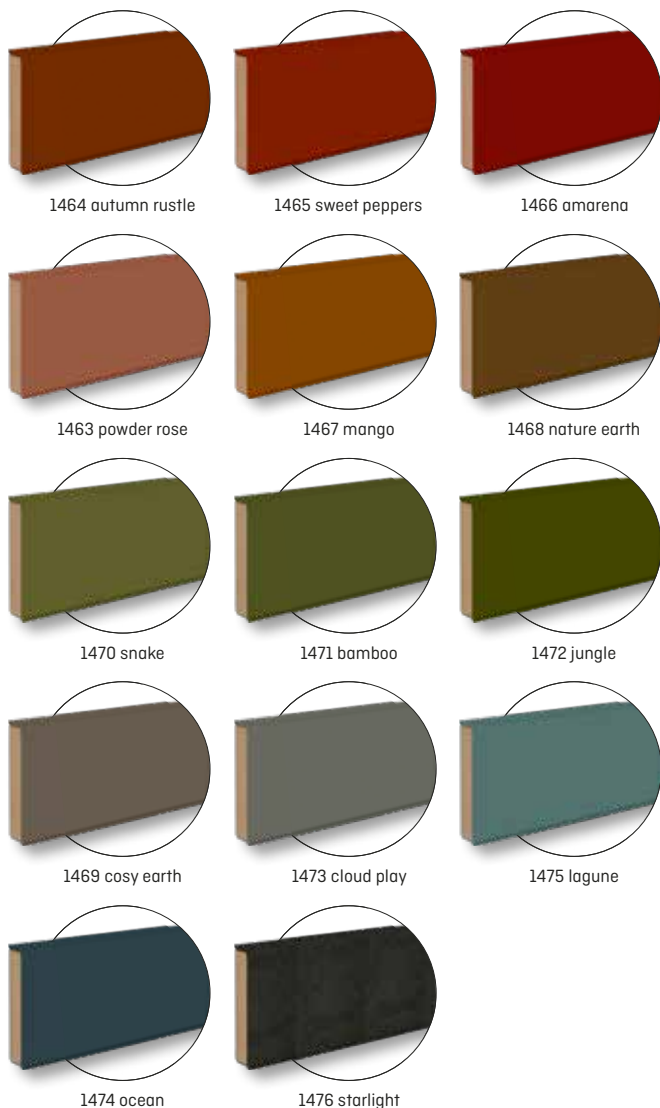

A new coat of paint for Cubu flex life

The new color variants, inspired by the vibrant nuances of urban nature, encourage creative interior design and give Cubu flex life skirting boards a modern, trendy touch. The palette ranges from earthy greens and reds to soft blues. In addition to these sophisticated colors, a powdery pink and light natural tones will also be on trend. These colors create a calm and harmonious atmosphere in any room. Overall, the trend colors consist of an exciting mix of strong, bright tones and soft, calming nuances.



www.blauer-engel.de/uz176

Order sample now





Cubu structured

NEW

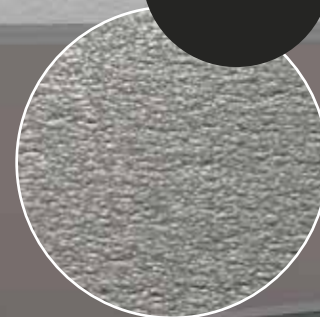

Suitable for the following flooring types

- Matches stone and concrete effects

Product information

- HDF core encased in a PP polyblend
- With flexible soft lips top and bottom
- Attractive, structured surface finish
- In eight different colours
- Available directly from stock
- Perfectly matches concrete and stone decors

Installation recommendations



Döllken
punch



Döllken
hot melt adhesive



Skirting scissors

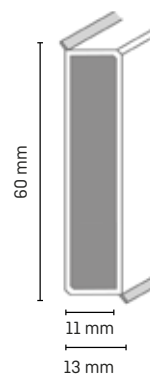

www.blauer-engel.de/uz176

All sales outlets

- 1 PU = 10 x 2.5 m

Colours

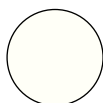

1408
traffic white



1329
pearl white



1416
beige grey



3103
grey beige



1139
stone grey



1448
grey aluminium



1367
slate grey



1468
nature earth

Hamburger Style 80 slim

NEW



Suitable for the following flooring types

- Classic style solidcore skirting for wood and laminate floorings

Product information

- 11 mm body thickness
- with flexible soft lips
- 13 mm overhang
- Flexible – easier installation on uneven walls
- Fast installation with the Döllken notch punch
- No additional XL clamping lever required

Installation recommendations



Döllken punch



Döllken joint filler



Döllken hot melt adhesive

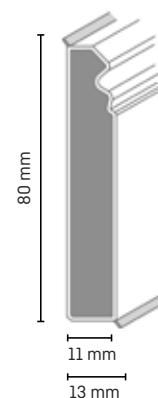

www.blauer-engel.de/uz176

All sales outlets

- 1 PU = 10 x 2.5 m

Tips from a professional:

To ensure optimal fitting of a skirting board, it is advisable to use the support blocks supplied with the punch. You will find these on page 115.



Colours

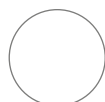

1013 white



1144 black

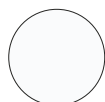

1408 white



1328 white

[Other colours available on request]

Hamburger Style



Suitable for the following flooring types

- Classic style solidcore skirting for wood and laminate floorings

Product information

- HDF core encased in a chlorine-free PP/TPE-based polyblend, with flexible soft lips top and bottom
- Profile ends and inner and outer corners can be readily formed from the profile itself with the Döllken skirting board punch without additional elements
- Durable and resistant to climatic changes
- Classic, timeless design for universal use

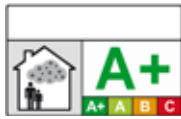

www.blauer-engel.de/uz176

Installation recommendations



Döllken punch



Döllken clamping lever XL for punch



Döllken hot melt adhesive



Döllken joint fill

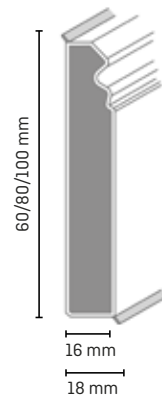

All sales outlets

- 1 PU = 8 x 2.5 m (Hamburger Style with 60 mm height)
- 1 PU = 6 x 2.5 m (Hamburger Style with 80 mm height)
- 1 PU = 7 x 2.5 m (Hamburger Style with 100 mm height)

Tips from a professional:

To ensure optimal fitting of a skirting board, it is advisable to use the support blocks supplied with the punch. You will find these on page 115.



Colours

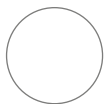

1013 white



1144 black



1408 white

(Other colours available on request)

Three different heights – available colours:

Hamburger Style	60 mm	80 mm	100 mm
1013 white	✓	✓	✓
1408 white	✓	✓	–
1144 black	✓	✓	–

D 60 life Top I CV glue-in infill 60

Only available in 5.15 m!



i
Now also available without sealing lip!

Suitable for the following flooring types

- Solidcore skirting designed for glueing in infills of floor covering

Product information

- HDF core, encased in chlorine-free PP/TPE-based polyblend and with a flexible floor lip
- For the infill of floor covering strips, suitable for flooring thicknesses of 4.5 mm
- The decorative covering strips are also punchable using the press-on inserts for punch 2001

Installation recommendations



Döllken punch



Döllken hot melt adhesive



Döllken skirting scissors



Döllken Strip cutter



UZIN adhesive strip



Döllken notching pliers

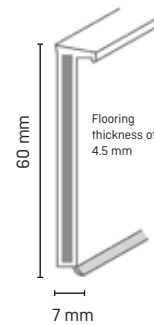

D 60

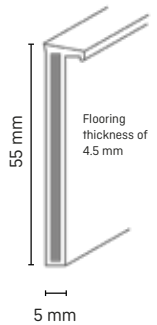

D 60 (without sealing lip)

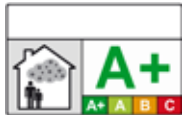

www.blauer-engel.de/uz176

Wholesale

- 1 PU = 20 x 5.15 m

Accessories

End caps:

- 1 PU = 10 units



End cap left/right

Available colours
1013 white



Press-on inserts

Press-on inserts:

- 1 PU = 1 set (2 units)

Tips from a professional:
Decorative flooring can also be punched with the press-on inserts for punch 2001 and can be cut with the flexible strip cutter.

Colours of D60



[Other colours available on request]

Colours (D60 without sealing lip)



C 60 life Top

Also available with
100 mm height!
(On request)



Suitable for the following flooring types

- Solidcore skirting designed for glueing in infills of floor covering

Product information

- HDF core, encased in chlorine-free PP/TPE-based polyblend and with a flexible floor lip
- For glueing in strips of the floor covering
- Suitable for flooring thickness of 4.5 mm
- The decorative covering strips are also punchable using the press-on inserts for punch 2001

Installation recommendations



Döllken punch



Döllken hot melt adhesive



Döllken skirting scissors



Döllken Strip cutter



UZIN UZIN



Döllken notching pliers

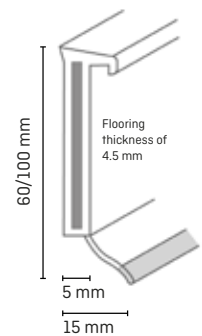

www.blauer-engel.de/uz176

Wholesale

- 1 PU = 20 x 5.15 m

Accessories



Press-on inserts

Press-on inserts:
1 PU = 1 set (2 units)

Colours

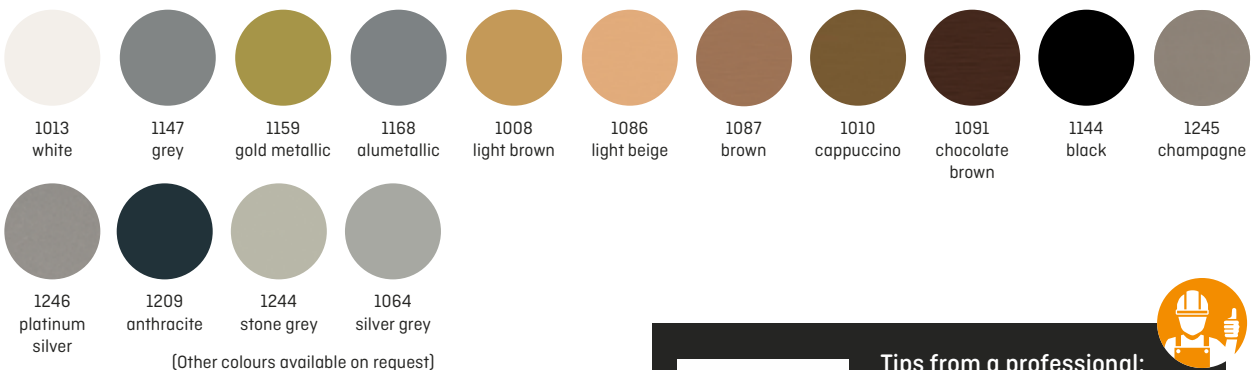

Tips from a professional:

Decorative flooring can also be punched with the inserts for punch 2001 and can be cut with the flexible strip cutter.



Let's see your skirting boards

You've just installed Döllken skirting that has produced a particularly pleasing effect? Then send us your photos or videos of your work!

Send a message to one of our social media sites or send an email to: marketing@doellken-profiles.com!

 [@doellkenprofiles_de](https://www.instagram.com/doellkenprofiles_de)

 [facebook.com/doellkenprofiles](https://www.facebook.com/doellkenprofiles)

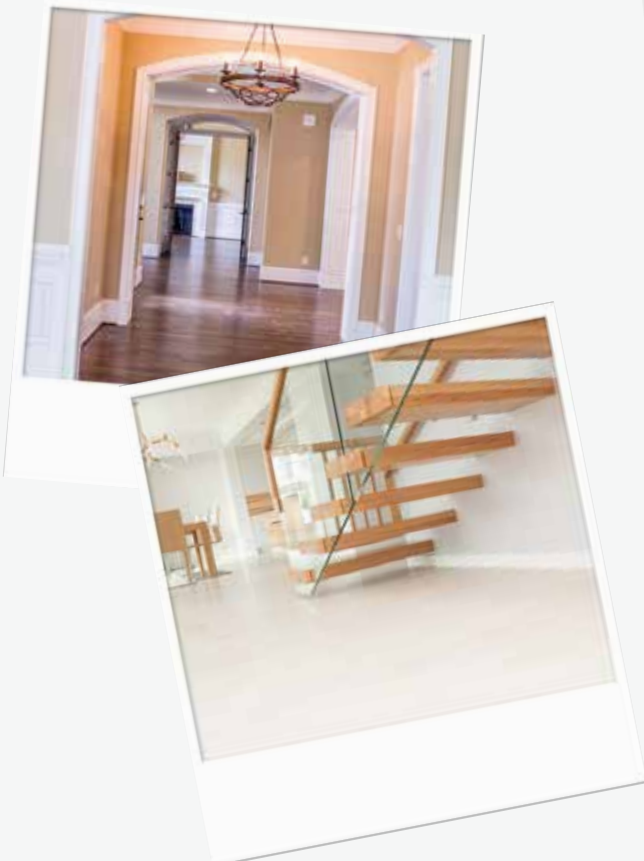

TS 60 life Top

Only available in 5.15 m!

Suitable for the following flooring types

- Solidcore skirting board for carpet flooring

Product information

- HDF core, encased with chlorine-free PP/TPE-based polyblend and with cable duct
 - For the infill of carpet strips
 - For carpets with PVC backing containing plasticiser; also available on request without adhesive strips
- Request details of minimum sale unit!

Installation recommendations



Döllken punch



Döllken hot melt adhesive



Döllken notching pliers



UZIN adhesive strip



Döllken skirting scissors



Döllken mitre shears

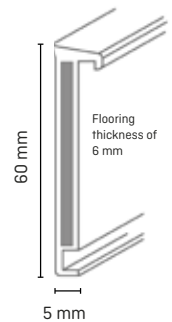

www.blauer-engel.de/uz176

Wholesale

- 1 PU = 20 x 5.15 m

Accessories

End caps:

- 1 PU = 10 units



Colours
1013 white

End cap
left/right

Tips from a professional:

See the installation instructions and videos on our website www.doellken-profiles.com, in the Döllken app or on YouTube.



Colours



1013
white



1145
white



1012
pale grey



1152
silver metallic



1147
grey



1082
brown



1144
black



NEW

1246
platinum
silver



NEW

1245
champagne



NEW

1209
anthracite

[Other colours available on request]

TS 100 life

Only available
in
5.15 m!

Suitable for the following flooring types

- Solidcore skirting board for carpet flooring

Product information

- HDF core, encased with chlorine-free PP/TPE-based polyblend and with cable duct
- For adhesion of carpet strips



www.blauer-engel.de/uz176

Installation recommendations



Döllken
punch



Döllken
hot melt adhesive



UZIN
adhesive strips

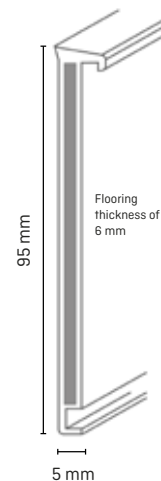

Wholesale

- 1 PU = 10 x 5.15 m

Tips from a professional:

See the installation instructions and videos on our website www.doellken-profiles.com, in the Döllken app or on YouTube.



Colours



1013
white



1147
grey

(Other colours available on request)



Solidcore carpet skirting 60



Suitable for the following flooring types

- Solidcore skirting board for carpet flooring

Product information

- HDF core, encased with chlorine-free PP/TPE-based polyblend and with cable duct
- For the infill of carpet strips
- Protects carpet edges against fraying



www.blauer-engel.de/uz176

Installation recommendations



Döllken punch



Döllken hot melt adhesive



Döllken skirting scissors



Döllken mitre shears

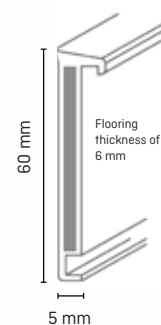

All sales outlets

- 1 PU = 20 x 2.55 m

Colours



1238 white



1241 pale grey



1242 dark grey



1243 black



3023 beech

(Other colours available on request)

Tips from a professional:

See the installation instructions and videos on our website www.doellken-profiles.com or on YouTube.

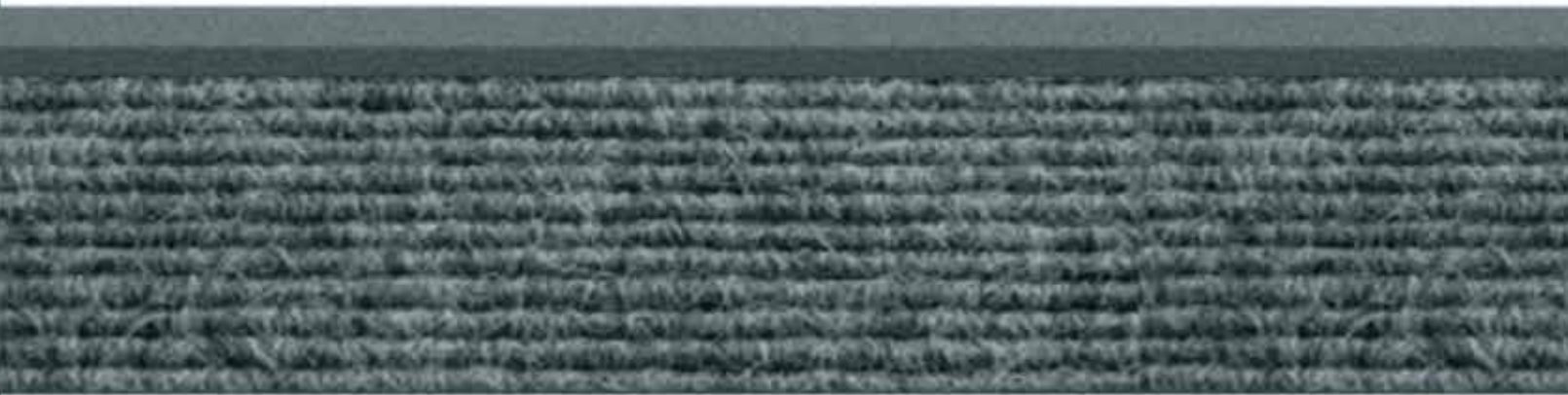



LED and cable duct skirtings

Perfect combination of attractive appearance and functional features

Our LED and cable duct skirtings have the following advantages:

- Unusually attractive
- Function features include practical cable ducts, removable and interchangeable decorative profiles
- Invisible fastening systems
- New tactile surface finishes for more decorative effects

Overview of our LED and cable duct skirtings

(Wholesale | All sales outlets)

	Page
Cubica Light System 80	45
System MD 63 / MD 63 rear-ventilated	46
System SL 48	47
SLK 50 Plastic skirting Classic 50	48
SLK 60 "Q" Plastic skirting Cubica 60 sk.....	49

Cubica Light System

A solution for professionals
that is child's play to install

2 Light system variants + 4 Decorative options = Perfectly designed light effect

Whether as a light accent for a comfortable atmosphere in your own four walls or as a security solution for hotels, ships or healthcare facilities – the Cubica Light System is the highest quality and most flexible lighting solution on the market.



Can be installed quickly and without prior knowledge with the starter kits



Plug & play
Put together and light on!



In addition to our standard package we can also produce tailor-made solutions for you!

- High-quality LED strip with uniform light distribution without visible light points
- Individually shortenable every 5 cm to the desired length
- Easy assembly without additional tools and prior knowledge
- Use as cable duct skirting or as combined light and cable duct skirting
- Prefabricated starter packages with all necessary components or individual tailor-made adaptation possible (check production of all required lengths and components using our product configurator)

Skirting



LED-Strip



Just go for it and configure



Cubica Light System 80

NEW



Cut cables in seconds with the new notching pliers (p. 121)!



For more information and tips on installation, go to:
www.licht-sockelleiste.de

Suitable for the following flooring types

- Combined light/cable duct skirting suitable for all flooring types

Cubica light system product information

- Two-part strip: base and cover profile* made of PVC-based polyblend, with flexible soft lips at the top and bottom (cover profile can be clicked on)
- Matching accessory components available
- High-quality LED strip easy to stick in (self-adhesive, can be shortened every 5 cm, uniform light effect, included in the separate starter kit)
- Can be combined with the Cubu flex life XL 80 (same decors and geometry)

Also available:

- Starter kit: Suitable for 5 m LED strip, (A) extension cable, (B) connector (LED strip to cable), (C) connector (LED strip to LED strip), (D) LED connection cable, (E) Y distribution cable, (F) power supply (transformer for 230 V socket), (G) LED strip

*Base profile, cover profile and starter package must be ordered

Installation recommendations



Mitre saw



Skirting scissors



screws



Döllen hot melt system



Slotted screwdriver



Side cutter or pliers

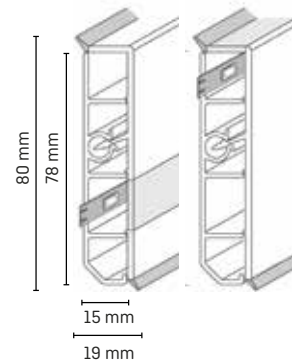

LED strip below (light down) or LED strip on top (light up) available

Starter kit components



All sales outlets

- 1 PU = 10 x 2.5 m (base profile)
(also available in small units for filling)
- 1 PU = 10 x 2.5 m
(also available in small units for filling)

Available in three variants:



No light (no light cable duct skirting)



Light down (light below)



Light up (light on top)

Accessories

- 1 PU = 5 x 1 unit (inner and outer corners, connectors)
- 1 PU = 5 x 2 units (end caps)



Inner corner



Outer corner



Connector



End caps (left and right)

Colours

1207 white
1160 aluminium
1245 champagne
1209 anthracite

Colours



1207 white



1160 aluminium



1245 champagne



1209 anthracite

(Other colours available on request)

System MD 63 / MD 63 rear-ventilated



Suitable for the following flooring types

- System skirting specially for laminate, hard and flexible floorings

Product information

- Profile 63 mm high – especially for renovations
- Consisting of decorative profile MD 63 and base profile GP 20, chlorine-free PS- or PP-based polyblend, with large cable duct
- Clean finish against floors and walls thanks to flexible soft lips top and bottom



Installation recommendations



Döllken hot melt



UZIN adhesive strip



Döllken skirting scissors



Döllken notching pliers

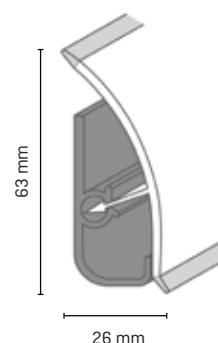

- The base profile must be separately ordered

All sales outlets

- 1 PU = 20 x 2.50 m (also available in small units for filling)

Accessories

1 PU = 10 units (also available in SS packs on request)



Colours
natural beech
oak light
alumetallic
white
light grey
pale acacia
concise oak
white oak (not for SS)
old ash
racine
tibidabo

GP 20

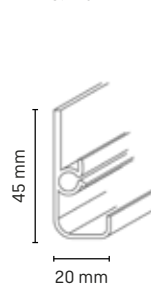

Base profile GP 20
1 PU = 20 x 2.50 m

*DP 63 (rear-ventilated)

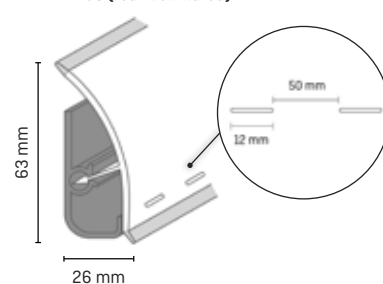

Colours (decorative profile)



MD 63 rear-ventilated
in 1129 white only

System SL 48

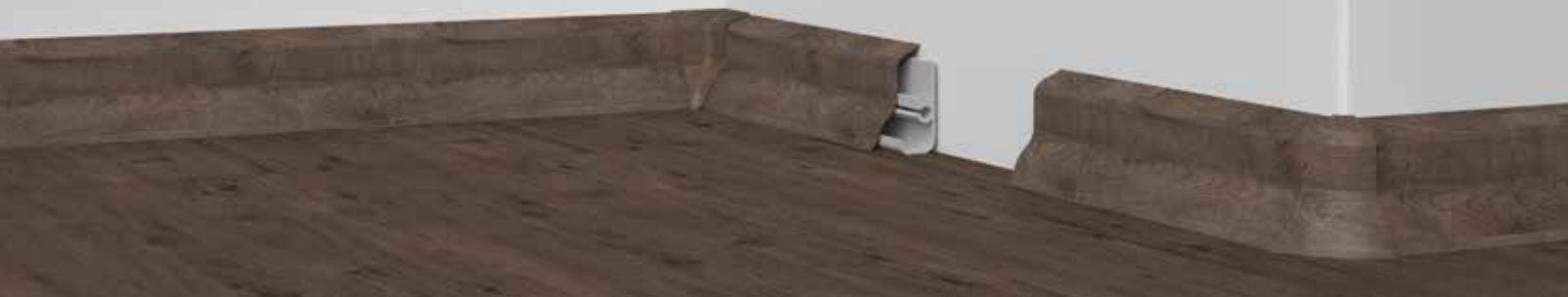

Suitable for the following flooring types

- System skirting specially for laminate, hard and elastic floorings

Product information

- Consisting of decorative profile DP 48 and base profile GP 20, chlorine-free PS- or PP-based polyblend, with large cable duct
- Clean finish against floors and walls thanks to flexible soft lips top and bottom



Installation recommendations



Döllken hot melt



UZIN adhesive strip



Döllken skirting scissors



Döllken notching pliers

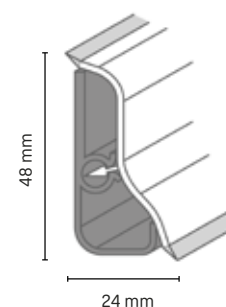

- The base profile must be separately ordered

All sales outlets

- 1 PU = 20 x 2.50 m (also available in small units for filling)

Accessories

1 PU = 10 units (also available in SS packs on request)



Inner corner 90° SS = 5 x 4 units



Outer corner 90° SS = 5 x 2 units



End caps left and right SS = 5 x 1 pair



Connector with cable outlet SB = 5 x 4 units

Colours
maple
pale beech
dark beech
alumetallic
oak
grey oak

white
nut tree
clooney
ligna
racine
rachel

tibidabo
grey
dark apple tree
striped pine



Inner corner 135° SS = 5 x 4 units



Outer corner 135° SS = 5 x 2 units

Colours
(135° corners)
white
alumetallic



Base profile GP 20
1 PU = 20 x 2.50 m

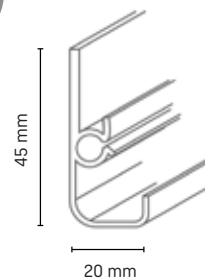

Colours (decorative profile)



1129 white



1128 light grey



1436 alumetallic



2476 pale beech



2477 dark beech



2478 oak



2479 maple



2532 grey oak



2533 striped pine



2534 dark apple tree



2947 ligna



2941 racine



2936 tibidabo

(Other colours available on request)

SLK 50 | Plastic skirting Classic 50



Suitable for the following flooring types

- System skirting for all flooring types, particularly for laminate floorings

Product information

- Large selection of modern decors
- Simple installation by screwing or gluing
- Cable duct for hidden laying of media cables
- Soft lips for a clean finish against floor and wall
- Accessories to match decor



Installation recommendations



Döllken hot melt



Döllken skirting scissors

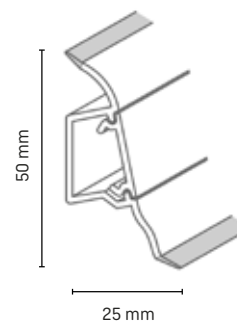

All sales outlets

- 1 PU = 20 x 2.50 m
- 1 PU = 10 x 2.50 m

Accessories



Inner corner 90°
SS = 5 x 2 units



Outer corner 90°
SS = 5 x 1 units



End caps
left and right
SS = 5 x 2 units



Connector
SS = 5 x 2 units

Colours (1 PU = 20 x 2.50 m)



2150
sardinian
oak



2140
oak



1436
alu metallic



2092
dark acacia



2087
yellow beech

Colours (1 PU = 10 x 2,50 m)



1137
white



2080
vosges oak



2099
rustic
oak



2135
tamari



2137
essencial



2085
dark beech

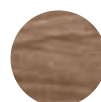

2143
flavour

SLK 60 "Q" | Cable duct skirting Cubica 60 sk



Also available without self-adhesive strip on request!

Suitable for the following flooring types

- System skirting for all flooring types, particularly for laminate floorings

Product information

- Large selection of modern decors
- **Self adhesive** – simple installation
- Cable duct for invisible installation of media cables
- Soft lips for a clean finish against floor and wall
- Accessories to match decor
- Also available on request without adhesive strip – for installation with screws or adhesive



Installation recommendations



Döllken hot melt



Döllken skirting scissors

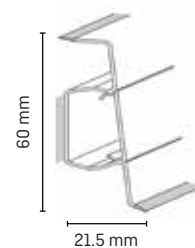

Tips from a professional:

With the cable duct in decor "0000 milky", SLK 60 can also be used as light skirting. Simply insert an LED strip into the cable duct and you'll have the perfect lighting atmosphere.



All sales outlets

- 1 PU = 10 x 2.50 m

Accessories



Inner corner 90°
SS = 5 x 2 units



Outer corner 90°
SS = 5 x 1 units



End caps
left and right
SS = 5 x 2 units



Connector
SS = 5 x 2 units

Colours



1137
white



3040
wasabi oak



3047
natural oak



3048
silver oak



3160
beech



3166
pine



3168
driftwood
oakgrey



3161
sea pine

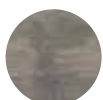

3167
rustic
hemlock



3170
royal elm



Exclusive colour for cable duct cover



0000*
milky

There are matching decor-identical cable duct covers in the above colours.

- 1 PU = 20 x 2.50 m* [*Only for decor 0000 milky]

Plastic skirtings



A real highlight for all floorings

The plastic skirtings by Döllken Profiles are unique and have the following characteristics and advantages:

- Impressive effects on all types of flooring
- Available in different heights and top forms
- Moisture-resistant
- Provides for attractive finishes against various carpeting, flexible and hard flooring
- All components of skirtings are REACH-compliant
- Available in many decorative, high-quality finishes

Overview of our plastic skirtings

(Wholesale | All sales outlets)

	Page
HSL 6	52
HSL 8 & HSL 10	54
USL 60 Hard foam skirting Modern 60	55
USL 60 Cubica Hard foam skirting Cubica 60	56
USL 60 Cubica sk	57
USL 60 Clip Hard foam skirting Modern 60 Clip	58
Hard foam skirting Modern 60 Clip sk	59
USL 50 Foam skirting Classic 50	60
TL 51 Carpet skirting 50	61
RL 10	62
TLE 55	63
TLE 55 sk	63
TL 55 Carpet glue-in skirting 55	64
Tile renovation skirting	65
Hard foam edging	66
Decorative skirting DSL 60	67

HSL 6



Suitable for the following flooring types

- Universal skirting for all flooring types

Product information

- PVC-based polyblend (all components REACH-compliant)
- More flexibility thanks to a robust surface and improved soft lips that adapt to floor and wall irregularities and provide for a clean finish
- Moisture-resistant



Installation recommendations



Döllken punch



Döllken hot melt



Döllken notching pliers



Döllken skirting scissors



UZIN adhesive strip

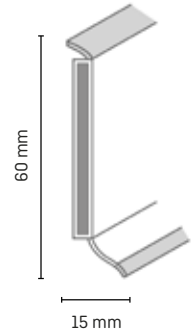

Wholesale

- 1 PU = 25 x 4 m

Colours

2620 maple	2202 silver-grey	2171 oak	2273 beech	2216 ramin	2217 rustic oak	1088 light beige	2221 antique fir	2224 bomanga	2223 paduck	2222 ikarus
2220 sea oak	2225 mahogany	1111 dark blue	2219 chestnut	0110 Black	1051 grey	2218 choco wenge	1074 silver	1109 green-blue	1135 white	1245 champagne
2365 pale oak	2336 shoreline beech	2587 traditional oak	2572 fashion oak	2033 calypso	2660 chene gris	2428 alder	2032 twist	2386 malua	2574 country oak	2580 grey cherry
2357 stained country plank	2395 moon island	1408 white	1049 dark grey	1148 beige	1393 light beige	3889 natural summer beech	2022 vintage oak	2402 honey oak	2445 monterey creme	2562 white pine
2424 natural oak										

[Other colours available on request]

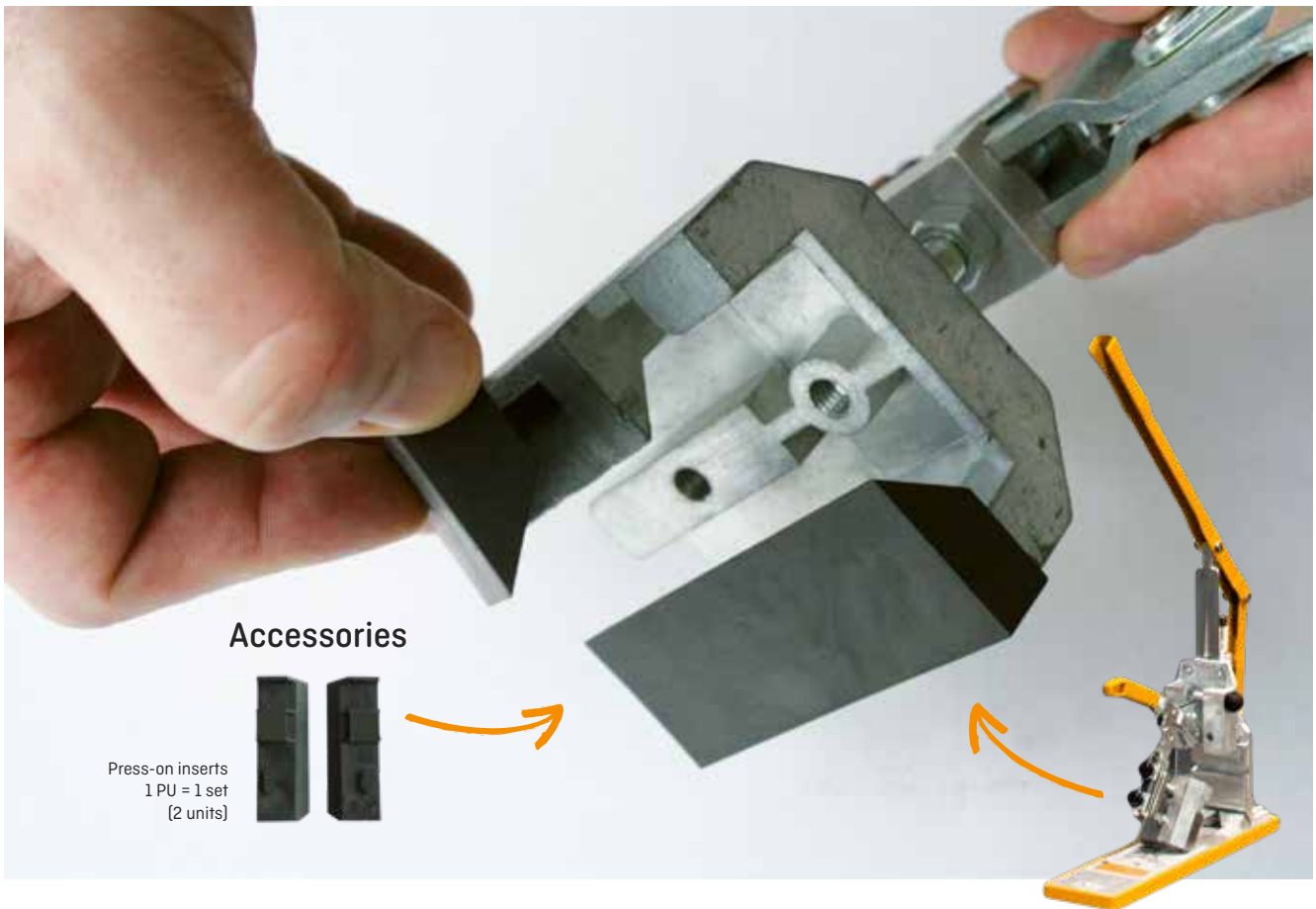

All sales outlets

• 1 PU = 20 x 2.5 m

Colours

1088 light beige	2202 silver-grey	2171 oak	2219 chestnut	2220 sea oak	2221 antique fir	2224 bomanga	1048 dark brown	1049 dark grey	0110 Black	1051 grey
1074 silver	1135 white	2272 Beech	2218 choco wenge	1245 champagne	1408 white	2033 calypso	2660 chene gris	2032 twist	2574 country oak	2580 grey cherry
1148 beige	3889 natural summer beech	2022 vintage oak	2402 honey oak	2445 monterey creme	2562 white pine	2424 natural oak				

HSL 8 and HSL 10



Suitable for the following flooring types

- Universal skirting for all flooring types

Product information

- PVC-based polyblend (all components REACH-compliant)
- More flexibility thanks to robust surface and improved soft lips that adapt to floor and wall irregularities and provide for a clean finish
- Moisture-resistant



Installation recommendations



Döllken punch



Döllken hot melt



Döllken skirting scissors



Döllken notching pliers

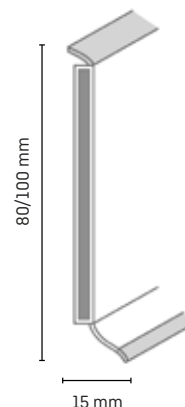

All sales outlets

- 1 PU = 20 x 2.5 m

Accessories



Press-on inserts
1 PU = 1 set
(2 units)

Colours HSL 8



1088
light beige



1048
dark brown



1049
dark grey



1135
white



0110
Black



1051
grey

Colours HSL 10



1088
light beige



1049
dark grey



1135
white



0110
Black



1051
grey

USL 60 | Hard foam skirting Modern 60



Suitable for the following flooring types

- Particularly suitable for laminate floorings

Product information

- PVC-based polyblend (all components REACH-compliant)
- Moisture-resistant
- Fast and simple installation by nailing or gluing (no clips required)



Installation recommendations

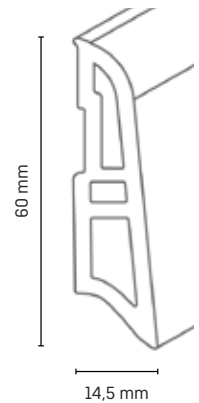
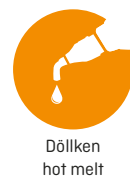

Wholesale

- 1 PU = 10 x 4 m

Accessories
1 PU = 10 units

- Colours***
- uni white
 - uni beech
 - uni grey
 - uni silver
 - uni oak
 - uni rustic
 - uni antique
 - uni black

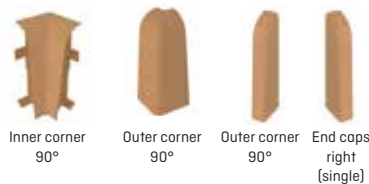

Colours



(Other colours available on request)

* The colours of accessories are not identical with those of skirtings. For a consistent appearance, mitre with saw as appropriate.

You will find matching component decors on our website at www.doellken-profiles.com (Products > Plastic skirtings > USL 60 > Accessories)

All sales outlets

- 1 PU = 10 x 2.50 m

Accessories
1 PU = 5 units

- Colours***
- uni white
 - uni beech
 - uni grey
 - uni silver
 - uni oak
 - uni rustic
 - uni antic
 - uni black

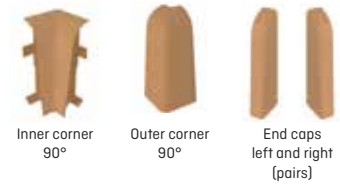

Colours (other colours available on request)



USL 60 Cubica | Hard foam skirting Cubica 60



Suitable for the following flooring types

- Decorative flooring, vinyl, LVT
- Laminate
- PVC, linoleum

Product information

- PVC-based polyblend
(all components REACH-compliant)
- Moisture-resistant
- Numerous decorative films available



Installation recommendations



ClipStar
metal type G



Döllken
skirting scissors



Mitre saw

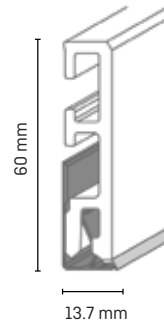

All sales outlets

- 1 PU = 10 x 2.5 m

Accessories

- End caps
SS: 5 x 2 units

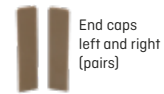

End caps
left and right
(pairs)

- ClipStar metal type G
1 PU = 10 bags à 50 units
Or 1 PU = 10 bags à 20 units

Colours (SS)

white
silk grey
ivory
pale brown
grey
ochre brown
oak
uni silver

Colours USL 60 Cubica



3186
concrete
grey



3187
anthracite
concrete



3188
pale
oak



3189
grey
oak



3190
grey vintage
oak



3191
grey oak



3192
amber oak



3193
natural pear tree



3194
natural oak



3195
creme oak



3196
natural nut
tree



USL 60 Cubica can be combined with the decorative surfaces of USL 60 Cubica SK (p. 57) and Cubu Premium.

Minimum purchase quantity: 1000 m.

USL 60 Cubica sk

Self-adhesive



Suitable for the following flooring types

- Decorative flooring, vinyl, LVT
- Laminate
- PVC, linoleum

Product information

- PVC-based polyblend (all components REACH-compliant)
- Moisture-resistant
- Numerous decorative films available
- **Self-adhesive variant** (two applied adhesive strips on the profile reverse)



Installation recommendations



Mitre saw

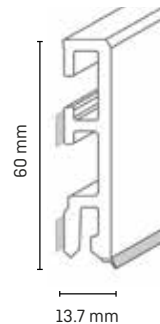

All sales outlets

- 1 PU = 10 x 2.5 m

Colours USL 60 Cubica self-adhesive variant

3163 ancona	2348 modern oak	3184 padova oak	3143 fa tren oak	3172 vers oak	3158 bari stone
3144 country pine	3147 white oak	3164 milano	3148 canadian pine	3149 niagara hemlock	3150 florida pine
3151 colorado oak	2832 pale slate	3346 natural oak	3347 white oak	3348 grey oak	3289 midland oak white
3290 brio oak	3209 dark grey oak	3291 sand oak	3292 midland oak	3293 midland oak brown	3231 skagen oak
3294 moorland oak	3295 country oak	3221 oak grey	3077 needlewood	3159 spa tu grit	3188 oak
3219 oak	2348 modern oak	1328 white			

(Other colours available on request)

Accessories

SS: 5 x 2 unit



End caps left and right (pairs)

- Colours (SS)
- white
 - silk grey
 - ivory
 - pale brown
 - grey
 - ochre brown
 - oak light
 - silver
 - oak

Matching accessory colours

Skirting decor	End caps
ancona	3163 silk grey
padova oak	3184 oak
fa.tren oak	3143 oak
vers. oak	3172 pale oak
bari stone	3158 grey
country pine	3144 oak
white oak	3147 silk grey
milano	3164 silver
canadian pine	3148 ivory
niagara hemlock	3149 oak
florida pine	3150 oak
colorado oak	3151 oak
pale slate	2832 silver
oak natural	3346 oak
white oak	3348 silk grey
grey oak	3347 silk grey
midland oak white	3289 ivory
brio oak	3290 silver
dark grey oak	3209 silver
sand oak	3291 silk grey
midland oak	3292 silver
midland oak brown	3293 oak
skagen oak	3231 oak
white	1328 white
moorland oak	3294 oak
country oak	3295 grey
grey oak	3221 silk grey
needlewood	3077 silk grey
spa tu grit	3159 oak
bright oak	3188 oak
oak	3219 oak
modern oak	2348 bright oak

USL 60 Clip | Hard foam skirting Modern 60 Clip



Suitable for the following flooring types

- Particularly suitable for laminate floorings

Product information

- PVC-based polyblend (all components REACH-compliant)
- Moisture-resistant
- New integrated soft lip guarantees clean finishes
- Available in many decorative, high quality finishes



Installation recommendations



ClipStar metal type G



Döllken hot melt



Döllken skirting scissors



Mitre saw

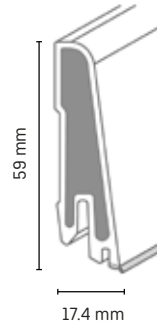

All sales outlets

- 1 PU = 10 x 2.5 m

Accessories

- Elements
- LP: 1 PU = 10 units
- SS: 5 units



Inner corner 90°



Outer corner 90°



End caps left and right (pairs)

You will find matching component decors on our website at www.doellken-profiles.com
 (Products > Plastic skirtings > USL 60 Clip > Accessories)

- ClipStar metal type G
- 1 PU = 10 bags à 50 units
- Or 1 PU = 10 bags à 20 units

Colours

1137 white	2679 roma	2680 assisi	2681 genova	2688 sicily	2682 corsica	2683 mykonos	2684 malta	2685 golden oak white	2686 golden oak honey	2687 natural gold oak
2675 smoky oak pewter	2709 smoky oak gold	2734 smoky oak grey	2654 zermatt oak	2647 feldis oak	2433 kiental oak	2677 valles oak	2676 engelbert oak	2678 champery oak	2592 brown oak	2318 morgan pine
2655 torgon oak	2348 modern oak	2166 colorado oak	2643 steamed beech	2073 nut tree	2224 bomanga	2754 buende	2753 binz	2752 borna	2750 bebra	2755 pale weser
0110 black	2964 natural beech	2552 grey oak	2644 canadian maple	2169 oak	2742 colombia pine	2775 italia oak	3479 oslo oak	3481 riga oak	3480 paris oak	

Colours (LP)
 pale oak
 oak
 uni silver
 white
 champagne

Colours (SS)
 slate grey
 beige
 brown
 ochre brown
 silk grey
 pale brown
 ivory
 uni silver
 white oak
 pale oak
 grey

(Other colours available on request)

Hard foam skirting Modern 60 Clip sk



Suitable for the following flooring types

- Particularly suitable for laminate floorings

Product information

- PVC-based polyblend (all components REACH-compliant)
- Moisture-resistant
- New soft lip guarantees clean finishes
- Available in many decorative, high quality finishes
- **Self-adhesive variant** (applied foam adhesive strip (thickness: 2 mm) on profile reverse)



Installation recommendations



Döllken skirting scissors



Mitre saw

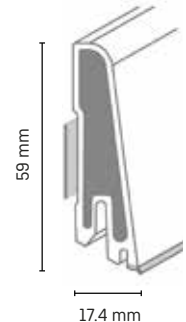

All sales outlets

- 1 PU = 10 x 2.5 m

Accessories

- Elements
- LP: 1 PU = 10 units
- SS: 5 units



Inner corner 90°



Outer corner 90°



End caps left and right (pairs)

- Colours (LP)**
- uni pale oak
 - uni oak
 - uni silver
 - uni white
 - uni champagne

- Colours (SS)**
- | | | |
|-------------|------------|----------------|
| slate grey | silk grey | white |
| beige | pale brown | oak |
| brown | ivory | oak light grey |
| ochre brown | uni silver | grey |

- ClipStar metal type G
- 1 PU = 10 bags à 50 units
- Or 1 PU = 10 bags à 20 units

Colours



3161 seapine



3169 grizzly pine



3167 rustic hemlock



3163 ancona



2348 modern oak



3184 padova oak



3164 milano



2832 pale slate



3165 grey oak



3172 vers. oak



3185 refined oak



1131 grey



2166 colorado oak



3162 oil oak



1137 white



2396 oriental oak

[Other colours available on request]

USL 50 | Foam skirting Classic 50



Suitable for the following flooring types

- Universal skirting matching all flooring types, particularly laminate flooring

Product information

- PVC-based polyblend (all components REACH-compliant)
- Moisture-resistant



Installation recommendations



Döllken skirting scissors



Mitre saw

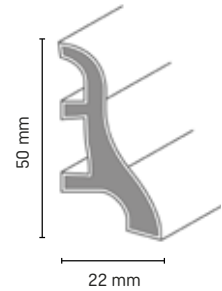

Fastening clip C (PU = 10 x 20 units)

Wholesale

- 1 PU = 25 x 4 m or 40 x 2.50 m

Accessories

LP: 1 PU = 10 units



Inner corner printed



Outer corner printed



End caps printed on left (single)



End caps printed on right (single)



Connector printed

Colours

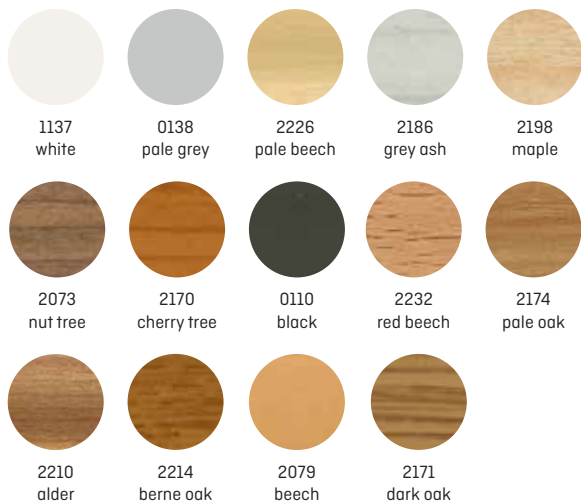

(Other colours available on request)

All sales outlets

- 1 PU = 20 x 2.50 m

Colours



(Other colours available on request)

TL 51 | Carpet infill skirting 50



Suitable for the following flooring types

- Carpet infill skirting with capping for the mounting of carpet strips

Product information

- PVC-based polyblend (all components REACH-compliant)
- Colour-matched accessories (uni)
- With self-adhesive face for the carpet strip



Installation recommendations



Döllken skirting scissors

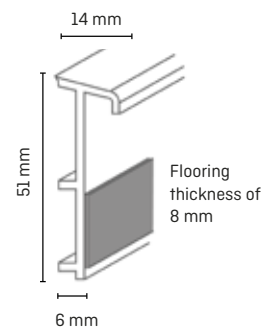

Wholesale

- 1 PU = 25 x 4 m

Colours



0117 white

[Other colours available on request]

All sales outlets

- 1 PU = 20 x 2.5 m

Accessories

1 PU = 5 units



Inner corner 90°



Outer corner 90°



End caps left and right (pairs)

Colours



0117 white



2172 beech



2175 oak



0146 dark grey

RL 10

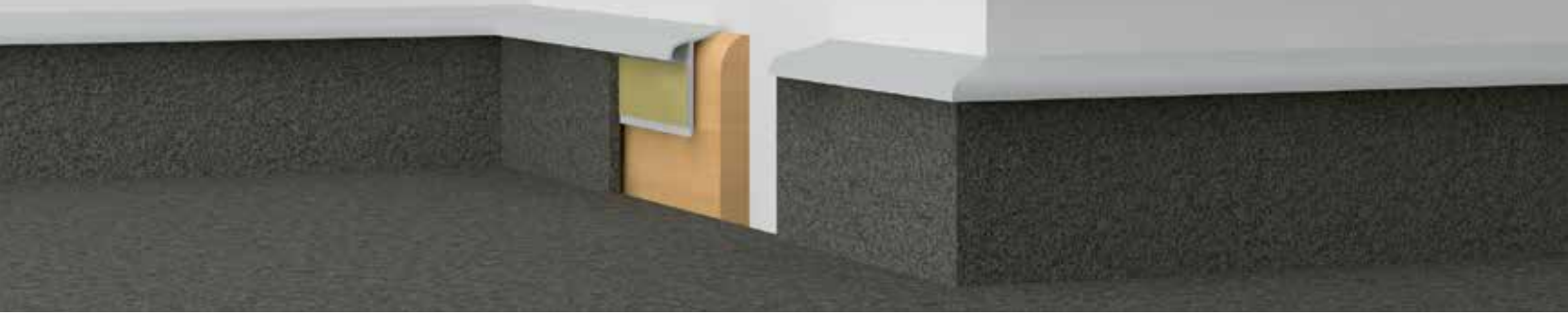

Suitable for the following flooring types

- Skirting for the renovation of existing skirting boards

Product information

- PVC-based polyblend (all components REACH compliant)
- For the renovation of existing skirting boards; for self-adhesive carpet infills



Installation recommendations



Döllken hot melt

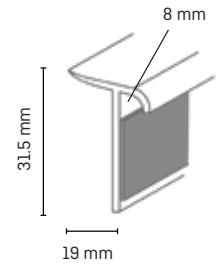

All sales outlets

- 1 PU = 20 x 2.5 m

Colours



1137
white

TLE 55

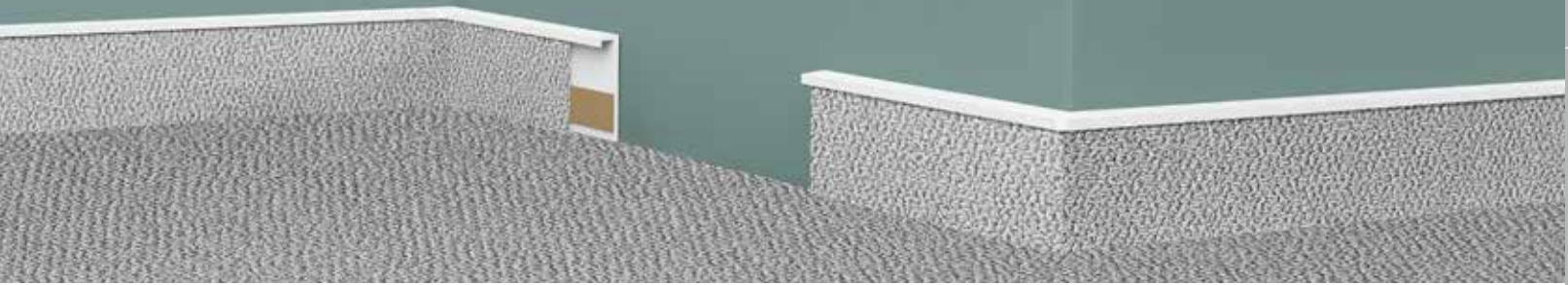

Suitable for the following flooring types

- Carpet infill skirting for the mounting of carpet strips with flexible capping

Product information

- PVC-based polyblend (all components REACH-compliant)
- with flexible capping



Wholesale

- 1 PU = 25 x 4 m

Colours

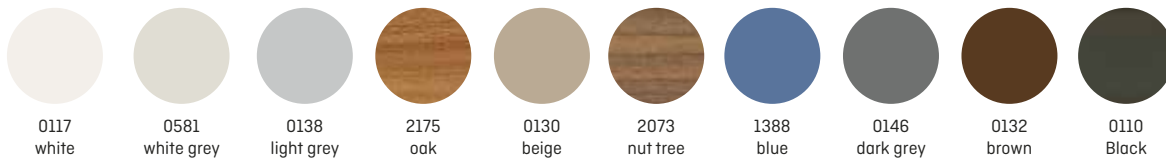

Installation recommendations



Döllken skirting scissors



Rubber hammer



Döllken hot melt



UZIN adhesive strip

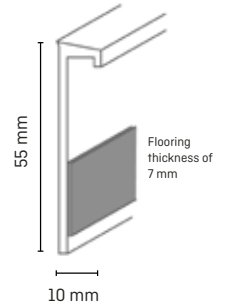

TLE 55 sk



Self-adhesive

Suitable for the following flooring types

- Carpet skirting for the mounting of self-adhesive carpet infills

Product information

- PVC-based polyblend (all components REACH-compliant)
- Self-adhesive for quick attachment to walls
- With flexible capping



Wholesale

- 1 PU = 25 x 4 m

Installation recommendations



Döllken skirting scissors



Rubber hammer

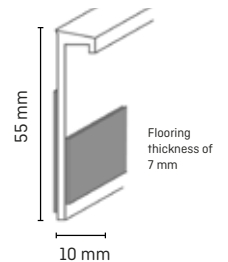

Colours

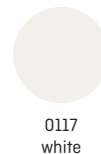

0117 white

TL 55 | Carpet infill skirting 55

Also available
as self-adhesive
variant!

Suitable for the following flooring types

- Carpet infill skirting for the mounting of carpet strips with non-flexible capping

Product information

- PVC-based polyblend (all components REACH-compliant)
- With non-flexible capping



Installation recommendations



Döllken hot melt



UZIN adhesive strip



Döllken skirting scissors

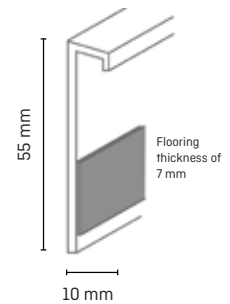

Wholesale

- 1 PU = 25 x 4 m

Colours



0117
white

All sales outlets

- 1 PU = 20 x 2.50 m

Colours (self-adhesive variant)



1137
white



0138
light grey

Tile renovation skirting



Suitable for the following flooring types

- For the renovation of PVC, linoleum and LVT flooring

Product information

- PVC-based polyblend (all components REACH-compliant)
- Covers old tiling edging and skirting (maximum cover 17 mm)
- Can be cut to different heights



Installation recommendations



Döllken
joint filler



Mitre saw

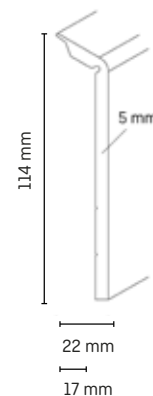

All sales outlets

- 1 PU = 20 x 2.50 m

Colours



1135
white



1064
silver-grey



1087
brown

Hard foam edging



Suitable for the following flooring types

- Carpet, vinyl and wooden flooring

Product information

- Can be used as facing in combination with other skirting or can be used alone
- Easily and flexibly installed – heat to match to wall shape
- Can be used everywhere, even in wet rooms
- Very robust and resilient
- UV-stable
- Can be painted



Installation recommendations



Döllken skirting board nails



Mitre saw

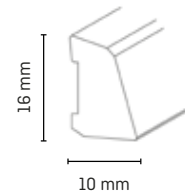

Döllken skirting scissors

All sales outlets

- 1 PU = 20 x 2.50 m

Colours



1137
white

Decorative skirting DSL 60

Also available as self-adhesive variant!



Suitable for the following flooring types

- Decorative skirting board for the mounting of decorative flooring strips

Product information

- PVC-based polyblend (all components REACH-compliant)
- Fast and simple installation through self-adhesive strips on front (self-attaching variant with adhesive strips on both sides)
- For all floor coverings of thickness up to 5 mm



Installation recommendations



Döllken hot melt



UZIN adhesive strip



Döllken skirting scissors

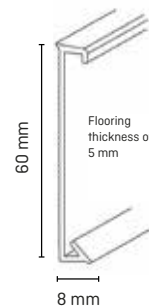

All sales outlets

• 1 PU = 10 x 2.50 m

Colours

1137 white	1091 chocolate brown	1083 stainless steel	1084 sand	1063 silver	1064 silver-grey

Colours (self-adhesive variant)

1010 cappuccino	1091 chocolate	1086 light beige	1084 sand

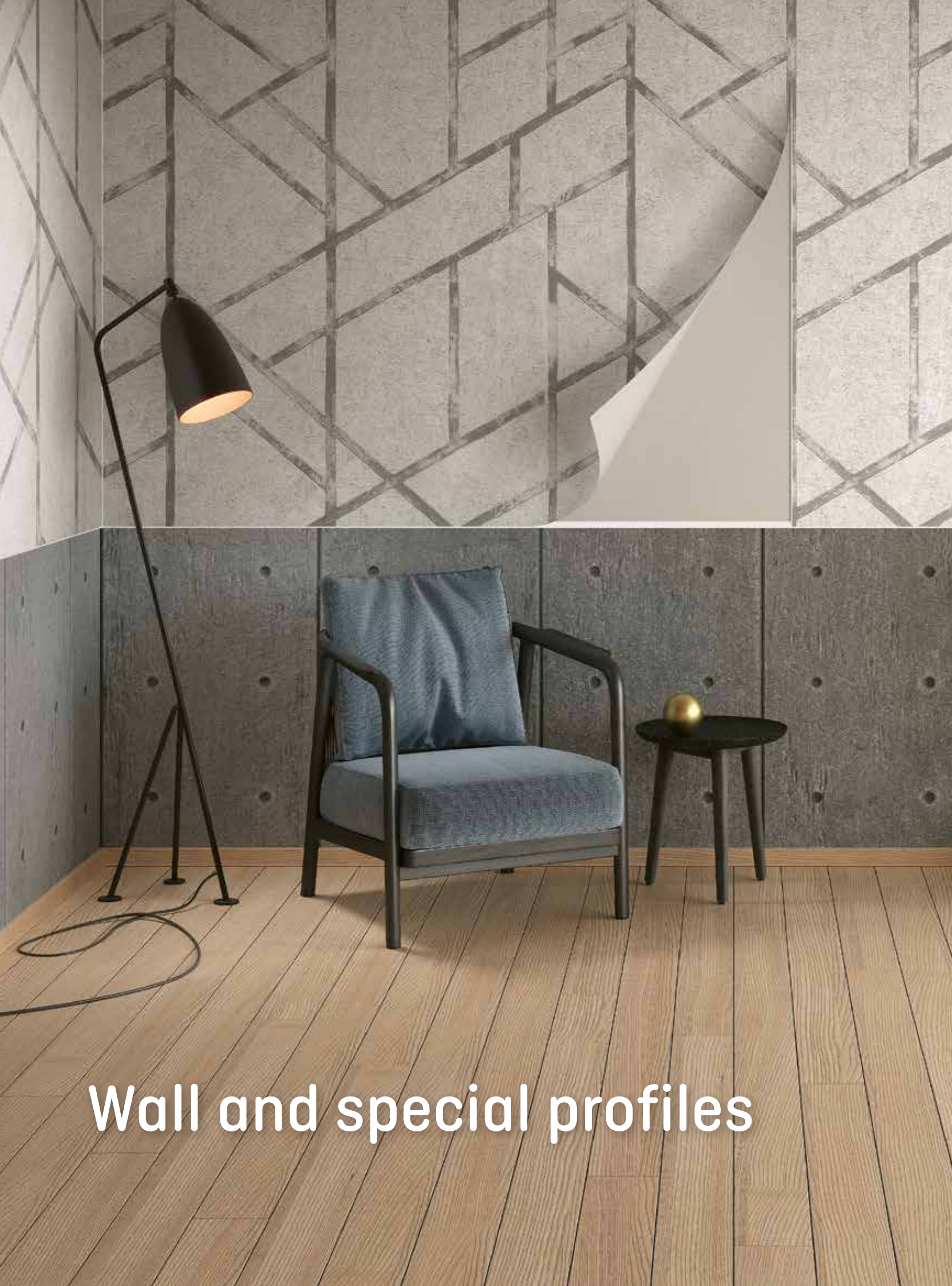

Wall and special profiles

Reliable protection of sites subject to extensive stresses

Our special profiles have the following characteristics and advantages

- Elegant transition between floors and walls
- Can be securely fixed to stairs with various coverings
- Flexible in use and completely reliable
- Conform to the stipulations of the REACH regulation; free of all hazardous softening agents

Overview of wall and special profiles

(Wholesale | All sales outlets)

	Page
TAL 20	71
TEL 20 life	72
TEL 20 life round	72
TIW 20 life	73
TEL 40 life	73
Door frame profile	74
Door frame profile XL	74
WL 10/10, 20/20, 30/30	75
Cornice 20	75
HK 100	77
HK 15/15, 20/20, 25/25	77
EL 3.5	78
EL 8	79
Heating pipe cover skirting	80
Universal self-adhesive flat profile	81
Quarter round 12	82
Quarter round 15	83

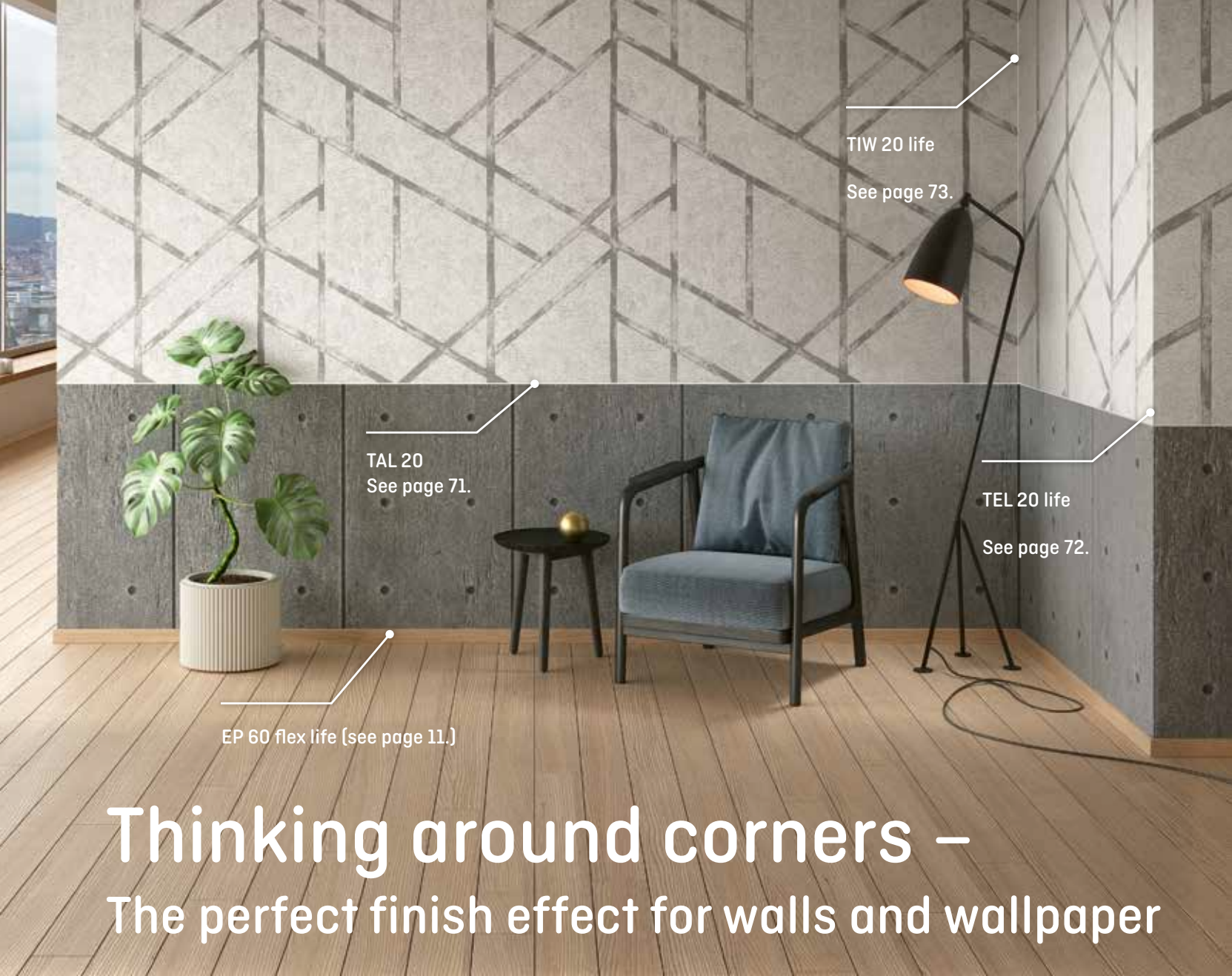

TIW 20 life
See page 73.

TAL 20
See page 71.

TEL 20 life
See page 72.

EP 60 flex life (see page 11.)

Thinking around corners – The perfect finish effect for walls and wallpaper



TIW 20 life



TAL 20



TEL 40 life

TAL 20



- Wall trim for the neat finishing of wallpaper edges

Product information

- Made of ABS-based polyblend, for the simple and clean finishing of wallpaper edges
- Can be painted
- Trim for various edgings (e.g. borders, wallpaper etc.), window and door frames

Installation recommendations



Döllken
skirting scissors



Döllken
mitre shears

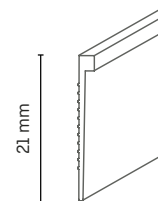

All sales outlets

- 1 PU = 40 x 2.60 m

Colours



1137
white



TEL 20 life

- Corner trim for clean wallpaper edging (outer corner)

Product information

- Made of ABS-based polyblend, for the simple and clean finishing of wallpaper edges
- Can be painted
- Can be separated for use
- Simply score to fit into obtuse angles

Installation recommendations



Döllken skirting scissors



Döllken mitre shears

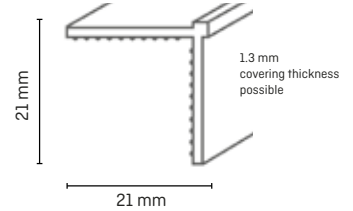

All sales outlets

- 1 PU = 20 x 2.60 m

Colours



1137 white



1016 black-metallic



1017 silver-metallic



TEL 20 life round

- Rounded corner trim for clean wallpaper edging (external corner), for sensitive sites, such as nursery schools

Product information

- Made of ABS-based polyblend, for the simple and clean finishing of wallpaper edges
- Can be painted
- Can be separated for use
- Simply score to fit into obtuse angles

Installation recommendations



Döllken skirting scissors



Döllken mitre shears

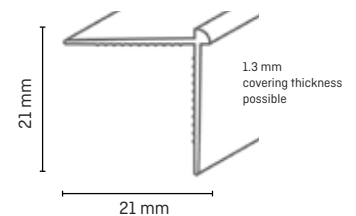

All sales outlets

- 1 PU = 20 x 2.60 m

Colours



1137 white



TIW 20 life

- Inner corner trim for clean wallpaper edging

Product information

- Made of ABS-based polyblend, for the simple and clean finishing of wallpaper edges
- Can be painted
- Simply score to fit into obtuse angles

Installation recommendations



Döllken skirting scissors



Döllken mitre shears

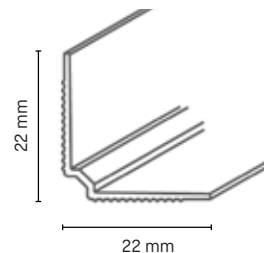

All sales outlets

- 1 PU = 20 x 2.60 m

Colours



1137
white



TEL 40 life

- Corner trim for clean wallpaper edging (outer corner)

Product information

- Made of ABS-based polyblend, for the simple and clean finishing of wallpaper edges
- Can be painted
- Can be separated for use
- For thicker wall coverings

Installation recommendations



Döllken skirting scissors



Döllken mitre shears

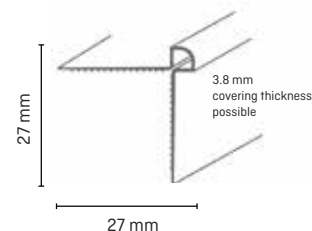

All sales outlets

- 1 PU = 20 x 2.60 m

Colours



1137
white



Door frame profile



Can be used as follows

- To frame door openings and harmonised continuation of/transition with skirting

Product information

- HDF core encased in a chlorine-free PP/TPE-based polyblend, with flexible soft lip at top
- Can be seamlessly installed along door edges
- Specially curved geometry ensures better installation along door frame edges

Installation recommendations



Döllken
hot melt
adhesive

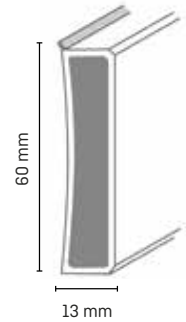

www.blauer-engel.de/uz176

All sales outlets

- 1 PU = 10 x 2.20 m

Colours



1013
white



1171
white



1144
black

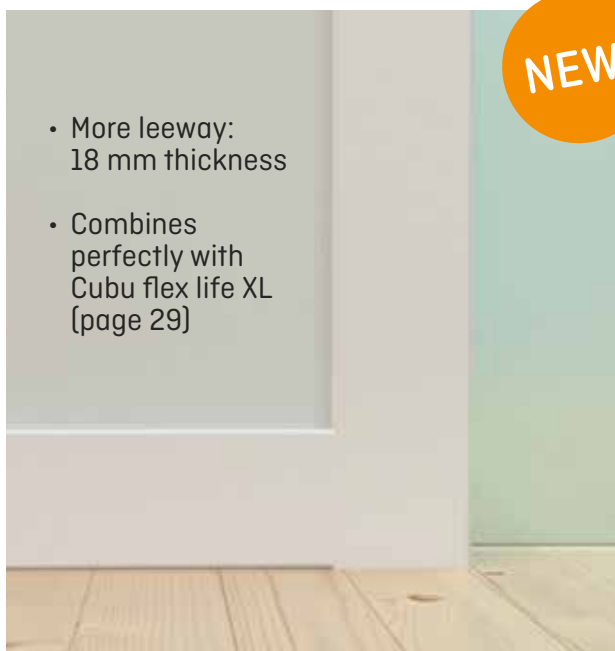

- More leeway:
18 mm thickness
- Combines
perfectly with
Cubu flex life XL
(page 29)

Door frame profile XL

- 1 PU = 8 x 2.20 m

Installation recommendations



Döllken
hot melt
adhesive

Colours



1013
white



1144
black

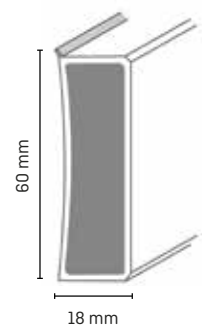

www.blauer-engel.de/uz176

WL 10/10, 20/20, 30/30



Suitable for all types of coverings

- All-rounder trim for all types of inner and outer corners

Product information

- PVC-based polyblend (all components REACH-compliant)
- Printed on both sides

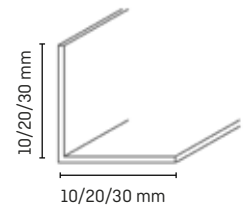

All sales outlets

- WL 10/10: 1 PU = 20 x 2.5 m*
- WL 20/20: 1 PU = 10 x 2.5 m
- WL 30/30: 1 PU = 10 x 2.5 m

*WL 10/10 available in white only!

Colours



Corner trim 20



Suitable for all types of coverings

- All-rounder trim for all types of inner corners

Product information

- Made of hard plastic foam

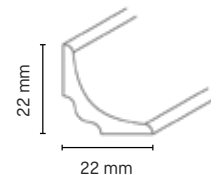

All sales outlets

- 1 PU = 20 x 2.5 m

Colours

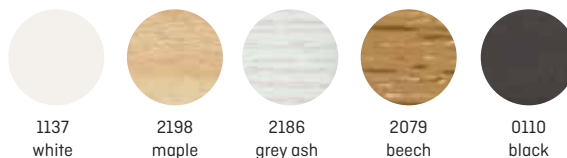

Concave skirting systems

Single section system:
HK 100

Two section systems:
HK 15x15 / HK 20x20/
HK 25x25 / HK 30x30
+ EL 3.5 / EL 3.5 sk / EL 8

Our concave skirtings ensure the more stringent hygiene requirements are met in more sensitive areas with flexible flooring, such as canteens, foodstuff-processing areas, laboratories and hospitals and other sites requiring greater cleanliness. The concave shape means that flooring in the skirting area can be more easily cleaned and less soiling will accumulate.

- ✓ For the perfect concave finish to flooring
- ✓ The concave shape makes cleaning and upkeep easier
- ✓ Prevents accumulation of soiling and bacteria
- ✓ Protects against breakages of flooring in the concave skirting area

See the following pages for more information.

HK 100



Suitable for the following flooring types

- Concave skirting for elastic flooring

Product information

- PVC-based polyblend (all components REACH-compliant)
- For transition of flooring taken up the wall

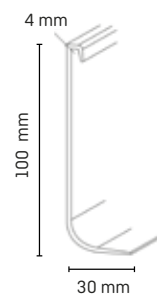

All sales outlets

- 1 PU = 40 x 2.50 m

Colours



1137
white



0138
pale grey



1436
alumetallic



0110
black

HK 15/15, 20/20, 25/25



Suitable for the following flooring types

- Concave skirting for elastic flooring

Product information

- PVC-based polyblend (all components REACH-compliant)
- For transition of flooring taken up the wall



Installation recommendations



Döllken
skirting scissors



UZIN adhesive
strip

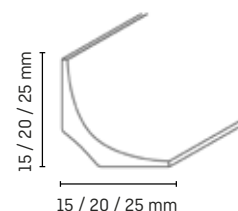

All sales outlets

- HK 15/15: 1 PU = 20 x 2.5 m
- HK 20/20: 1 PU = 20 x 2.5 m
- HK 25/25: 1 PU = 20 x 2.5 m

Colours



0110
black

EL 3.5



Suitable for the following flooring types

- Concave skirting for elastic flooring

Product information

- PVC-based polyblend (all components REACH-compliant)
- For transition of flooring taken up the wall

Installation recommendations



Döllken skirting scissors



Döllken mitre shears

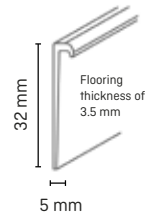

Wholesale

- 1 PU = 25 x 4 m



Colours



1137 white



0138 pale grey



0146 dark grey



0130 beige



0132 brown



0110 black

Self-adhesive variant: EL 3.5 sk

Suitable for the following flooring types

- Concave skirting for elastic flooring

Product information

- PVC-based polyblend (all components REACH-compliant)
- For transition of flooring taken up the wall
- Self-adhesive version:
Firm attachment thanks to Toptac adhesive strip by UZIN
- ✓ System guarantee
- ✓ Dimensionally stable
- ✓ Solvent-free
- ✓ Softening agent-resistant

Installation recommendations



Döllken skirting scissors



Döllken mitre shears

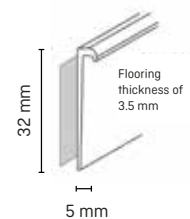

Wholesale

- 1 PU = 20 x 2.50 m



Colours



1137 white



0138 pale grey



0146 dark grey



0130 beige



0132 brown



0110 black

EL 8

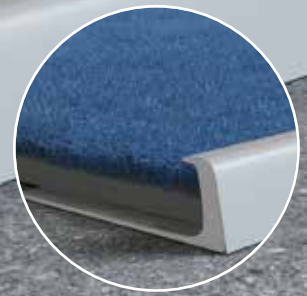

Suitable for the following flooring types

- Edging for flooring

Product information

- Made of PVC-based hard polyblend
(all components are REACH-compliant)

Installation recommendations



Döllken
skirting scissors



Döllken
mitre shears

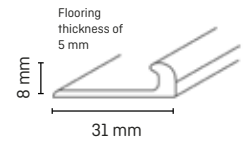

Wholesale

- 1 PU = 25 x 4 m



Colours



1137
white



0138
pale grey



0146
dark grey



0130
beige



0132
brown



0110
black

Heating pipe cover skirting



Suitable for the following flooring types

- Universal in use

Product information

- Hard plastic with film covering
- Made of double-walled plastic
- Soft plastic lip facilitates installation even on uneven walls
- Pipe clips serve to stabilise pipes and fix skirting in place
- Matching accessories for the perfect finish
- Rough cut to mitre (accessories cover cut section)

Installation recommendations



Mitre saw



Döllken notching pliers

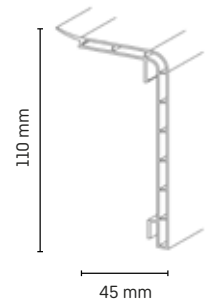

All sales outlets

- 1 PU = 10 x 2 m

Accessories

SS: 1 PU = 5 x 1 units

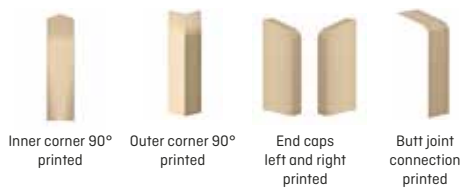

Mounting

- pipe clip
- SS: 1 PU = 10 x 5 units

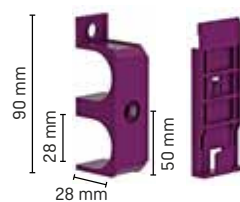

Gaps for heating pipes can easily be created using notching pliers



Colours

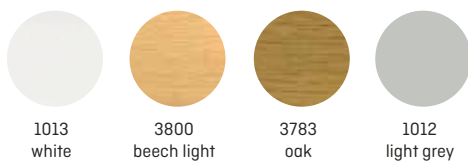

Universal flat trim, self-adhesive

NEW!

Suitable for the following flooring types

- Trim for, e.g., balcony or terrace doors

Product information

- HDF core, encased with chlorine-free PP-based polyblend
- Surfaces are resistant to mechanical stress and moisture
- Quickly installed thanks to self-adhesive strip on rear
- Punchable (closed outer corner)

Installation recommendations



Döllken punch



Döllken skirting scissors



Döllken mitre shears

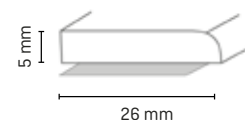

All sales outlets

- 1 PU = 40 x 2.50 m

Colours

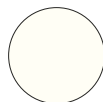

1013 white



1209 anthracite



1408 white



1063 silver



1010 cappuccino



Quarter round 12



Suitable for the following flooring types

- PVC trim for laminates

Product information

- Made of plastic hard foam (PVC)
- Can be mitred with fine-toothed saw
- Installation optionally by nailing, screwing or gluing
- Flexibly adapting to slight curvature of walls
- Many applications possible through popular decors and colours



Installation recommendations



Döllken
skirting board
nails



Döllken
skirting scissors



Döllken
mitre shears

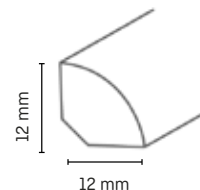

All sales outlets

- 1 PU = 20 x 2.0 m

Colours

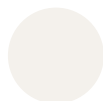

1137
white



2186
grey ash



2198
maple



2079
beech



2171
dark oak

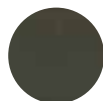

0110
black

Quarter round 15



Suitable for the following flooring types

- PVC trim for laminates

Product information

- Made of plastic hard foam (PVC)
- Can be mitred with fine-toothed saw
- Installation optionally by nailing, screwing or gluing
- Flexibly adaptation to slight curvature of walls
- Many applications possible thanks to popular decors and colours



Installation recommendations



Döllken
Skirting board
nails



Döllken
skirting scissors



Döllken
mitre shears

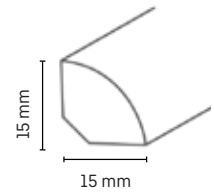

All sales outlets

- 1 PU = 20 x 2.5 m

Colours



1137
white



2171
dark oak



2244
ash



2079
beech



0110
black



1055
dark grey

Flexible skirtings



Free of hazardous softening agents: In accordance with the REACH regulations, our flexible skirtings are phthalate-free

The easy way to create clean transitions to walls – flexible and straightforward

All our flexible skirtings are characterised by the following properties and advantages:

- For use with flexible floorings
- Installed in no time
- Provide for harmonious transition between walls and floors
- All our flexible skirtings are free of hazardous softening agents in accordance with the REACH regulation



Overview of flexible skirtings

(Wholesale | All sales outlets)

	Page
WL 50, 60, 80, 100	86
WLK 50, 60	90
WLK 70, 80, 100	91
WLK 20 Remur	92
Flexible skirting basic	93
Angled basic	94

Our services are as flexible as our skirtings.
Our skirtings are available on request in other heights as PVC-free life variants and in self-adhesive versions.



WL 50, 60, 80, 100



Suitable for the following flooring types

- Flexible skirting for PVC, CV and linoleum floorings

Product information

- PVC-based polyblend
(all components REACH compliant)



Installation recommendations



UZIN adhesive strip



Rubber hammer



Mitre shears



Easy-Scooter



skirting scissors

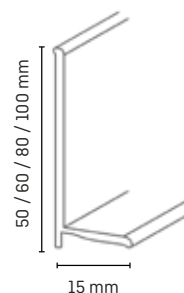

All sales outlets

- 1 sales unit = 1 x 50 m (on roll)

Colours WL 50



Colours WL 60



Colours WL 80, WL 100



Because we know what is important, we ensure all our flexible skirtings are phthalate-free.



Greater adhesion than ever!



The self-adhesive WLK flexible skirting range

- ✓ New geometry for more flexibility.
- ✓ Excellent adhesion thanks to use of a top brand adhesive strip.
- ✓ Up to 50% time-saving as adhesive already present.
- ✓ Easy-Scooter additionally facilitates installation.



WLK 50, 60



Suitable for the following flooring types

- Flexible skirting for PVC, CV and Linoleum floorings

Product information

- PVC-based polyblend (all components REACH-compliant)
- Self-adhesive version: excellent adhesion thanks to the **Remur adhesive strip by UZIN**
 - ✓ System guarantee
 - ✓ Dimensionally stable
 - ✓ Solvent-free
 - ✓ Softening agent-resistant

Installation recommendations



Rubber hammer



Easy-Scooter



skirting scissors



Mitre shears

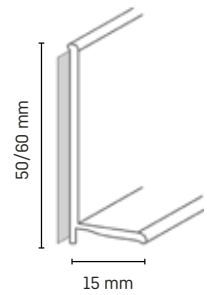

All sales outlets

- 1 PU = 1 x 50 m (on roll)

Colours WLK 50

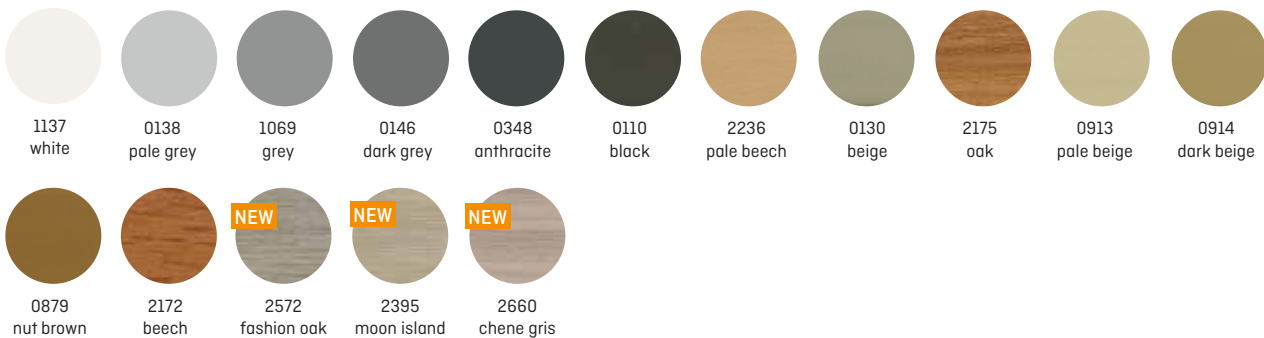

Colours WLK 60



WLK 70, 80, 100



Suitable for the following flooring types

- Flexible skirting for PVC, CV and linoleum floorings

Product information

- PVC-based polyblend (all components REACH compliant)
- Self-adhesive version: excellent adhesion thanks to the **Remur adhesive strip by UZIN**
 - ✓ System guarantee
 - ✓ Dimensionally stable
 - ✓ Solvent-free
 - ✓ Softening agent-resistant

Installation recommendations

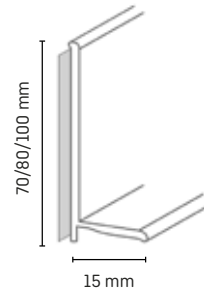

All sales outlets

- 1 PU = 1 x 50 m (on roll)

Colours WLK 70

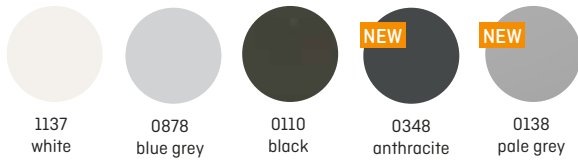

Colours WLK 80



Colours WLK 100

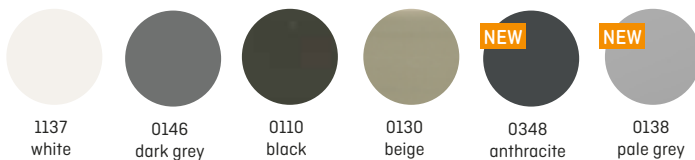

WLK 20 Remur



Suitable for the following flooring types

- Flexible skirting for PVC, CV and linoleum floorings

Product information

- PVC-based polyblend (all components REACH compliant)
- Can be used for inner and outer corners
- Can be angled
- Self-adhesive version: excellent adhesion thanks to the **Remur adhesive strip by UZIN**
 - ✓ System guarantee
 - ✓ Dimensionally stable
 - ✓ Solvent-free
 - ✓ Softening agent-resistant

Installation recommendations



Rubber hammer



Easy-Scooter



skirting scissors



Mitre shears



All sales outlets

- 1 PU = 1 x 50 m (on roll)

Colours



1137
white



0146
dark grey

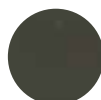

0110
black

Flexible skirting basic



Suitable for the following flooring types

- Flexible skirting for PVC, CV and linoleum floorings

Product information

- PVC-based polyblend (all components REACH compliant)
- Self-adhesive with adhesive strip to rear

Installation recommendations



Rubber hammer



Döllken skirting scissors



Mitre shears

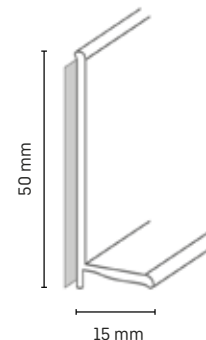

i We recommend using WLK profiles with Remur to ensure form- and dimension-stable adhesion (see page 90, 91 and 92).

All sales outlets

- 1 PU = 4 x 10 m
- 1 PU = 4 x 25 m

Colours (PU = 4 x 25 m)



1137 white

1054 grey

2172 beech

2175 oak

Colours (PU = 4 x 10 m)

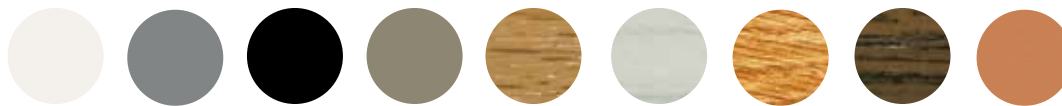

1137 white

1054 grey

0110 Black

0130 beige

2172 beech

2186 Ash-grey

2175 oak

2227 oak oak

0132 brown



Angled basic



Suitable for the following flooring types

- Flexible skirting for PVC, CV and linoleum floorings

Product information

- Soft plastic skirting
- For use in inner and outer corners
- Can be angled
- Self-adhesive with adhesive strip to rear

Installation recommendations



Rubber hammer



Döllken skirting scissors



Easy-Scooter



Mitre shears

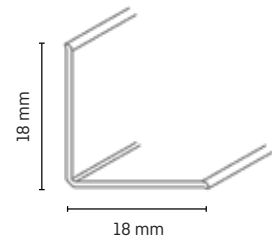

We recommend using WLK profiles with Remur to ensure form- and dimension stable adhesion (see page 90, 91 and 92).

All sales outlets

- 1 PU = 4 x 25 m** (PU size available only in white)
- 1 PU = 5 x 5 m



Colours



1137 white**



1054 grey



0110 black



0132 brown



0130 beige



2172 beech



0138 light grey



2175 oak



2211 nut tree



Easy-Scooter

See page 124.



Scan now and view installation tips on our YouTube channel!

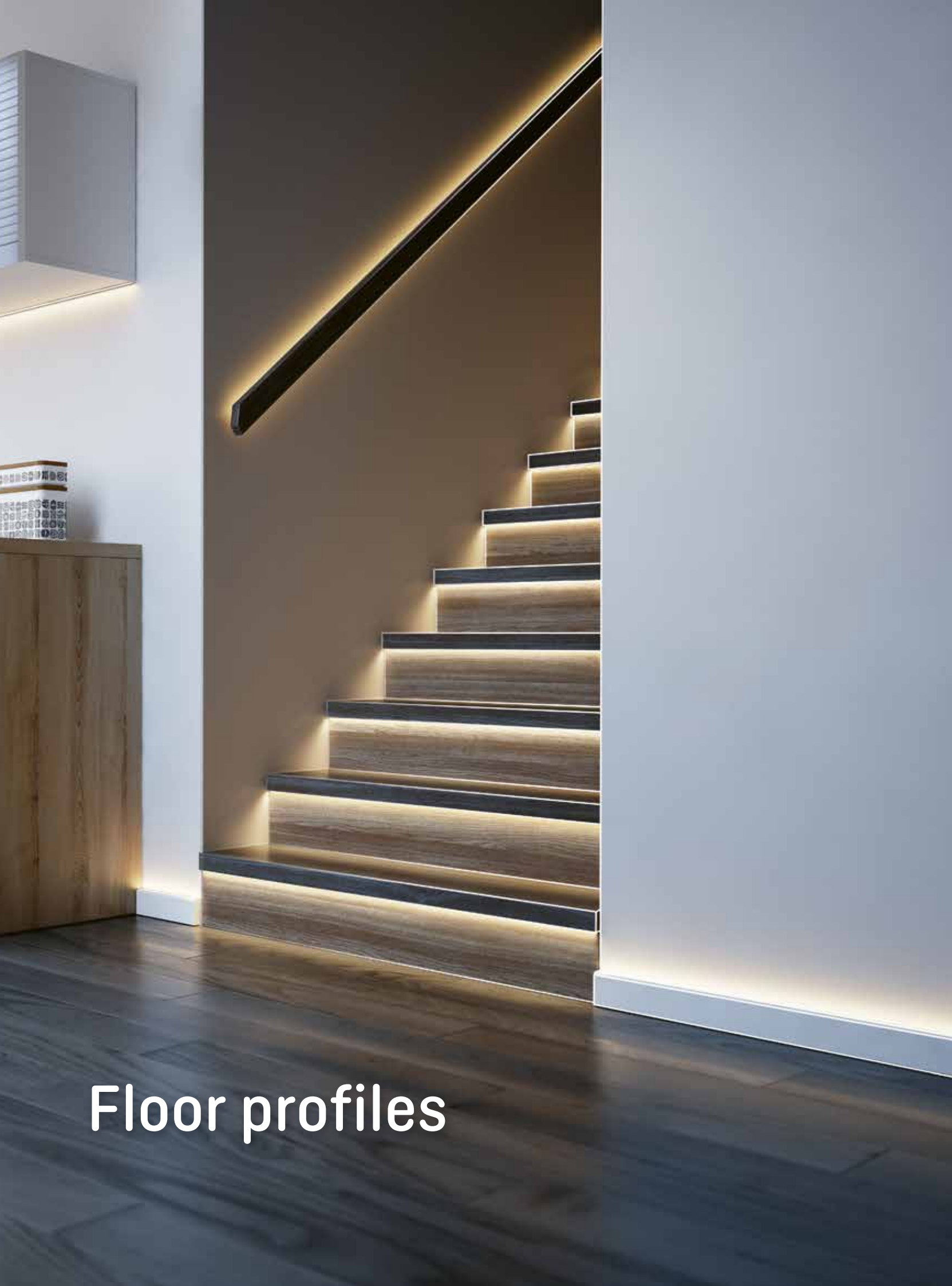

Floor profiles

Reliable protection of sites subject to extensive stresses

All our floor profiles are characterised by the following properties and advantages:

- Elegant transition between floors and walls
- Can be securely fixed to stairs with various coverings
- Completely reliable
- Conform to the stipulations of the REACH regulation; free of all hazardous softening agents

Overview of floor profiles

(Wholesale | All sales outlets)

	Page
TKNG A 40	100
TKNG A 40 sk	101
TKNG A 45	102
TKNG A 45 sk	103
TKNG A 65	104
TKNG A 65 sk	105
TKNG 3,5 40	106
TKNG 2,5 40	107
Repair angle	108
Stair stringer strip TWP45/3	109
Step mat angle strip	109
Frame edge strip SK	110
Double frame edge strip SK	110
Plastic transition strip	111
Transition strip SK	111

The new innovative stair edging programme TKNG

The next generation of stair edging has arrived: Whether used on risers or treads, the new stair edging strips in the TKNG range provide for bright highlights thanks to the glowing edges. They can readily be installed by hand, saving time and trouble.



Repair angle for the
stabilization of stair



Stops sliding
At least anti-slip class R 10



Quickly installed
...Or even more rapidly with
the self-adhesive variants



Glowing edge hinders falls
and provides guidance

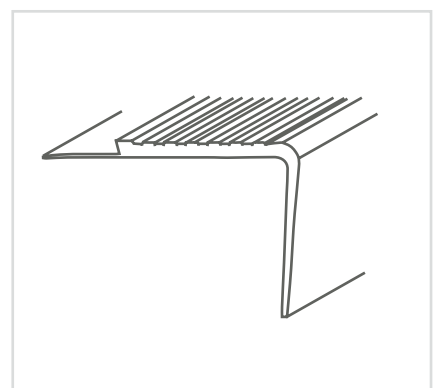
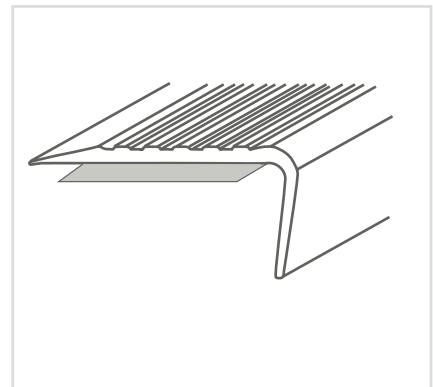

Phthalate-free: can be readily used in sensitive areas and living rooms

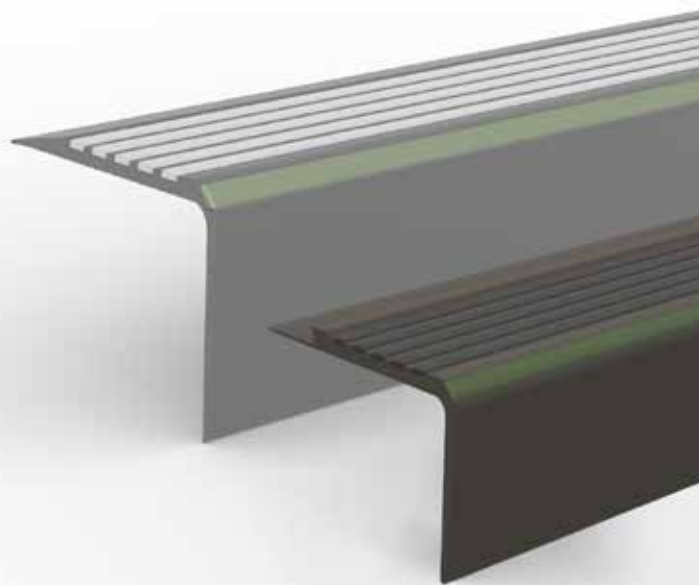

Colour combinations	TKNG A40	TKNG A45	TKNG A65	TKNG 2.5 40	TKNG 3.5 40
pale grey/dark grey	✓	✓	✓	✓	✓
dark grey/pale grey	✓	✓	✓	✓	✓
black/pale grey	✓	✓	✓	✓	✓
aluminium/dark grey	✓	✓	✓	✓	✓
NEW: black/black	✓	-	✓	✓	✓
champagne/dark grey	✓	✓	✓	✓	✓
NEW: dark grey/dark grey	✓	✓	✓	-	-
Self-adhesive variants available	✓	✓	✓	-	-

Special colours and individual colour combinations available on request

NOW NEW: TKNG A 40, A 45 and A 65 also available in self-adhesive versions!



- ✓ Simple, quick and clean: 3 – 5 x more rapid installation
- ✓ Solvent-free adhesive
- ✓ Excellent adhesion thanks to Remur top brand adhesive strip by UZIN
- ✓ Can be replaced at any time
- ✓ No laying out and pre-application of adhesive necessary

TKNG A 40

Glowing edge

Suitable for the following flooring types

- Step edges/tread strip for decorative coverings, CV and linoleum

Product information

- PVC-based polyblend (all components REACH-compliant)
- Slim in appearance
- Anti-slip thanks to structured surface (complies with DIN 51130:2014 - anti-slip class **R10**)
- Edge with phosphorescent glow prevents falls in darkness

Installation recommendations



Döllken skirting scissors



Rubber hammer



Döllken mitre shears



Repair angle

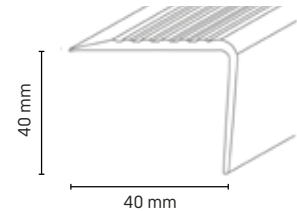

All sales outlets

- 1 PU = 10 x 2.5 m (also available in small units for filling)



Glowing edge prevents falls in the dark!



Colours



Base colour
Raised profile
Groove colour

0138	0146	1160	0110	1245	0110	0146
pale grey	dark grey	aluminium	black	champagne	black	dark grey
0146	0138	0146	0138	0146	0110	0146
dark grey	pale grey	dark grey	pale grey	dark grey	black	dark grey

TKNG A 40 sk

Self-adhesive version

Glowing edge

Suitable for the following flooring types

- Step edges/tread strip for decorative coverings, CV and linoleum

Product information

- PVC-based polyblend (all components REACH compliant)
- Slim in appearance
- Anti-slip thanks to structured surface (complies with DIN 51130:2014 - anti-slip class **R10**)
- Edge with phosphorescent glow prevents falls in darkness
- **Self-adhesive version** with Remur top brand adhesive strip by UZIN

Installation recommendations



Döllken skirting scissors



Rubber hammer



Döllken mitre shears



Repair angle

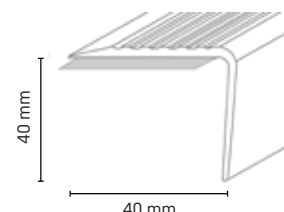

All sales outlets

- 1 PU = 10 x 2.5 m (also available in small units for filling)



Glowing edge prevents falls in the dark!

i

Colours

			NEW		NEW	NEW	NEW
Basic colour	0138	0146	1160	0110	1245	0110	0146
Raised profile	pale grey	dark grey	aluminium	black	champagne	black	dark grey
Groove colour	0146	0138	0146	0138	0146	0110	0146
	dark grey	pale grey	dark grey	pale grey	dark grey	black	dark grey



- 3 – 5 x more rapid installation ✓
- Solvent-free adhesive, excellent attachment ✓
- No laying out and pre-application of adhesive necessary ✓



See for yourself the ease of installation!

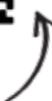

TKNG A 45



Suitable for the following flooring types

- Step edges/tread strip for decorative coverings, CV and linoleum

Product information

- Tread strip made of PVC-based polyblend
- (all components are REACH-compliant)
- Slim in appearance
- Anti-slip thanks to structured surface (complies with DIN 51130:2014 - anti-slip class at least **R10**)
- Edge with phosphorescent glow prevents falls in darkness

Installation recommendations



Döllken skirting scissors



Rubber hammer



Döllken mitre shears



Repair angle

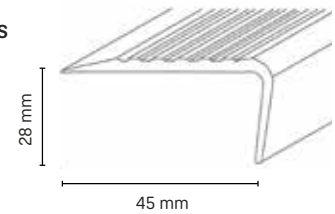

All sales outlets

- 1 PU = 10 x 2.5 m (also available in small units for filling)



Glowing edge prevents falls in the dark!



Colours

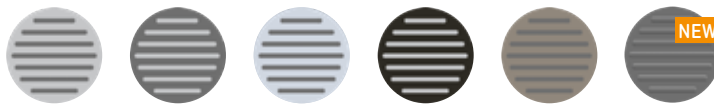

Basic colour
Raised profile
Groove colour

0138	0146	1160	0110	1245	0146 NEW
pale grey	dark grey	aluminium	black	champagne	dark grey
0146	0138	0146	0138	0146	0146
dark grey	pale grey	dark grey	pale grey	dark grey	dark grey

TKNG A 45 sk

Self-adhesive version



Suitable for the following flooring types

- Step edges/tread strip for decorative coverings, CV and linoleum

Product information

- Tread strip made of PVC-based polyblend
- [All materials are REACH-compliant]
- Slim in appearance
- Anti-slip thanks to structured surface [complies with DIN 51130:2014 - anti-slip class **R10**]
- Edge with phosphorescent glow prevents falls in darkness
- **Self-adhesive version** with Remur top brand adhesive strip by UZIN

Installation recommendations



Döllken skirting scissors



Rubber hammer



Döllken mitre shears



Repair angle

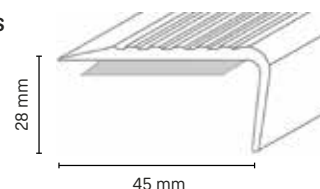

All sales outlets

- 1 PU = 10 x 2.5 m [also available in small units for filling]



Glowing edge prevents falls in the dark!



Colours self-adhesive versions

	0138	0146	1160 NEW	0110	0110 NEW
Basic colour	pale grey	dark grey	aluminium	black	black
Raised profile					
Groove colour	0146 dark grey	0138 pale grey	0146 dark grey	0138 pale grey	0110 black



- ✓ 3 – 5 x more rapid installation
- ✓ Solvent-free adhesive, excellent attachment
- ✓ No laying out and pre-application of adhesive necessary



See for yourself the ease of installation!



TKNG A 65



Suitable for the following flooring types

- Step edges/tread strip for decorative coverings, CV and linoleum

Product information

- Tread strip made of PVC-based polyblend
- (All materials are REACH-compliant)
- Slim in appearance
- Anti-slip thanks to structured surface (complies with DIN 51130:2014 - anti-slip class **R10**)
- Edge with phosphorescent glow prevents falls in darkness

Installation recommendations



Döllken skirting scissors



Rubber hammer



Döllken mitre shears



Repair angle

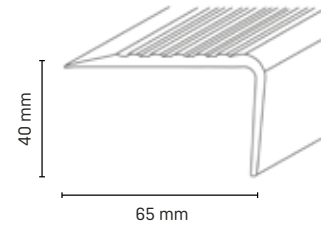

All sales outlets

- 1 PU = 10 x 2.5 m (also available in small units for filling)



Glowing edge prevents falls in the dark!



Colours

Basic colour	0138	0146	1160	0110	1245	0110	0146
Raised profile	pale grey	dark grey	aluminium	black	champagne	black	dark grey
Groove colour	0146	0138	0146	0138	0146	0110	0146
	dark grey	pale grey	dark grey	pale grey	dark grey	black	dark grey

TKNG A 65 sk



Suitable for the following flooring types

- Step edges/tread strip for decorative coverings, CV and linoleum

Product information

- Tread strip made of PVC-based polyblend (all components are REACH-compliant)
- Slim in appearance
- Anti-slip thanks to structured surface (complies with DIN 51130:2014 - anti-slip class **R10**)
- Edge with phosphorescent glow prevents falls in darkness
- **Self-adhesive version** with Remur top brand adhesive strip by UZIN available on request

Installation recommendations



Döllken skirting scissors



Rubber hammer



Döllken mitre shears



Repair angle

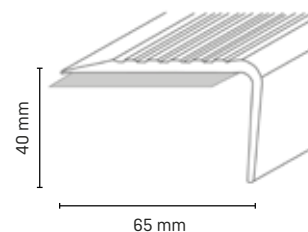

All sales outlets

- 1 PU = 10 x 2.5 m (also available in small units for filling)



Glowing edge prevents falls in the dark! i

Colours self-adhesive versions

Basic colour	0138	0146	1160	0110	1245	0110	0146
Raised profile	pale grey	dark grey	aluminium	black	champagne	black	dark grey
Groove colour	0146	0138	0146	0138	0146	0110	0146
	dark grey	pale grey	dark grey	pale grey	dark grey	black	dark grey



- ✓ 3 – 5 x more rapid installation
- ✓ Solvent-free adhesive, excellent attachment
- ✓ No laying out and pre-application of adhesive necessary



See for yourself the ease of installation!

TKNG 3.5 40

Glowing edge



Suitable for the following flooring types

- Step edges/tread strip for decorative coverings, CV and linoleum

Product information

- Tread strip made of PVC-based polyblend
- (all components are REACH-compliant)
- Slim in appearance
- Anti-slip thanks to structured surface (complies with DIN 51130:2014 - anti-slip class **R10**)
- Phosphorescent/glowing edge

Installation recommendations



Döllken skirting scissors



Rubber hammer



Döllken mitre shears



Repair angle

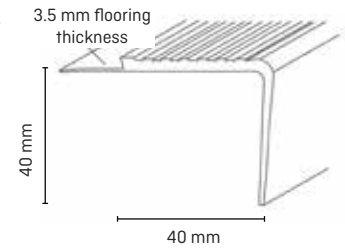

All sales outlets

- 1 PU = 10 x 2.5 m
(also available in small units for filling)

Colours



Basic colour
Raised profile 0138
pale grey



0146
dark grey



1160
aluminium



0110
black



1245
champagne



0110
black

Groove colour 0146
dark grey

0138
pale grey

0146
dark grey

0138
pale grey

0146
dark grey

0110
black



Glowing edge prevents falls in the dark!



With the glowing
TKNG step edging strips...

TKNG 2.5 40

Glowing edge



Suitable for the following flooring types

- Step edges/tread strip for decorative coverings, CV and linoleum

Product information

- Tread strip made of PVC-based polyblend
- [all components are REACH-compliant]
- Slim in appearance
- Anti-slip thanks to structured surface [complies with DIN 51130:2014 - anti-slip class **R10**]
- Phosphorescent/glowing edge

Installation recommendations



Döllken skirting scissors



Rubber hammer



Döllken mitre shears



Repair angle

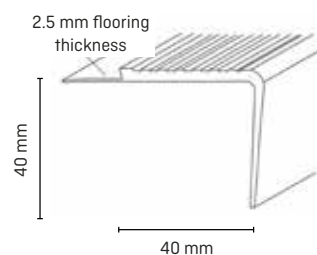

All sales outlets

- 1 PU = 10 x 2.5 m
[also available in small units for filling]



Colours

	0138	0146	1160	0110	1245	0110 NEW
Basic colour	pale grey	dark grey	aluminium	black	champagne	black
Raised profile						
Groove colour	0146 dark grey	0138 pale grey	0146 dark grey	0138 pale grey	0146 dark grey	0110 black

Glowing edge prevents falls in the dark!



...bring light into darkness

Repair angle

NEW

Repair angle for stairs are used in the commercial and private sectors when steps are damaged, for example due to cracks, spalling, unevenness or wear.

Product information

- new improved, more stable variant for stabilizing stairs
- optimized length of 1.25 m
- a profile for the renovation of concrete, stone and wooden stairs
- new shape with function! Especially suitable for bonding the coverings to the risers
- high load-bearing capacity
- galvanized surface protects against corrosion
- easy, quick and clean to apply
- long-lasting protection for stair nosings and corners
- easy installation thanks to fastening options (drill holes) for nails and screws

Installation recommendations



Screws

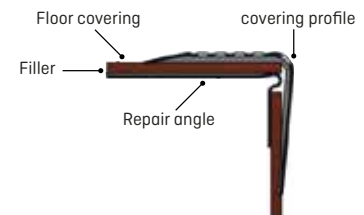
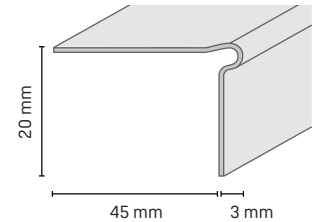

All sales outlets

- 1 PU = 20 x 1,25 m

Cardboard packaging sealed with adhesive tape and PU Paper labels with article inscription

Stair stringer strip TWP45/3



Suitable for all types of coverings

- Side strip for steps

Product information

- Made of ABS-based polyblend
- For the perfect covering of stair stringers

Installation recommendations



Döllken skirting scissors



Döllken mitre shears

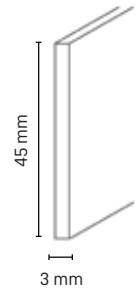

All sales outlets

- 1 PU = 20 x 2.5 m

Colours



1230 white

Step mat angle strip



NEW

Available as self-adhesive version on request!

Suitable for all types of coverings

- Helps prevent damage to steps

Product information

- Made of hard PVC, ideal for stair step mats
- The step mat angle strip gives form and stability to edges
- The strips are adhered to the rear of the step covering

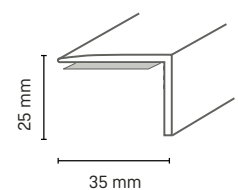
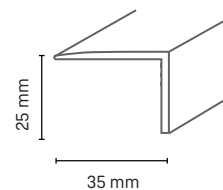

Self-adhesive variant (on request)

All sales outlets

- 1 PU = 100 x 0.63 m

Colours



0110 black

Frame edge strip SK

Self-adhesive

Suitable for the following flooring types

- PVC and carpet flooring with a thickness of 3–5 mm

Product information

- Elastic soft lip ensures flexible fitting
- Hides rough cut edges
- Flexible plastic – can easily be cut with a carpet knife or suitable scissors
- Simple to install without tools thanks to bottom self-adhesive layer
- Self-adhesive
- Self-service packaged with installation instructions

All sales outlets

- 1 PU = 10 x 1 m

Installation recommendations



Döllken skirting scissors



Döllken mitre shears



Colours



1054 grey



0110 Black

Double frame edge strip SK

Self-adhesive

Suitable for the following flooring types

- PVC and carpet flooring

Product information

- Elastic soft lip ensures flexible fitting
- Hiding rough cut edges
- Very easy to cut using a carpet knife or suitable scissors
- Simple to install without tools thanks to bottom self-adhesive layer
- Flexible plastic
- Self-service packaged with installation instructions

All sales outlets

- 1 PU = 10 x 1 m

Installation recommendations



Döllken skirting scissors



Döllken mitre shears

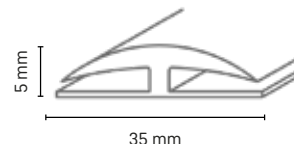

Colours



0875 sand brown



1065 brown



1054 grey



0110 Black



0130 beige

Plastic transition strip



Product information

- Robust transition strip made of extra-hard plastic
- Cut to size using fine toothed saw
- Easy to screw on using the included screws and plugs
- Covers uneven cut edges of floor coverings and the transition is protected over the long term
- Large range of colours renders design flexible
- SS pack with installation instructions, including dowels and colour-matching screws

Installation recommendations



Döllken skirting scissors



Döllken mitre shears



32 mm

All sales outlets

- SS: 1 PU = 10 x 1 m

Colours



0130 beige



1054 grey



1065 brown



0110 Black

Transition strip SK



Self-adhesive

Product information

- Flexibly adapts thanks to soft elastic lip to 3–5 mm thick PVC and carpet flooring material
- Hides rough cut edges
- Very easy to cut using a carpet knife or suitable scissors thanks to flexible plastic
- Easy to install: Self-adhesive layer on the bottom
- Self-service pack with installation instructions

Installation recommendations



Döllken skirting scissors



Döllken Gehrungsschere

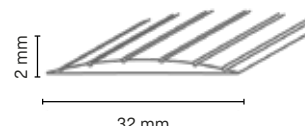

2 mm

32 mm

All sales outlets

- 1 PU = 10 x 1 m

Colours



1054 grey



0875 sand brown



1065 brown

Tools – For a great finish and perfect attachment



With the help of our Döllken team specialists you'll easily master the toughest challenges

The tools made by Döllken Profiles are unique and come with a range of characteristics and advantages:

- Help speed up installation
- Excellent quality results
- An extensive range of tried-and-tested tools
- Our hot melt adhesive gun ensures rapid, clean and excellent attachment of our products

Overview of tools

	Page
Notch punch type 2001	114
Punch accessories: clamping lever XL and press-on inserts	115
Punch accessories: Support blocks	115
Toolbox sets	116
Hot melt guns	118
Adjustable LVT strip cutter	120
Replacement blades for the LVT strip cutter	120
Notching pliers	121
Special marker for skirting installation	122
Dry adhesive strips	122
Easy-Scooter	124
Installation hammer	124
Skirting scissors	125
Mitre shears	125
Parquet set	126
Tapping block for parquet laying	126
Pull bar for parquet laying	126
Wooden wedges for parquet laying	127
Plastic wedges grooved	127
Tensioning strap for parquet laying	127

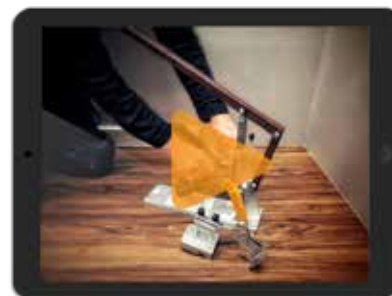

Subscribe to our channel and do not miss new videos!

Notch punch type 2001 for all Döllken solidcore skirtings



All skirtings that can be processed with the punch are labelled with this icon.

Product information

- For the punching of Döllken solidcore skirting;
- simply, efficiently and seamlessly make snug fits for outer, inner corners and end caps
- Just add on the clamping lever XL* and it can be used for the processing of 16 mm core skirtings [Cubu flex life XL and Hamburger Style]
- Punch sites readily identified with the help of the new measuring template
- Accessories such as tool case, inserts for punching decorative infill strips specifically for the solidcore skirtings D 60 and C 60 are also available

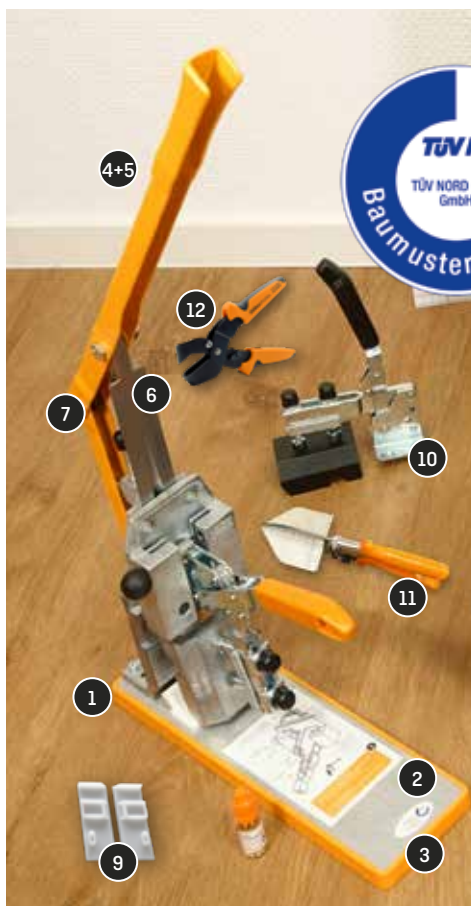

No.	Döllken punch designations	Article no.
1	Notch punch type 2001	5112900
2	Base plate for punch type 2001	5106890
3	Protective cover	5116321
4+5	Sprung lever for punch type 2001	5106894
6	Replacement blade for punch type 2001	5112706
7	Replacement spring for punch type 2001	5106897
8	Measuring template for punch type 2001	5116558
9	Press-on punch inserts for use with decorative floorings	5105434
10	Clamping lever XL for punch type 2001	5111423
11	Mitre shears for 45° angle cuts	5126064
12	Notching pliers	5124984
13	Punch case (for tool only) (empty)	5903192
NEW	Mini measuring template	5127415



Installation made even easier with the new measurement template.

- The punch and measurement template come in the matching case and also in our toolbox sets.
- Replacements for individual parts of our punch can be ordered.

Punch accessories: Clamping lever XL and press-on inserts

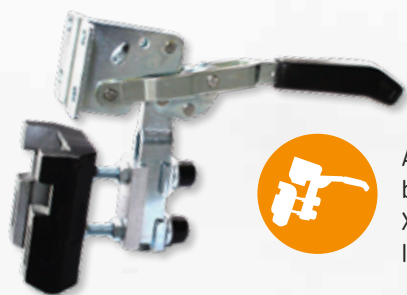

All skirtings that can be processed with the XL clamping lever are labelled with this icon.



Press-on inserts
For decorative flooring



Press-on inserts for
HSL (see page 53)

Product information

Clamping lever XL

- For accurately angled cuts – quick and clean
- Ideal for skirtings with a 16 mm core to provide additional overlap
- Black lever: Cubu XL, the Hamburger Style range

Press-on inserts

- It is advisable to first test suitability before punching decorative floorings with heterogeneous designs and soft backing
- The press-on inserts can be used for the easy insertion of infill strips seamlessly for adhesion in profiles



Punch accessories: Support blocks



Art. no. 5105884

Product information

- For the optimal positioning of solidcore skirting for punching
- Suitable for the following solidcore skirtings: EP flex life, Cubu flex life, Cubu flex life XL, Cubu flex life Premium, Hamburger Style
- Profiles with a 5 mm core can be punched without the support blocks
- Also available as an upgrade

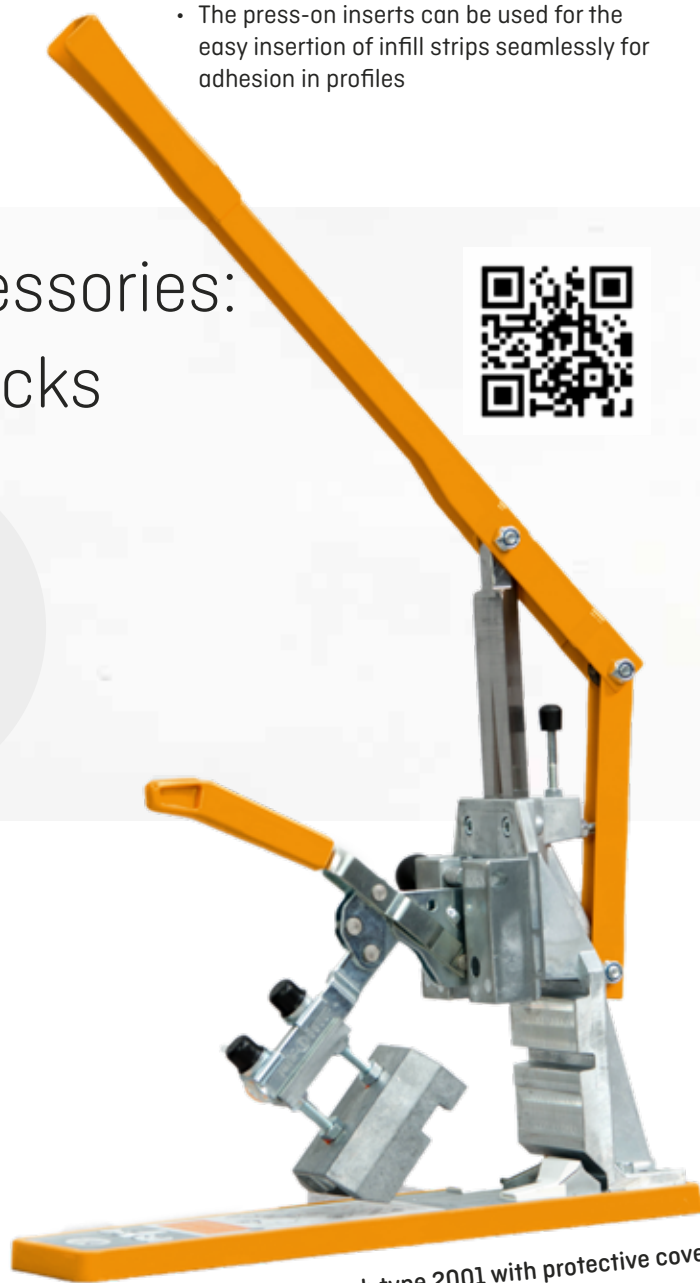

Notching punch type 2001 with protective cover

Toolbox sets

Our toolbox sets are available in seven versions:

1 PUNCHING/CUTTING SYSTEM SET CASE "COMPLETE SET"

Consists of:

- ✓ System toolbox
- ✓ Thermoforming insert for punching/cutting
- ✓ Punch with protective cover [assembled]
- ✓ Clamping lever XL
- ✓ Skirting scissors
- ✓ Mitre shears
- ✓ Notching pliers
- ✓ Press-on inserts for decorative flooring
- ✓ Information and instruction leaflet
- ✓ Press-on inserts for HSL
- ✓ Oil bottle
- ✓ Measuring template new 80cm length
- ✓ Mini measuring template
- ✓ Folding rule
- ✓ Special marker for skirting boards
- ✓ LVT strip cutter
- ✓ Replacement blades for LVT cutter
- ✓ Installation hammer

Art. no.: 5127948



2 PUNCHING/CUTTING SYSTEM SET CASE "PUNCHING"

Consists of:

- ✓ System toolbox
- ✓ Thermoforming insert for punching/cutting
- ✓ Punch with protective cover [assembled]
- ✓ Measuring template new 80cm length
- ✓ Mini measuring template
- ✓ Information and instruction leaflet

Art. No.: 5127944



3 PUNCHING/CUTTING SYSTEM CASE "EMPTY"

Consists of:

- ✓ System toolbox
- ✓ Thermoforming insert for punching/cutting

Art. No.: 5127949



General

Load-bearing capacity lid	100 kg
Loading capacity	25 kg
Load-bearing capacity front handle	40 kg
Splash-proof	yes
Temperature tolerance range	-20° to +80°
Certificate	REACH (EC 1907/2006)



External dimensions

Width	607 mm
Depth	394 mm
Height	178 mm



Internal dimensions

Width	570 mm
Depth	347 mm
Height	133 mm



Volume

30.1 l



Weight

3.2 kg

Case technical data

4 GLUING SYSTEM SET CASE "HKP 330"

Consists of:

- ✓ System toolbox
- ✓ Thermoforming insert for gluing
- ✓ HKP 330
- ✓ Four transparent adhesive sticks
- ✓ Information and instruction leaflet

Art. no.: 5127947

Other compartments provided for the storage of:

- ✓ Open-end spanner
- ✓ Superglue
- ✓ Spare nozzles
- ✓ Assembly gloves
- ✓ Protective gloves



5 GLUING SYSTEM SET CASE "HKP 2.0 E"

Consists of:

- ✓ System toolbox
- ✓ Thermoforming insert for gluing
- ✓ HKP 2.0 E
- ✓ Four transparent adhesive sticks
- ✓ Allen key 2.5 mm
- ✓ Information and instruction leaflet

Art. No.: 5127946

Other compartments provided for the storage of:

- ✓ Open-end spanner
- ✓ Superglue
- ✓ Spare nozzles
- ✓ Assembly gloves
- ✓ Protective gloves



6 GLUING SYSTEM SET CASE "HKP 220"

Consists of:

- ✓ System toolbox
- ✓ Thermoforming insert for gluing
- ✓ HKP 220
- ✓ Four transparent adhesive sticks
- ✓ Information and instruction leaflet

Art. No.: 5127945

Other compartments provided for the storage of:

- ✓ Open-end spanner
- ✓ Superglue
- ✓ Spare nozzles
- ✓ Assembly gloves
- ✓ Protective gloves



7 GLUING SYSTEM SET CASE "EMPTY"

Consists of:

- ✓ System toolbox
- ✓ Thermoforming insert for gluing

Art. no.: 5127950



Hot melt guns



The hot melt glue guns from Döllken are particularly suitable for the professional, fast and precise bonding of skirting boards.



HKP Technical data:

	HKP 220	HKP 2.0 E	HKP 330	HKP Home
Processing temperature	210-220 °C	200 °C	200 °C	200 °C
Suitable for	18 mm adhesive sticks	18 mm adhesive sticks	18 mm adhesive sticks	11 mm adhesive sticks
Operating voltage	220-240 V	220-240 V	220-240 V	220-240 V
Frequency	50 Hz	50 Hz	50 Hz	50 Hz
Weight	1,010 g	1,100 g	1,200 g	700 g
Output	600 W	600 W	600 W	200 W
Adhesive capacity	1,400-2,000 g/h	3,500 g/h 58 g/min	3,500 g/h	960 g/h
Heating time	10 minutes	4 minutes	6 minutes	2 minutes
Cable length	4.5 m	4.2 m	4.7 m	1.8 m
Case	New case system	New case system	New case system	Small case
Nozzles	Offset special nozzle (replaceable)	Offset special nozzle (replaceable)	Offset special nozzle (replaceable)	Leak-free special nozzle Ø 3 mm (replaceable)
Special features		<ul style="list-style-type: none"> · LED status display with temperature control · Electronic draw-in of adhesive sticks · Two performance settings for regulation of quantity of adhesive 	<ul style="list-style-type: none"> · Patented manual lever mechanism · Fully electronic control · Digital temperature control above display 	<ul style="list-style-type: none"> · Small, convenient, lightweight



Scan now and watch our tools in use:
youtube.com/DöllkenProfilesGmbH

An unbeatable team



Container can be refilled with available foil pouches

Hot melt adhesive
HKS 18/300 transparent
Art. no.: 5105424



Hot melt gun
HKP 220
Art. no.: 5105420

Why you should only use Döllken hot melt adhesive.

If Döllken adhesive is not used, the hot melt gun can be damaged, even beyond repair. The adhesives of other manufacturers contain other components and have different melting points and can thus enter the conveying chamber and clog the mechanical system there. In addition, there will be deficiencies in terms of processing as other adhesives do not have the same adhesive qualities and may cause extensive dripping.

- You will be unable to claim under guarantee if you use other adhesive sticks.
- You can recognise Döllken adhesive sticks from the UV strip in the centre of the transparent sticks.
- All our adhesive sticks are sold exclusively under the name "Döllken".

Important information

Only the appropriate Döllken hot melt adhesives should be used with the Döllken hot melt gun.



- All skirtings and profiles that can be processed using our hot melt adhesive are labelled with this icon.



All gluing system cases at a glance:

Description	Article no.
Set case "HKP 220"	5127945
Set case "HKP 2.0 E"	5127946
Set case "HKP 330"	5127947
HKP Home	5127639
Hot melt adhesive sticks HKS 18/300 (transparent)	
• 1 PU: 1 plastic container 5 kg (66 sticks)	5105424
• 1 PU: 5 foil bags each containing 2 kg (27 sticks) = 10 kg	5105422
Hot melt adhesive sticks HKS 11/200 (transparent)	
• 1 PU: 10 sticks	5119854
Replacement nozzle	5105884

Replacement parts for hot melt guns:



Replacement nozzle
Art. no. 5105884

Adjustable LVT strip cutter



Simple and accurate adjustment



Product information

- Suitable for the cutting of decorative strips for various Döllken profiles (appropriate codes provided on each strip cutter)
- Easily adjustable in a few simple steps from 38 to 140 mm width
- Stable fixing of adjusted width
- Suitable for cutting decorative infill strips for the skirtings D 60, C 60 and C 100
- in the punching/cutting "complete set" system case or available individually
- Art. no.: 5120310



All products that can be processed with the strip cutter are labelled with this icon.



NOW NEW:

in the punching/cutting "complete set" system case or available individually.

Replacement blades for the LVT strip cutter

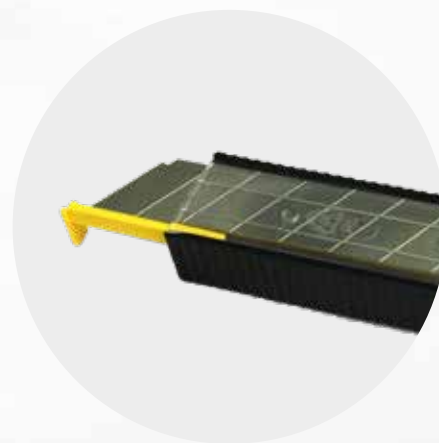
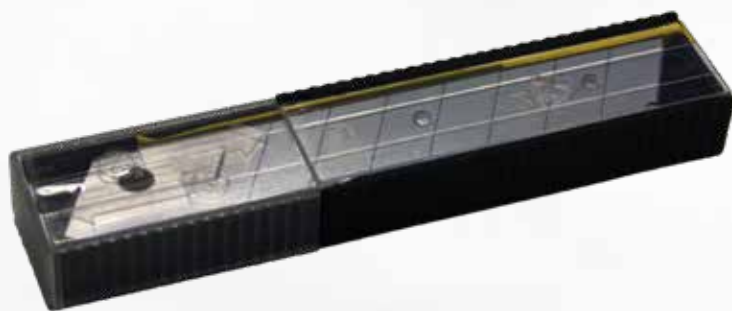

Product information

- The blade finish and additional coating increase service life and facilitate accurate cutting
- Practical dispenser so that replacement blades are always to hand – safe and simple removal
- One unit provided with the large punching set
- 1 PU = flip box containing 10 units
- Art. no.: 5901530



Scan now and watch
the strip cutter in use:



Notching pliers



With the notching pliers, gaps for cables can be readily cut in the new Cubica Light System 80.

Product information

- For cutting gaps for cables in cable duct plastic profiles, e.g. basic profiles Cubica LS and GP 20, S 60 flex life/S 100 flex life / KSO / TS 60 C 60 / D 60, C 100, HSL 6/8/10, USL 60
- Also suitable for cutting gaps in plastic housings using for electrical and sanitary installations
- For cutting gaps in adhesive LVT or other floorings for heating pipes
- Cleanly cut edges, exact cutting of soft lips on skirting
- Good handling, pliers open automatically
- Ergonomic grip providing a good level of comfort and control during use
- Art. no.: 5124984

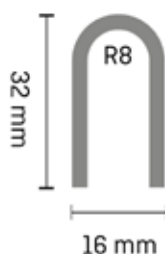

- Cutting width: 16 mm
- Cutting depth: 32 mm
- Length: 190 mm
- Weight: 460 g



Gaps for heating pipes

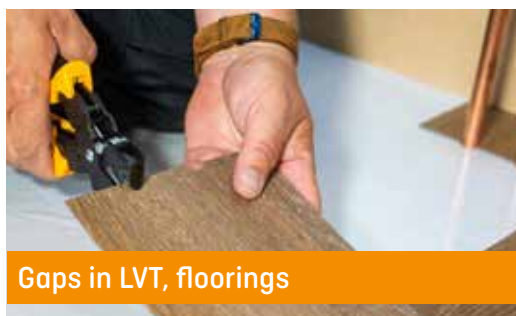

Gaps in LVT, floorings



Gaps for cables



All products that can be processed with the notching pliers are labelled with this icon.

Special marker for skirting board installation



Product information

- Can be wiped away with a dry cloth
- Line width: 1 mm
- Colour: black
- Can be used on plastics
- One marker included in all toolbox sets as a replacement for the pencil
- 1 PU: 25 units
- Art. no.: 5125238

Also available in stand pack with 25 markers!

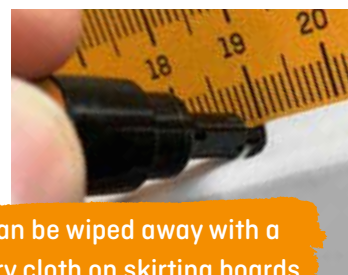

Can be wiped away with a dry cloth on skirting boards



Dry adhesive strips



Scan now and watch dry adhesive strips in use:



Dry adhesives strips are not part of the stock held by Döllken; please enquire at your local wholesaler.



Product information

- We recommend the use of the adhesive strips made by UZIN (Toptac 35, Remur, Pomur and Contact 40) for the installation of many of our skirtings.
- The strips made by UZIN are perfectly designed for the mounting of Döllken skirtings. They guarantee secure, professional mounting.



All products that can be mounted using UZIN adhesive strips are labelled with this icon.

Floorboard



Product information

- Ideal for when laying floors and tiles, grouting and painting
- FLOORBOARD, the indestructible rolling knee rest, is a must for all professionals who have to work while kneeling.
- You will be able to work for hours without tiring

What are the advantages?

- Gentle on knees and back
- Versatile in use and optimal manoeuvrability
- Very sturdy construction

Technical data:

- Size: 57 x 33 x 9 cm [L x W x H]
- Load-bearing capacity: to 150 kg
- Weight: approx. 4 kg



Other possible uses:

- Stand for containers: 30 x 40 cm [L x W]
- Holder for stirring pots up to 31.5 cm diameter

- Art. no.: 5112265

Spare parts for the Floorboard:



Foam pad
Art. no.: 5113929



Spare castors
Art. no.: 5113928

i

If you require repair of our tools, please contact your local wholesaler or specialist retailer.

Easy-Scooter



The Easy-Scooter is supplied without tools and flexible skirting!

i

You will find the skirting scissors and the installation hammer on the following pages and page 125 and the flexible skirtings from page 86.

Product information

- Roller for the rapid and precise installation of flexible skirtings
- This indestructible roller is a must for every installer of flexible skirting products
- Art. no.: 5114160

What are the advantages?

- Easy, fast and smooth dispensing of flexible skirting from the roll
- Versatile in use and optimal manoeuvrability
- Attachment option for laying tools (rubber hammer/skirting board scissors)
- Very sturdy construction



All products that can be mounted using the Easy-Scooter are labelled with this icon.

Technical data:

- Size: ø 50 cm
- Load-bearing capacity: up to 50 kg
- Weight: approx. 5 kg (excluding flexible skirting roll and tool)



Other potential applications:

- Dispensing of edge insulating strips, cable, wire etc.

Installation hammer



Product information

- Practical rubber hammer for the installation of skirtings
- The necessary adhesion is promoted by striking the profiles during installation
- Stable construction (professional quality)
- The white rubber head with small diameter does not leave marks behind on profiles or floor

- The installation hammer can be purchased separately
- Art. no.: 5112806



All products that can be mounted using the installation hammer are labelled with this icon.

Skirting scissors



Spare blades
also available:
Art. no.:
5105881

Product information

- For the precise cutting of skirtings and profiles
- Cutting length: 80 mm
- Robust and durable thanks to carbon-steel blades
- Precise cutting without the use of excessive force
- Engraved length markings in millimetres/inches
- Art. no.: 5105419



All products that can be processed with the skirting scissors are labelled with this icon.

Mitre shears



NEW

Product information

- For cutting 45° angles in skirtings and profiles
- Specially designed for mitring profiles and skirting boards up to a maximum cut length of 80 mm; suitable for plastic profiles, transition strips, expansion joint profiles, tile trims, flat wooden skirtings, quarter rounds, concave profiles, decorative skirtings and more
- Engraved length markings in millimetres/inches
- Precise cutting without the use of excessive force
- Art. no.: 5126064



All products that can be processed with the mitre shears are labelled with this icon.

Spare blades
now also
available!
Art. no.:
5105881

Parquet set



Product information

- Pull bar
- Tapping block
- 24 plastic wedges

All sales outlets

- 1 PU = 6 units [SS]
- Art. no.: 5102015

Tapping block for parquet laying



Product information

- Length: 30 cm

All sales outlets

- 1 PU = 12 units [SS]
- Art. no.: 5101999

Pull bar for parquet laying



Product information

- Length: 30 cm

Alle Vertriebslinien

- 1 PU = 6 units [SS]
- Art. no.: 5102004

Wooden wedge for parquet laying



Product information

- 12 units
- With installation instructions

All sales outlets

- 1 PU = 10 units [SS]
- Art. no.: 5102009

Grooved plastic wedge



Product information

- 30 pieces per box

All sales outlets

- 1 PU = 10 x 30 units [SS]
- Art. no.: 5102012

Tensioning strap for parquet laying

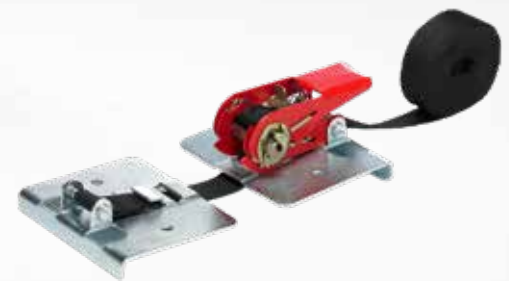

Product information

- Strap length: 5 m

All sales outlets

- 1 PU = 5 units [SS]
- Art. no.: 5102013



Kitchen profiles

Clean finish between worktop and wall

The kitchen profiles made by Döllken Profiles are unique and come with a range of characteristics and advantages:

- Decors that match many worktops
- Useful and matching accessories
- Various geometries and finishes

Overview of kitchen profiles

(Wholesale | All sales outlets)

	Page
Wall joint trim Design	130
Wall joint trim Classic	131
Kitchen base U-profile	132
Ventilation grille	132
Connectors for worktops	133
Vapour barrier	133
Multifunctional profile Top Line	134

Wall joint trim Design

NEW: Self-adhesive
and can be screw-mounted

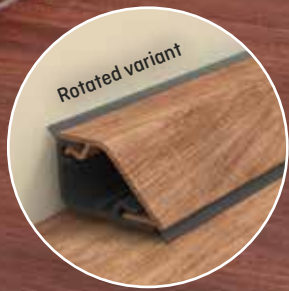

Suitable for the following flooring types

- Designed specifically for kitchen use

Product information

- Transparent, elastic sealing lip to cover gaps and joints
- Self-adhesive strips on both sides and drill holes on the base profile for easy installation
- Turn profile 90° for a larger overlap of 24 mm



Installation recommendations

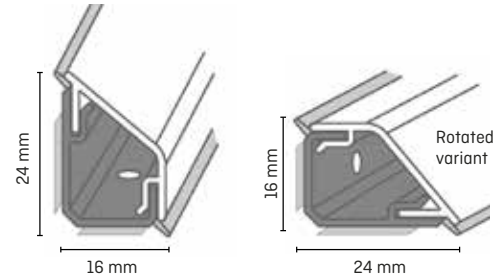
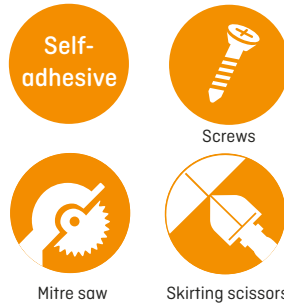

All sales outlets

- 1 PU = 6 x 3.0 m (also available in 0.6 m)

Matching
edgeband
(640 x 44 mm)
available on request!



Accessories

SS inner corner, outer corner: 1 PU = 5 x 1 units
SS end caps: 1 PU = 5 x 2 units

Colours

0117 white	1020 grey white	1087 brown	1090 grey
1063 silver	1085 beige	1010 dark brown	1091 chocolate brown
1084 sand	1086 pale brown	1089 yellow beige	1022 black



Accessories for the rotated variant are available on request!



Colours

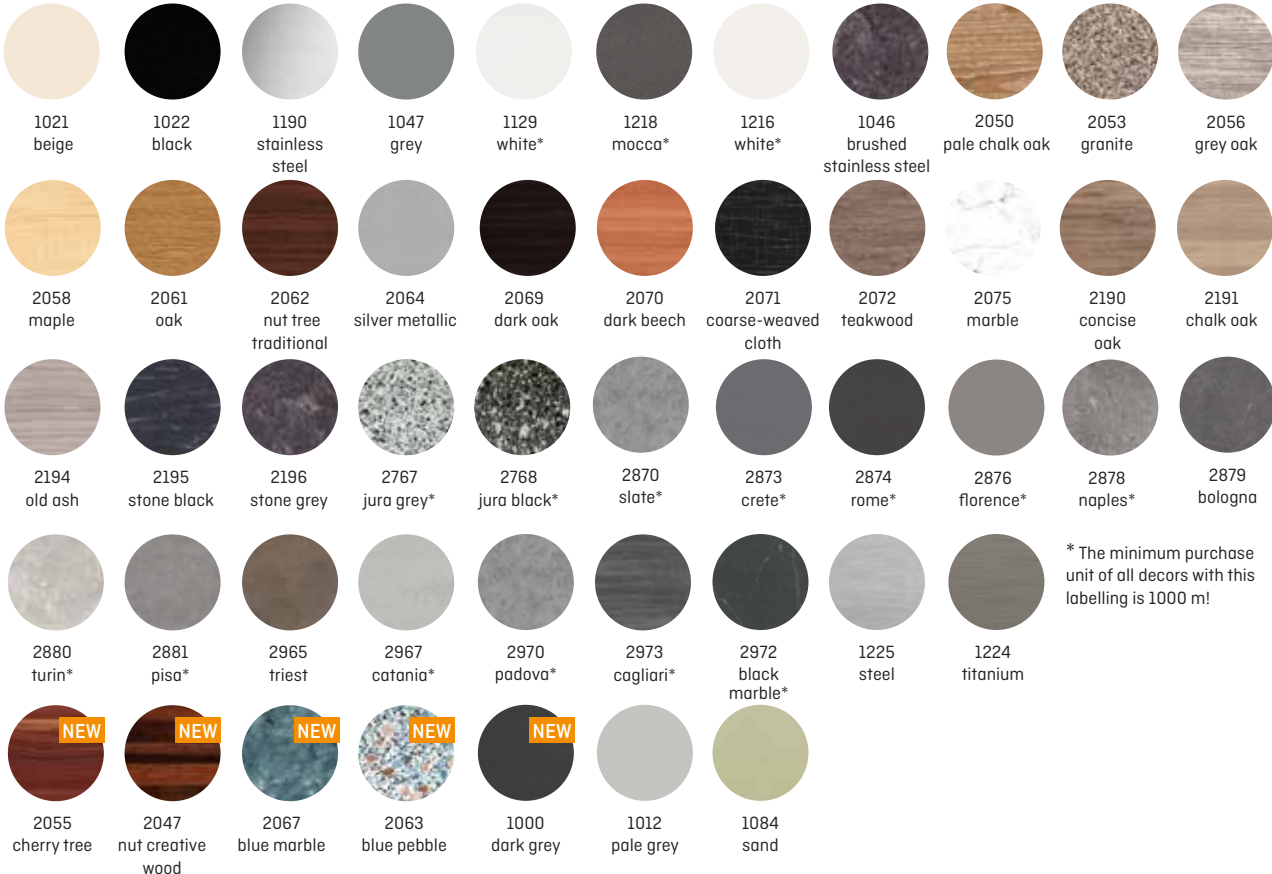

Wall joint trim Classic



Suitable for the following flooring types

- Designed specifically for kitchen use

Product information

- Optimal protection against penetration of moisture
- Fully printed surface, including sealing lips
- Colour-matched (unicolour) corners and end caps
- Available for all conventional worktops
- Two parts: base profile (for screwing to wall and worktop) and cover profile



Installation recommendations



Skirting
scissors



Screws



Mitre saw

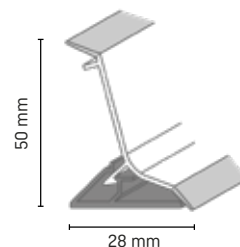

All sales outlets

- 1 PU = 10 x 3.0 m

Accessories

- Available as set
- SS: accessories set consisting of
1 PU = 10 x 5 units:
2 x inner corners (2 units), outer corner
(1 unit) and end caps (1 pair)



Inner corner 90°
2 units, plastic
SS



Outer corner 90°
1 unit, plastic
SS



End caps
1 pair, plastic
SS

Colours
white
silver-grey
sardo granite
beech

Colours



1137
white



1139
silver-grey



2310
sardo
granite



2297
beech

Kitchen base U-profile



Product information

- Plastic
- With soft lip for optimal protection against moisture and dirt
- For kitchen cabinet toe kicks
- Available in 16 mm and 19 mm

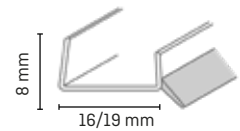

All sales outlets

- 1 PU = 20 x 2.5 m
- Art. no.: 5101716 (U-profile 16 mm) /
5101717 (U-profile 19 mm)

Colours

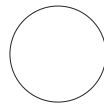

transparent

Ventilation grille



Product information

- Anodised aluminium
- For optimum air circulation under kitchen worktops and toe kicks or on doors
- Plug-in assembly makes it easily removable for cleaning.
- SS packaged with installation instructions

Dimensions

- 500 x 70 mm (external)
- 475 x 58 mm (internal)

All sales outlets

- 1 PU = 4 x 1 units
- Art. no.: 5101710

Colours



silver

Connectors for worktops



Product information

- Available lengths:
150 mm and 70 mm
- Corner and longitudinal connections
- 2 units

All sales outlets

- 1 PU = 10 x 1 units
- Art. no.: 5101718 (150 mm) /
5101721 (70 mm)

Vapour barrier



Product information

- Aluminium adhesive foil to protect the lower edge of the worktop
- area of ovens and dishwashers
- Reliably prevents swelling of the worktop by dishwasher or oven steam
- Self-adhesive

All sales outlets

- SS: 1 PU = 5 x 1 units
- Art. no.: 5110969

Dimensions

- Width: 7.5 cm
- Length: 1.0 m

Colours



aluminium

Multifunctional profile Top Line



Product information

- Versatile use: as a perfect wall connection strip in the kitchen and bathroom or e.g. for concealing horizontal and vertical joints between furniture
- Finished with a modern real metal foil
- Self-adhesive, simple installation
- Clean finish with soft lips adaptable to walls and worktops
- Hard-wearing surfaces offer a long service life, are abrasion-resistant and resistant to common household cleaning agents
- Basic profile: made of chlorine-free ABS-based polyblend and flexible soft lips made of a thermoplastic elastomer (TPE), in contact with wall and worktop.
- Cover profile: made of a chlorine-free ABS-based polyblend, covered with a real metal foil.



Installation recommendations



Mitre saw

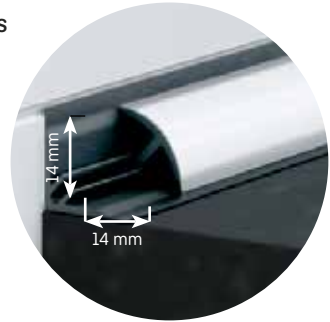

All sales outlets

- 1 PU = 10 x 2.50 m
- 1 PU = 10 x 5.00 m (only decor 1046 brushed stainless steel is available from stock; all other colours must be separately ordered)

Colours

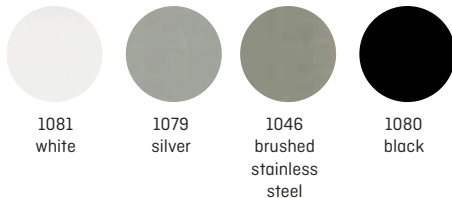

Accessory sets

- SS: 1 PU = 10 units, consisting of inner corners (4 x 90°, 2 x 135°), outer corners (2 units) and end caps (left and right, 2 pairs)



Accessories

Inner corner (90°):

- 1 PU = 10 x 10 units

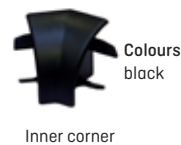

Inner corner (135°):

- 1 PU = 10 x 10 units



Outer corner:

- 1 PU = 10 x 10 units



End caps:

- 1 PU = 10 x 10 units





Other products

Useful helpers and all-round aids for daily use

Overview of other products

(All sales outlets)

Page

Joint filler set	138
Joint filler tube or cartridge	138
Joint filler cleaner	138
Decor Mix&Fill	139
Anti-slip mat	140
Anti-slip fleece	140
Adhesive edge banding	141
Trimmer for adhesive edge banding	141
Soft edging	142
Intermediate and finish trim for panels	143
Heating pipe rosette	143
Steel pins	144
Screws and dowels	144
Skirting board nails	144
Clamping dowels and fitschen pins	144
ClipStar metal type G	145
Fastening clip C	145

Profile gaps and joints
can be readily filled
with our joint filler

- ✓ Colour-stable
- ✓ Moisture-resistant
- ✓ Can be painted



Simply scan
and view use
on YouTube!



Joint filler set



All products that can be processed using the joint filler set are labelled with this icon.



Product information

- For perfect finish of white skirting boards – covers gaps and shadow joints
- Easily cover profile gaps and joints
- The paste-like one-component filler can be applied externally and adapts to all gaps
- Surplus filler material can be smoothed out or removed with a spatula and the supplied cleaner.
- Spare screw nozzles are available on request

Accessories

- Joint filler
- Cleaner
- Screw nozzle
- Spatula
- Cotton cloth
- Felt sanding block

Description	PU	Article no.
Joint filler set, box	1 x 1 unit	5115427
Joint filler spare tip	1 x 6 units	5116128
Joint filler cartridge 500 g white	6 x 1 unit	5124423
Joint filler cleaner 250 ml	12 x 1 unit	5124424
Joint filler tube white 150 g	12 x 1 unit	5124422

Joint filler tube or cartridge



Cleaner



Important note:
joint filler cleaner
may only be used on
unicolour skirtings.

i

Product information

- Joint filler is available in a practical tube (150 g) or cartridge (500 g)
- Tube (150 g): 1 PU = 12 x 1 units
- Cartridge (500 g): 1 PU = 6 x 1 units

- Cleaner in a 250 ml bottle
- 1 PU = 12 units

Decor Mix&Fill



Product information

- Repair paste for repairing minor damage to laminate floors
- With the two pigments, the base paste can be mixed to any desired color
- Content: Base tube 50 g, 2 pigment bottles 5 ml each, spatula
- SB-packed with instructions for use

Description	PU	Article no.
Decor Mix&Fill bright	6 units	5102094
Decor Mix&Fill grey&beige	6 units	5127236
Decor Mix&Fill dark	6 units	5102095

A photograph showing a square, light-colored mat with a grid of small circular holes placed on a dark wood-look parquet floor. The mat is positioned in the corner of a room, with a carpeted area visible in the background and a wooden pillar on the right.

Anti-slip mat

Product information

- Carpet underlay for smooth and hard floors
- Non-sliding grid surface
- Robust and hard-wearing
- Hygienic and breathable
- The cushioning effect lengthens the service life of carpets
- Washable at up to 30 °C
- SS packaged

Dimensions

- Width: 0.60 m
Length: 1.30 m
- Width: 0.80 m
Length: 1.50 m

All sales outlets

- 1 PU = 1 unit (SS)

A photograph showing a square, light blue-grey mat with a fine, textured surface placed on a dark wood-look parquet floor. The mat is positioned in the corner of a room, with a carpeted area visible in the background and a wooden pillar on the right.

Anti-slip fleece

Product information

- Underlay for carpets and runners on all textile floors (also suitable for hard floors)
- Stops sliding
- Suitable for underfloor heating
- Easy to cut to size
- Washable at up to 30 °C
- SS packaged

Dimensions

- Width: 0.80 m
Length: 1.50 m

All sales outlets

- 1 PU = 1 unit (SS)

Adhesive edge banding



Product information

- Reliable covering of cut edges
- Melamine resin band can be ironed-on
- Extensive range in stock; many other versions available at short notice
- SS packaged with installation instructions



All sales outlets

- 1 PU = 10 x 5 m (in 20 mm width, other widths available on request, SS packaged)

Colours



Trimmer for adhesive edge banding



Product information

- SS packaged with instruction manual

All sales outlets

- 1 PU = 8 units (SS)

Soft edging



Product information

- Ideal for curved and straight edges of shelving, boards, doors and furniture
- Uneven veneers or cut edges are elegantly concealed
- Easy to apply using contact adhesive or a hot melt gun

Available in the following sizes:

- 16 mm
- 19 mm (only available in white)



All sales outlets

- 1 PU = 10 x 1 unit (length: 2 m, SS packaged)

Colours



1137
white



0110
black

Intermediate and finish trim for panels

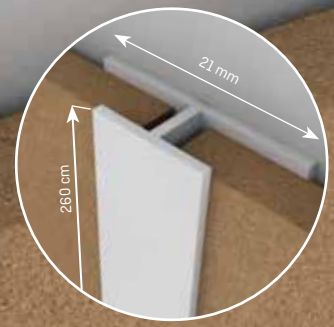

Product information

- Plastic hard
- For panel thickness up to 4.5 mm

All sales outlets

- 1 PU = 10 x 2.6 m [SS packaged]

Colours



1137
white

Heating pipe rosette



Product information

- Create a harmonious appearance of unsightly heating pipes on walls or floors
- Simply clip together to fasten securely
- Additional gluing provides more durable fixation
- SS packaged with installation instructions

Available in the following sizes:

- 18 mm
- 22 mm

All sales outlets

- 1 PU = 10 x 1 unit [SS]

Colours



white

Steel pins

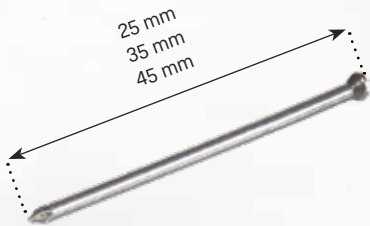

Product information

- For skirting boards
- Not galvanised
- Available lengths:
 - 25 mm, 35 mm and 45 mm

All sales outlets

- 1 PU = 20 x 100 units [SS]



All products that can be installed using steel pins are labelled with this icon.

Skirting board nails

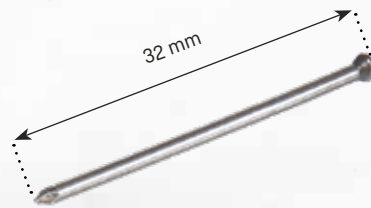

Product information

- Length: 32 mm

All sales outlets

- 1 PU = 20 x 100 units [SS]

Colours



white

maple/pine

oak/
cherry

nut tree/
mahogany

Screws and dowels



Product information

- Available lengths (screws): 25 mm,
Diameter: 5 mm

All sales outlets

- SS: 1 PU = 20 x 15 units [SS]

Colours



1063
silver

1162
brass

1161
bronze

Clamping dowels and fitschen pins



Product information

- Clamping dowels (black) for fastening
clamp-on skirting boards
- Fitschen pins (galvanised) 1.5 x 35 mm

All sales outlets

- 1 PU = 250 units (fitschen pins) [SS packaged]
- 1 PU = 100 units (dowels) [SS packaged]

ClipStar metal type G

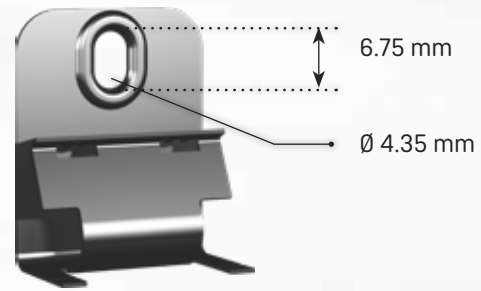

Product information

- Invisible fixing of skirting boards
- Fastening with screws and dowels
- Easy mounting

All sales outlets

- 1 PU = 10 bags à 50 units [SS packaged]
- 1 PU = 10 bags à 20 units [SS packaged]



All skirtings that can be installed with the ClipStar metal type G are labelled with this icon.

Fastening clip C



Product information

- Invisible fixing of skirting boards
USL 50 and foam skirting Classic 50
- Fastening with screws and dowels
- Easy mounting

All sales outlets

- 1 PU = 10 x 20 units [SS]

Natural sustainability!



Working in a sustainable way with resources is very important to us. An efficiency enhancement project is therefore under way at our Grammetal site. The goal, by using modern LED lighting, compressed air optimisation and recovery of waste machine heat, is to save energy and so significantly reduce CO₂ emissions. The plan is in future to reduce CO₂ emissions by some 96 tonnes annually. Funding for this project is being made available by the European Fund for Regional Development.

- **Certified quality**
- ISO 50001:2018 - Energy Management
- ISO 9001:2015 - Quality Management
- ISO 14001:2015 - Environmental Management Systems
- All materials used are REACH-compliant.
- All our solidcore skirtings are made from chlorine-free plastics, are certified in accordance with ISO 16000 and are low-emission.
- Use of PVC containing no heavy metals that are harmful to health.

Corporate responsibility for a shared future

As an internationally prominent manufacturer of high-quality plastic skirting boards, we are committed to the maintenance of outstanding quality. We continually check all well-established products with regard to composition, workmanship quality and environmental compatibility. Be it the selection of raw materials used or optimisation of the production processes – the issue of environmental friendliness is paramount for us. Our responsibility as regards sustainability continues long after our skirting boards are fitted. This is why we subscribe to certifications and continual quality checks – for a healthy living environment and ecological compatibility.



Please see our solid wood catalogue for our FSC®- and PEFC certified wooden skirtings.



Almost all products have Greenguard Gold certification. They thereby satisfy the strictest requirements pertaining to the reduction of hazardous substance emissions into the ambient air.



All our solidcore skirtings are made from chlorine-free plastics, are certified in accordance with ISO 16000 and are low-emission.



A number of our plastic skirting boards (including stair edging and flexible boards) are made only with phthalate-free plasticizers.



Nearly all solidcore and flexible skirtings in the "Life" family have been awarded the Blue Angel ecolabel.



Our soft skirting boards are EPD-certified, which means that the environmentally relevant properties of the WLK form of neutral and objective data mapped.

You can find the article numbers
for all products online!

Simply scan this QR code >>



**All article numbers
for our products**



To view important revisions to our range and the latest online version of our catalogue, please visit our website doellken-profiles.com

Döllken Profiles GmbH
Industriestrasse 1
59199 Bönen/Germany
T: +49 (711)3643 4170 0
F: +49 (330)3643 4170 0
info@doellken-profiles.com
www.doellken-profiles.com
Follow us:   